

Hong Kong Exchanges and Clearing Limited, The Stock Exchange of Hong Kong Limited and the Securities and Futures Commission take no responsibility for the contents of this Application Proof, make no representation as to its accuracy or completeness and expressly disclaim any liability whatsoever for any loss howsoever arising from or in reliance upon the whole or any part of the contents of this Application Proof.

Application Proof of

MicroTech Medical (Hangzhou) Co., Ltd.* 微泰醫療器械(杭州)股份有限公司

(a joint stock company incorporated in the People's Republic of China with limited liability)

WARNING

The publication of this Application Proof is required by The Stock Exchange of Hong Kong Limited (the “**Stock Exchange**”) and the Securities and Futures Commission (the “**Commission**”) solely for the purpose of providing information to the public in Hong Kong.

This Application Proof is in draft form. The information contained in it is incomplete and is subject to change which can be material. By viewing this document, you acknowledge, accept and agree with MicroTech Medical (Hangzhou) Co., Ltd. (微泰醫療器械(杭州)股份有限公司) (the “**Company**”), its sponsors, advisers or members of the underwriting syndicate that:

- (a) this document is only for the purpose of providing information about the Company to the public in Hong Kong and not for any other purposes. No investment decision should be based on the information contained in this document;
- (b) the publication of this document or any supplemental, revised or replacement pages on the Stock Exchange’s website does not give rise to any obligation of the Company, its sponsors, advisers or members of the underwriting syndicate to proceed with an offering in Hong Kong or any other jurisdiction. There is no assurance that the Company will proceed with the offering;
- (c) the contents of this document or any supplemental, revised or replacement pages may or may not be replicated in full or in part in the actual final listing document;
- (d) the Application Proof is not the final listing document and may be updated or revised by the Company from time to time in accordance with the Rules Governing the Listing of Securities on the Stock Exchange;
- (e) this document does not constitute a prospectus, offering circular, notice, circular, brochure or advertisement offering to sell any securities to the public in any jurisdiction, nor is it an invitation to the public to make offers to subscribe for or purchase any securities, nor is it calculated to invite offers by the public to subscribe for or purchase any securities;
- (f) this document must not be regarded as an inducement to subscribe for or purchase any securities, and no such inducement is intended;
- (g) neither the Company nor any of its affiliates, advisers or underwriters is offering, or is soliciting offers to buy, any securities in any jurisdiction through the publication of this document;
- (h) no application for the securities mentioned in this document should be made by any person nor would such application be accepted;
- (i) the Company has not and will not register the securities referred to in this document under the United States Securities Act of 1933, as amended, or any state securities laws of the United States;
- (j) as there may be legal restrictions on the distribution of this document or dissemination of any information contained in this document, you agree to inform yourself about and observe any such restrictions applicable to you; and
- (k) the application to which this document relates has not been approved for listing and the Stock Exchange and the Commission may accept, return or reject the application for the subject public offering and/or listing.

No offer or invitation will be made to the public in Hong Kong until after a prospectus of the Company has been registered with the Registrar of Companies in Hong Kong in accordance with the Companies (Winding Up and Miscellaneous Provisions) Ordinance (Chapter 32 of the Laws of Hong Kong). If an offer or an invitation is made to the public in Hong Kong in due course, prospective investors are reminded to make their investment decisions solely based on a prospectus of the Company registered with the Registrar of Companies in Hong Kong, copies of which will be made available to the public during the offer period.

* *For identification purpose only*

IMPORTANT

IMPORTANT: If you are in any doubt about any of the contents of this Document, you should obtain professional independent advice.



MicroTech Medical (Hangzhou) Co., Ltd.* 微泰醫療器械(杭州)股份有限公司

(A joint stock company incorporated in the People's Republic of China with limited liability)

[REDACTED]

- Number of [REDACTED] under : [REDACTED] H Shares (subject to the the [REDACTED] [REDACTED])
- Number of [REDACTED] : [REDACTED] H Shares (subject to reallocation)
- Number of [REDACTED] : [REDACTED] H Shares (subject to reallocation and the [REDACTED])
- [REDACTED] : HK\$[REDACTED] per H Share, plus brokerage of 1.0%, SFC transaction levy of 0.0027% and Hong Kong Stock Exchange trading fee of 0.005% (payable in full on application in Hong Kong dollars and subject to refund)
- Nominal value : RMB1.00 per H share
- [REDACTED] : [●]

Joint Sponsors, [REDACTED]

**Goldman
Sachs**



Hong Kong Exchanges and Clearing Limited, The Stock Exchange of Hong Kong Limited and Hong Kong Securities Clearing Company Limited take no responsibility for the contents of this Document, make no representation as to its accuracy or completeness and expressly disclaim any liability whatsoever for any loss howsoever arising from or in reliance upon the whole or any part of the contents of this Document.

A copy of this Document, having attached thereto the documents specified in the section headed “Appendix VII – Documents Delivered to the Registrar of Companies and Available for Inspection” in this Document, [has been] registered by the Registrar of Companies in Hong Kong as required by Section 342C of the Companies (Winding Up and Miscellaneous Provisions) Ordinance, Chapter 32 of the Laws of Hong Kong. The Securities and Futures Commission of Hong Kong and the Registrar of Companies in Hong Kong take no responsibility as to the contents of this Document or any other documents referred to above.

The [REDACTED] is expected to be determined by agreement between the [REDACTED] (on behalf of the [REDACTED]) and us on the [REDACTED]. The [REDACTED] is expected to be on or around [REDACTED] (Hong Kong time) and, in any event, not later than [REDACTED] (Hong Kong time). The [REDACTED] will not be more than HK\$[REDACTED] per [REDACTED] and is currently expected to be not less than HK\$[REDACTED] per [REDACTED]. If, for any reason, the [REDACTED] is not agreed by [REDACTED] (Hong Kong time) between the [REDACTED] (on behalf of the [REDACTED]) and us, the [REDACTED] will not proceed and will lapse.

The [REDACTED], on behalf of the [REDACTED], may, where considered appropriate and with our consent, reduce the number of [REDACTED] and/or the indicative [REDACTED] below that is stated in this Document (which is HK\$[REDACTED] to HK\$[REDACTED]) at any time prior to the morning of the last day for lodging applications under the [REDACTED]. In such case, notices of the reduction in the number of [REDACTED] and/or the indicative [REDACTED] will be published on the website of our Company at www.microtechmd.com and on the website of the Hong Kong Stock Exchange at www.hkexnews.hk as soon as practicable following the decision to make such reduction, and in any event not later than the morning of the last day for lodging applications under the [REDACTED]. Further details are set forth in the sections headed “Structure of the [REDACTED]” and “How to Apply for [REDACTED]” in this Document.

We are incorporated, and a majority part of our businesses are located, in the PRC. Potential [REDACTED] should be aware of the differences in the legal, economic and financial systems between the PRC and Hong Kong and that there are different risk factors relating to [REDACTED] in PRC-incorporated businesses. Potential [REDACTED] should also be aware that the regulatory framework in the PRC is different from the regulatory framework in Hong Kong and should take into consideration the different market nature of the H Shares. Such differences and risk factors are set out in the sections headed “Risk Factors,” “Regulatory Overview” and “Appendix V – Summary of Articles of Association” in this Document.

The obligations of the [REDACTED] under the [REDACTED] are subject to termination by the [REDACTED] (on behalf of the [REDACTED]) if certain events occur prior to 8:00 a.m. on the [REDACTED]. Please refer to the section headed “[REDACTED]” in this Document.

The [REDACTED] have not been and will not be registered under the U.S. Securities Act or any state securities law in the United States and may be [REDACTED] and [REDACTED] only (a) in the United States to “Qualified Institutional Buyer” in reliance on Rule 144A or another exemption from, or in a transaction not subject to, registration under the U.S. Securities Act and (b) outside the United States in offshore transactions in reliance on Regulation S under the U.S. Securities Act.

[REDACTED]

* For identification purpose only

[REDACTED]

IMPORTANT

[REDACTED]

IMPORTANT

[REDACTED]

EXPECTED TIMETABLE⁽¹⁾

[REDACTED]

EXPECTED TIMETABLE⁽¹⁾

[REDACTED]

EXPECTED TIMETABLE⁽¹⁾

[REDACTED]

CONTENTS

IMPORTANT NOTICE TO PROSPECTIVE [REDACTED]

This Document is issued by us solely in connection with the [REDACTED] and the [REDACTED] and does not constitute an [REDACTED] to sell or a solicitation of an [REDACTED] to buy any security other than the [REDACTED] by this Document pursuant to the [REDACTED]. This Document may not be used for the purpose of making, and does not constitute, an [REDACTED] or invitation in any other jurisdiction or in any other circumstances. No action has been taken to permit a [REDACTED] of the [REDACTED] in any jurisdiction other than Hong Kong and no action has been taken to permit the distribution of this Document in any jurisdiction other than Hong Kong. The distribution of this Document for purposes of a [REDACTED] and the [REDACTED] and sale of the [REDACTED] in other jurisdictions are subject to restrictions and may not be made except as permitted under the applicable securities laws of such jurisdictions pursuant to registration with or authorization by the relevant securities regulatory authorities or an exemption therefrom.

You should rely only on the information contained in this Document to make your [REDACTED] decision. The [REDACTED] is made solely on the basis of the information contained and the representations made in this Document. We have not authorized anyone to provide you with information that is different from what is contained in this Document. Any information or representation not contained nor made in this Document must not be relied on by you as having been authorized by us, the Joint Sponsors, the [REDACTED], the [REDACTED], any of the [REDACTED], any of our or their respective directors, officers, employees, agents, or representatives of any of them or any other parties involved in the [REDACTED].

	<i>Page</i>
Expected Timetable	i
Contents	iv
Summary	1
Definitions	19
Glossary of Technical Terms	32
Forward-Looking Statements	37
Risk Factors	39
Information about this Document and the [REDACTED]	101
Waivers from Strict Compliance with the Listing Rules and Exemption from Strict Compliance with the Companies (Winding Up and Miscellaneous Provisions) Ordinance.	106

CONTENTS

Directors, Supervisors and Parties Involved in the [REDACTED]	114
Corporate Information	119
Industry Overview	121
Regulatory Overview	144
History, Development and Corporate Structure	164
Business	195
Directors, Supervisors and Senior Management	267
Relationship with our Single Largest Group of Shareholders	291
Substantial Shareholders	295
Share Capital	299
Financial Information	303
Future Plans and Use of [REDACTED]	341
[REDACTED]	344
Structure of the [REDACTED]	356
How to Apply for [REDACTED]	368
Appendix I Accountants’ Report	I-1
Appendix II [REDACTED]	II-1
Appendix III Taxation and Foreign Exchange	III-1
Appendix IV Summary of Principal Legal and Regulatory Provisions	IV-1
Appendix V Summary of Articles of Association	V-1
Appendix VI Statutory and General Information	VI-1
Appendix VII Documents Delivered to the Registrar of Companies and Available for Inspection	VII-1

SUMMARY

This summary aims to give you an overview of the information contained in this Document. As it is a summary, it does not contain all the information that may be important to you. You should read the whole document before you decide to [REDACTED] in the [REDACTED]. In particular, we are a biotechnology company seeking to [REDACTED] on the Main Board of the Hong Kong Stock Exchange under Chapter 18A of the Listing Rules on the basis that we are unable to meet the requirements under Rule 8.05(1), (2) or (3) of the Listing Rules. There are unique challenges, risks and uncertainties associated with [REDACTED] in companies such as ours. In addition, we have incurred net losses since our inception and we may incur net losses for the foreseeable future. We had negative net cash flow from operating activities during the Track Record Period. We did not declare or pay any dividends during the Track Record Period and may not pay any dividends in the near future. Your [REDACTED] decision should be made in light of these considerations.

There are risks associated with any [REDACTED]. Some of the particular risks in [REDACTED] in the [REDACTED] are set out in the section headed “Risk Factors” in this Document. You should read that section carefully before you decide to [REDACTED] in the [REDACTED].

OVERVIEW

We are a pioneer in the diabetes management medical devices industry that innovates and integrates the treatment and monitoring of diabetes to reshape the diabetes management paradigm in China and globally. We are the only company that has commercialized both patch insulin delivery system and calibration-free continuous glucose monitoring system (“CGMS”) in the world, according to the CIC Report. We believe that our comprehensive and market-leading product portfolio, our advanced positioning in the development of closed loop solutions, our deeply integrated treatment and monitoring platform created through robust R&D, manufacturing and commercialization capabilities, together with our visionary management team, significantly differentiate us from our peers. We are dedicated to helping people with diabetes lead healthier lives. Our long-term mission is to become the global leader in diabetes management.

Diabetes is one of the most prevalent chronic diseases in the world, which is often ill-managed due to lack of effective insulin delivery and glucose monitoring. According to the CIC Report, the global prevalence of diabetes was 486.9 million people in 2019 and is expected to reach 607.6 million people in 2030. According to the same source, the prevalence of diabetes in China was 118.8 million people in 2019 and is expected to reach 143.2 million people in 2030. The global market size of diabetes management medical devices is expected to increase from US\$47.8 billion in 2020 to US\$111.1 billion in 2030, representing a CAGR of 8.8%, with the Chinese market alone to increase from US\$2.4 billion in 2020 to US\$9.5 billion in 2030, representing a CAGR of 14.7%. Meanwhile, there are significant unmet clinical needs for medical devices that can operate on a real-time and continuous basis to lower the risks of hypo/hyper-glycaemia and offer significant short-term and long-term benefits to patients.

SUMMARY

Manufacturers are required to have multi- and cross- disciplinary capabilities for the R&D of such innovative medical devices. To capitalize this market opportunity, we were founded in 2011 with the objective to reshape the diabetes monitoring, treatment and management paradigm through closed loop solutions that dynamically monitor and control the blood glucose level. Over the last ten years, we have strategically developed a robust and comprehensive product portfolio across multiple product lines, including patch insulin pump system and CGMS, which form the basis of the closed loop artificial pancreas, as well as IVD devices, such as BGMS and POCT devices.

Equil Patch Insulin Pump System (“**Equil**”), our Core Product, is the second commercialized semi-disposable patch insulin pump globally, and the first and only domestically developed patch insulin pump approved in both China and the EU. Compared to traditional tubed pumps, Equil features a tubeless and lightweight design, enabling users to manage diabetes discreetly and safely. Other innovative attributes include a vibration alert that users can feel underneath their clothing and a dedicated bolus button that can initiate insulin delivery without the remote control. Furthermore, Equil has comparable or better performance than major peer products, with improved safety, better accuracy and semi-disposability. In September 2017, Equil received the marketing approval for adult use from the NMPA in China. Equil also received CE marking in the EU in the same year. As of the Latest Practicable Date, we had successfully marketed Equil in over 15 countries across Asia Pacific, Europe, Middle East, Africa and Latin America. In February 2021, we submitted a 510(k) premarket notification to the FDA and we expect to receive FDA clearance for Equil in the first half of 2022.

AiDEX G7, our CGMS, is the second commercialized calibration-free real-time CGMS in the world. Since its launch, AiDEX G7 has demonstrated various advantages over traditional blood glucose monitoring systems (“**BGMS**”), featuring real-time monitoring, reduced risk of hyper/hypoglycemia, and increased compliance to treatment regimen without taking routine finger prick blood glucose measurements. AiDEX G7 also performs better than, or on par with, global peer products in terms of accuracy, calibration, usage time and transmitter life. AiDEX G7 received CE marking in the EU in September 2020. We completed a clinical trial for AiDEX G7 in China in May 2020 and the NMPA accepted our registration application in the first quarter of 2021. AiDEX G7 has been certified by the NMPA in May 2020 to be eligible for the Special Approval Procedures of Innovative Medical Devices promulgated by the NMPA. When approved, AiDEX G7 is expected to be the first calibration-free real-time CGMS approved for commercialization in China.

SUMMARY

Besides Equil and AiDEX G7, we have developed a robust pipeline of product candidates with improved features, including our closed loop artificial pancreas, second-generation patch insulin pump system, AiDEX X and IVD devices. The following chart summarizes the development status of our products and major product candidates:

Product Line	Product	Major Markets	Preclinical	Clinical	Registration	Commercialization	Expected Completion of Current Stage	Expected Commercial Launch
Patch Insulin Pump System	Equil * (for adult use)		[Progress bar]				N/A	Launched
			[Progress bar]				N/A	Launched
	Equil * (for child and adolescent use) Second-Generation Patch Insulin Pump System*		[Progress bar]				1H 2022	1H 2022
			[Progress bar]				2H 2021****	1H 2022****
Continuous Glucose Monitoring System	AiDEX G7 (for adult use)		[Progress bar]				2H 2021	2H 2021
			[Progress bar]				N/A	Launched
			[Progress bar]				1H 2022	1H 2023
	AiDEX G7 (for child and adolescent use)		[Progress bar]				2H 2021****	1H 2023****
AiDEX X		[Progress bar]				2H 2021****	1H 2023****	
Closed Loop Artificial Pancreas	PanCares Artificial Pancreas*		[Progress bar]				1H 2022****	2H 2023****
	Cloud-based AI-powered Artificial Pancreas		[Progress bar]				2023****	Post 2024****
IVD	BGMS Products**		[Progress bar]				N/A	Launched
	Exactive Pro Glucose, Ketone, Uric Acid Monitoring System		[Progress bar]				2H 2021	1H 2022
	IVocare Multifunctional POCT		[Progress bar]				2H 2021	2H 2021

* Core Product: further R&D includes indication expansion to children and adolescents, and product improvement including the development of second-generation patch insulin pump system and artificial pancreas.
▲ Eligible for NMPA Special Approval Procedures of Innovative Medical Devices
* Development of second-generation patch insulin pump system and artificial pancreas is part of the further R&D plans of our Core Product, which are expected to improve the features of our Core Product.
** Including multiple types of blood glucose meters and test strips approved for commercialization in China, the EU and/or the US
*** For commercialization in China and the EU
**** For commercialization in China

As we build up our product pipeline, we have developed a deeply integrated treatment and monitoring platform with robust R&D, manufacturing and commercialization capabilities.

- R&D.** We had a proven record of R&D experience. We were designated as the Key Diabetes Research Center in Zhejiang Province, China, and we had also established a R&D center in Silicon Valley. Equil, our Core Product, was designated as an Innovative Medical Device Product by the PRC Ministry of Science and Technology. Led by Dr. Zheng Pan, our Chief Executive Officer, who has nearly 20 years of experience in the healthcare industry, we have formed a robust R&D team with extensive industry experience and multidisciplinary capabilities. We remain at the forefront of innovation by maintaining close contact with leading medical professionals and key opinion leaders (“KOLs”) and develop products that specifically address the unmet clinical needs. Our superior R&D capabilities will allow us to pioneer the development of high-quality closed loop solutions, patch insulin pump systems and CGMS products in a cost-effective manner.
- Manufacturing.** We conduct all the key manufacturing procedures in-house. Over the years, we have accumulated extensive expertise and know-how in manufacturing diabetes management medical devices, which sets a solid foundation for our long-term growth. We own manufacturing facilities with an aggregate area of approximately 15,000 sq.m. in Hangzhou, China, including a 1,500 sq.m. ISO Class 7 clean-room space and an 80 sq.m. ISO Class 8 clean-room space. We uphold manufacturing quality management, and have received major international certifications. Our emphasis on the automatic and continuous control of manufacturing processes also significantly contributes to the improvement of our overall production quality and efficiency.

SUMMARY

- *Commercialization.* We strategically use a combination of our in-house sales and marketing team and a broad network of independent distributors to sell our products in China and overseas. We had 370 distributors as of December 31, 2020 and over 120 in-house sales and marketing personnel as of the Latest Practicable Date, covering the sales of our products across 30 provinces, municipalities and autonomous regions in China, and over 60 countries overseas. We have developed a global footprint in Asia Pacific, Europe, Middle East, Africa and Latin America.

Our large portfolio of marketed products and deeply integrated treatment and monitoring platform have enabled us to achieve rapid growth. Furthermore, we are currently in the early stage of marketing our patch insulin pump system and CGMS. We expect our business will continue to grow, as we ramp up the sales of our patch insulin pump system and CGMS, and commence the marketing of our closed loop solutions, in particular, our artificial pancreas.

As our product portfolio diversifies, we are making efforts in the design and training of control algorithms for our closed loop solutions. We are also seeking to synthesize advanced analytical tools and artificial intelligence (“AI”) to gain in-depth insights into diabetes management.

We aspire to significantly improve treatment outcomes and ultimately reshape the diabetes monitoring, treatment and management paradigm in China and globally. To achieve such aspiration, we will keep improving the features and quality of our products, developing our R&D capabilities, expanding our global footprint and building a cloud-based diabetes management platform to bring clinical and commercial benefits to diabetes patients all over the world.

OUR CORE PRODUCT

Equil

Our Core Product Equil is a tubeless patch pump worn directly on the body that combines the pumping mechanism and infusion set in a small wearable package. Equil received CE marking in Europe in June 2017 and the marketing approval by the NMPA, for adult use, in China in September 2017. We started to commercialize Equil in China and Europe in 2018. We have submitted a 510(k) premarket notification for Equil to the FDA in February 2021, and we expect to receive the FDA clearance in the first half of 2022.

We are further developing Equil, including:

- *Expansion to Use by Children and Adolescents:* We are preparing for a pivotal multi-center, open-label, randomized, cross-over, noninferiority validation clinical trial to expand the use of Equil to children and adolescents (aged 3 to 18 years old) with diabetes. We are currently in the process of executing the agreements with target hospitals to perform the clinical trials and providing relevant trainings to physicians and nurses. We expect to complete the registrational clinical trial in

SUMMARY

China and submit the registration application to the NMPA in the second half of 2021. We communicated with the NMPA regarding the clinical trial for such indication expansion in July 2020, and then filed the clinical trial record with the local counterpart of the NMPA in the same month.

- *Second-Generation Patch Insulin Pump System:* The second-generation patch insulin pump system will be built on the technology infrastructures of Equil, including the proprietary drive system, sensors, software, algorithm, architecture and accessories. We are currently working on the design of our second-generation patch insulin pump system. We plan to initiate the clinical trial in the first half of 2022. We expect to complete the registrational clinical trial and submit the registration application to the NMPA in the first half of 2023.
- *Artificial Pancreas:* Leveraging our advanced technologies in the development of patch insulin pump system and CGMS, we are currently developing an artificial pancreas. We expect to obtain the trial approval, initiate and complete the clinical trial in 2022 and register in China, the U.S. and the EU in 2023.

For further details, see “Business—Our Products and Product Pipeline—Equil – Core Product.”

OUR SELECTED PRODUCT AND PRODUCT CANDIDATE

AiDEX G7

AiDEX CGMS is designed to gather information about glucose levels every few minutes, allowing the user to see a graph of glucose levels rather than just a single measurement snapshot at a given point in time. AiDEX G7, our first AiDEX CGMS, primarily focuses on the clinical needs of patients with Type 1 diabetes and severe Type 2 diabetes who need to closely monitor their blood glucose levels. AiDEX G7 has been certified by the NMPA in May 2020 to be eligible for the Special Approval Procedures of Innovative Medical Devices promulgated by the NMPA. We commenced the pivotal clinical trial for AiDEX G7 in China in July 2019. We had an online official communication with the NMPA in February 2021, in which the NMPA and our Company mainly discussed about the regulatory pathway of AiDEX G7 and the applicable laws, regulations and guidelines in relation to product registration. The NMPA confirmed that they had no objection if we applied for the marketing approval of AiDEX G7, following the Special Approval Procedures of Innovative Medical Devices promulgated by the NMPA. Following such communications, the NMPA accepted our registration application in the first quarter of 2021. Other than the above, we have not had any material regulatory communications with the NMPA for AiDEX G7.

For further details, see “Business—Our Products and Product Pipeline—AiDEX CGMS.”

SUMMARY

PanCares – Artificial Pancreas

The artificial pancreas is an integrated diabetes management medical device that tracks blood glucose levels using a continuous glucose monitor and automatically delivers the insulin when needed using an insulin pump according to its control algorithm. We have completed a market and feasibility research in the first quarter of 2021, and expect to complete the engineering verification of our artificial pancreas in the first half of 2022. We expect to obtain the trial approval, initiate and complete the clinical trial in 2022 and register in China, the U.S. and the EU in 2023.

For details, see “Business—Our Products and Product Pipeline—PanCares – Artificial Pancreas.”

INTELLECTUAL PROPERTY RIGHTS

As of the Latest Practicable Date, we owned 59 issued patents and pending patent applications. We had 17 issued patents and 26 pending patent applications in China. We also had one issued overseas patent, seven overseas patent applications and eight international patent applications under the Patent Cooperation Treaty (“PCT”). The material issued patents and patent applications of which we are the registered owners primarily directed to the major components, structures, systems and methods of Equil, our Core Product, AiDEX CGMS and our product candidates. These material issued patents are set to expire from 2032 to 2039. See “Business—Intellectual Property Rights.”

During the Track Record Period and up to the Latest Practicable Date, we were not involved in any legal, arbitral or administrative proceedings or claims of infringement of any intellectual property rights, in which we may be a claimant or a respondent. Our Directors confirm that they are not aware of any legal, arbitral or administrative proceedings of infringement of any third parties’ intellectual property rights by us as of the Latest Practicable Date. For additional information with regard to other types of intellectual property and measures to safeguard our intellectual property rights, see “Business—Intellectual Property Rights.” For risks related to intellectual property rights, see “Risk Factors—Risks Relating to Our Intellectual Property Rights.”

OUR COMPETITIVE STRENGTHS

We believe the following strengths have contributed to our success and differentiated us from our competitors.

- Pioneer of reshaping diabetes management paradigm through integrated continuous treatment and monitoring devices in China and globally
- Leading patch insulin pump portfolio with the first and only domestically developed patch insulin pump
- Global leading player in the field of CGMS with top-notch product portfolio

SUMMARY

- Forerunner in designing and developing the artificial pancreas by integrating insulin pump and CGMS with AI-optimized algorithms
- Integrated platform with robust R&D, manufacturing and commercialization capabilities
- Visionary management team of industry veterans and industry-leading investors

OUR STRATEGIES

Our objective in the mid-term is to leverage our strengths in patch insulin pump system and CGMS to continue to grow sales, develop and launch our closed loop solutions, increase our brand awareness and expand our global footprint. In the long term, we aim to build a cloud-based diabetes management platform to bring clinical and commercial benefits to diabetes patients all over the world. To achieve these objectives, we intend to pursue the following strategies.

- Advance diabetes monitoring, treatment and management around the globe with our diversified product portfolio
- Continue to develop our multidisciplinary R&D capabilities and address the evolving clinical demands
- Continue to expand our global footprint through a user-centric and clinical-data driven sales strategy and a diversified commercialization channel
- Continue to increase our manufacturing capacity to support our growth and achieve economies of scale
- Build a cloud-based diabetes management platform to enable the formulation of personalized diabetes solutions and a closed loop diabetes management ecosystem

CUSTOMERS

In line with the industry practice in the medical devices industry, we sell substantially all of our products to distributors, who are our customers, and they resell our products to hospitals, pharmacies or individual customers. For the years ended December 31, 2019 and 2020, all of our five largest customers were distributors and the aggregate sales to our five largest customers were RMB6.8 million and RMB11.2 million, representing 13.2% and 14.9% of our revenue, respectively. Sales to our largest customer for the same periods were RMB1.6 million and RMB3.1 million, representing 3.1% and 4.1% of our revenue, respectively. See “Business—Customers.”

SUMMARY

RAW MATERIALS AND SUPPLIERS

For the production of our diabetes products and product candidates, our principal raw materials are printed circuit boards, wafer parts, motors and LCD panels, and other raw materials include packaging materials and plastic parts.

For the years ended December 31, 2019 and 2020, purchases from our five largest suppliers in aggregate accounted for 33.7% and 19.3% of our total purchases (including value added tax), respectively, and purchases from our largest supplier accounted for 19.4% and 5.8% of our total purchases for the same periods (including value added tax), respectively. See “Business—Raw Materials and Suppliers.”

SUMMARY OF KEY FINANCIAL INFORMATION

The summary historical data of financial information set forth below have been derived from, and should be read in conjunction with, our consolidated financial statements, including the accompanying notes, set forth in the Accountants’ Report set out in Appendix I to this Document, as well as the information set forth in “Financial Information” of this Document.

Summary of Consolidated Statements of Profit or Loss

	For the year ended	
	December 31,	
	2019	2020
	<i>RMB’000</i>	<i>RMB’000</i>
Revenue	51,863	75,277
Cost of sales	(27,780)	(38,733)
Gross profit	24,083	36,544
Other income and gains	8,716	27,663
Selling and distribution expenses ⁽¹⁾	(27,003)	(55,059)
Administrative expenses ⁽¹⁾	(33,615)	(45,758)
Impairment losses on financial assets, net	(423)	(188)
Research and development expenses ⁽¹⁾	(50,060)	(82,009)
Other expenses	(1)	(2,135)
Finance costs	(311)	(308)
Loss before tax	(78,614)	(121,250)
Income tax expense	–	–
Loss for the year	(78,614)	(121,250)

Note:

- (1) We incurred equity-settled share award expenses of RMB57.6 million and RMB111.2 million for the years ended December 31, 2019 and 2020, respectively, which were allocated into selling and distribution expenses, administrative expenses and research and development expenses for the respective years.

SUMMARY

Summary of Consolidated Statements of Financial Position

	As of December 31,	
	2019	2020
	<i>RMB'000</i>	<i>RMB'000</i>
Total non-current assets	69,194	88,998
Total current assets	195,549	688,276
Total assets	264,743	777,274
Total current liabilities	47,953	48,757
Net current assets	147,596	639,519
Total non-current liabilities	–	–
Total liabilities	47,953	48,757
Net assets	216,790	728,517
Share capital	–	360,000
Paid-in capital	74,402	–
Reserves	142,388	368,517
Total equity	216,790	728,517

SUMMARY

Summary of Consolidated Statements of Cash Flows

	For the year ended December 31,	
	2019	2020
	<i>RMB'000</i>	<i>RMB'000</i>
Cash flows from operating activities before changes in working capital	(23,182)	(10,252)
Changes in working capital	4,380	(1,699)
Interest received	848	2,376
Net cash flows used in operating activities	(17,954)	(9,575)
Net cash flows used in investing activities	(95,141)	(1,222)
Net cash flows from financing activities	100,876	511,276
Net increase/(decrease) in cash and cash equivalents	(12,219)	500,479
Cash and cash equivalent at beginning of the year	53,461	41,428
Effect of foreign exchange rate changes	186	(2,107)
Cash and cash equivalents at end of the year	41,428	539,800

Our cash burn rate refers to the average monthly amount of cash operating costs and payments for property, plant and equipment. We had cash and cash equivalents of RMB539.8 million as of December 31, 2020. We estimate that we will receive net [REDACTED] of approximately HK\$[REDACTED] after deducting the [REDACTED] fees and expenses payable by us in the [REDACTED], assuming no [REDACTED] is exercised and assuming an [REDACTED] of HK\$[REDACTED] per [REDACTED], being the mid-point of the indicative [REDACTED] in this Document. Assuming an average cash burn rate going forward of two times the level in 2020, we estimate that our cash and cash equivalents as of December 31, 2020 will be able to maintain our financial viability for approximately 26 months, or if we take into account [REDACTED] of the estimated net [REDACTED] from the [REDACTED] (namely, the portion allocated for our working capital and other general corporate purposes), approximately [REDACTED] months.

SUMMARY

Key Financial Ratios

The following table sets forth our key financial ratios as of the dates indicated.

	As of December 31,	
	2019	2020
Current ratio ⁽¹⁾	4.1	14.1
Gearing ratio ⁽²⁾	4.6%	–
Quick ratio ⁽³⁾	3.9	13.7

Notes:

- (1) Current ratio represents current assets divided by current liabilities as of the same date.
- (2) Gearing ratio equals the total sum of interest-bearing bank borrowings and lease liabilities divided by total equity as of the end of the year.
- (3) Quick ratio represents current assets less inventories and divided by current liabilities as of the same date.

[REDACTED]

SUMMARY

OUR SINGLE LARGEST GROUP OF SHAREHOLDERS

Immediately prior to the [REDACTED], our Company is owned as to 24.52% by Dr. Zheng, 5.29% by Hangzhou Yantai and 4.36% by Hangzhou Hengtai. Hangzhou Yantai and Hangzhou Hengtai are Employee Incentive Platforms, both of which are controlled by Dr. Zheng, being a sole general partner of Hangzhou Yantai and Hangzhou Hengtai. Therefore, Dr. Zheng, directly and through Hangzhou Yantai and Hangzhou Hengtai, controlled approximately 34.17% of our total issued share capital as of the Latest Practicable Date. Therefore, Dr. Zheng, Hangzhou Yantai and Hangzhou Hengtai constitute our Controlling Shareholders (as defined under the Listing Rules) before [REDACTED]. Immediately following the completion of the [REDACTED] and assuming the [REDACTED] is not exercised, Dr. Zheng, Hangzhou Yantai and Hangzhou Hengtai will control approximately [REDACTED]% of our total issued share capital. Therefore, they will not be regarded as our Controlling Shareholders upon [REDACTED], but they will remain as our Single Largest Group of Shareholders upon [REDACTED].

OUR [REDACTED] INVESTORS

Since 2014, we have entered into several rounds of financing agreements with our [REDACTED] Investors. For further details of the identity and background of the [REDACTED] Investors, see “History, Development and Corporate Structure—Detailed Terms of the [REDACTED] Investments—5. Information about our [REDACTED] Investors.”

DIVIDEND

No dividend has been paid or declared by us for the years ended December 31, 2019 and 2020, respectively. You should note that historical dividend distributions are not indicative of our future dividend distribution policy.

After completion of the [REDACTED], our Shareholders will be entitled to receive dividends we declare. As of the Latest Practicable Date, we did not have a formal dividend policy. The Board has approved a dividend policy, which will become effective upon [REDACTED]. Under the dividend policy, we intend to provide our Shareholders with interim or annual dividends as appropriate. The Board is required to consider, among other things, the following factors when proposing dividends and determining the amount of dividends:

- our actual and projected financial performance;
- our estimated working capital requirements, capital expenditure requirements and future business expansion plan;
- our present and future cash flow;

SUMMARY

- other internal and external factors that may have an impact on our business operations or financial performance and position; and
- other factors that our Board of Directors deem relevant.

Any declaration and payment as well as the amount of dividends will be subject to our constitutional documents, including (where required) the approval of our Shareholders.

PRC laws require that dividends be paid only out of our distributable profits. Distributable profits are our after-tax profits, less any recovery of accumulated losses and appropriations to statutory and other reserves that we are required to make. As a result, we may not have sufficient or any distributable profits to make dividend distributions to our Shareholders, even if we become profitable. Any distributable profits not distributed in a given year are retained and available for distribution in subsequent years. Our dividend distribution may also be restricted if we incur debt or losses or in accordance with any restrictive covenants in bank credit facilities, convertible bond instruments or other agreements that we or our subsidiary may enter into in the future.

FUTURE PLANS AND USE OF [REDACTED]

We estimate that we will receive net [REDACTED] of approximately HK\$[REDACTED] after deducting the [REDACTED] fees and expenses payable by us in the [REDACTED], assuming no [REDACTED] is exercised and assuming an [REDACTED] of HK\$[REDACTED] per [REDACTED], being the mid-point of the indicative [REDACTED] of HK\$[REDACTED] to HK\$[REDACTED] per [REDACTED] in this Document. We intend to use the net [REDACTED] we will receive from the [REDACTED] for the following purposes, subject to changes in light of our evolving business needs and changing market conditions:

- [REDACTED]%, or approximately HK\$[REDACTED] allocated to our Core Product as follows:
 - (i) [REDACTED]%, or approximately HK\$[REDACTED], will be used to fund pre-clinical studies to improve the features of our Core Product and its further development. See “Business—Our Products and Product Pipeline—Equil – Core Product—Research and Development Plans.”
 - (ii) [REDACTED]%, or approximately HK\$[REDACTED], will be used to fund ongoing and planned clinical trials of our Core Product for its further development, including but not limited to clinical trials for our Core Product’s indication expansion, to prepare for and carry out registration of our Core Product in major markets worldwide. See “Business—Our Products and Product Pipeline—Equil – Core Product—Research and Development Plans.”

SUMMARY

- (iii) [REDACTED]%, or approximately HK\$[REDACTED], will be used to fund the establishment of our cloud-based diabetes management platform which is expected to provide integrated value-added services to patients and healthcare providers utilizing our Core Product to support the post-marketing operation and feedback collection for further R&D of our Core Product. See “Business—Research and Development—Cloud-based Diabetes Management Platform.”
- (iv) [REDACTED]%, or approximately HK\$[REDACTED], will be used to fund the expansion of our manufacturing capacity of our Core Product, by upgrading our existing production lines and purchasing new machinery. See “Business—Our Strategies—Continue to increase our manufacturing capacity to support our growth and achieve economies of scale.”
- (v) [REDACTED]%, or approximately HK\$[REDACTED], will be used to enhance our commercialization capabilities for our Core Product through expanding our global footprint by recruiting high-caliber sales staff with extensive local experience and establishing long-term cooperation with leading distribution partners, and organizing and participating in academic conferences and activities, among other efforts. See “Business—Our Strategies—Continue to expand our global footprint through a user-centric and clinical-data driven sales strategy and a diversified commercialization channel.”
- [REDACTED]%, or approximately HK\$[REDACTED] allocated to our CGMS as follows:
 - (i) [REDACTED]%, or approximately HK\$[REDACTED], will be used to fund the pre-clinical studies, including but not limited to develop the second generation of our CGMS product, AiDEX X, which is designed for non-intensive diabetics, pre-diabetics, and health-aware non-diabetic users. See “Business—Our Products and Product Pipeline—AiDEX CGMS—Research and Development Plans.”
 - (ii) [REDACTED]%, or approximately HK\$[REDACTED], will be used to fund clinical trials of our AiDEX G7, including but not limited to clinical trials for its indication expansion to use by children and adolescents and clinical trials for the development of our AiDEX X, to prepare for and carry out its registration in major markets worldwide. See “Business—Our Products and Product Pipeline—AiDEX CGMS—Research and Development Plans.”
 - (iii) [REDACTED]%, or approximately HK\$[REDACTED], will be used to fund the expansion of our manufacturing capacity of our CGMS, by upgrading our existing production lines and purchasing new machinery. See “Business—Our Strategies—Continue to increase our manufacturing capacity to support our growth and achieve economies of scale.”

SUMMARY

- (iv) [REDACTED]%, or approximately HK\$[REDACTED], will be used to enhance our commercialization capabilities for our CGMS through expanding our global footprint by recruiting high-caliber sales staff with extensive local experience and establishing long-term cooperation with leading distribution partners, and organizing and participating in academic conferences and activities, among other efforts. See “Business—Our Strategies—Continue to expand our global footprint through a user-centric and clinical-data-driven sales strategy and a diversified commercialization channel.”
- [REDACTED]%, or approximately HK\$[REDACTED] allocated to the pre-clinical studies, clinical trials, registration, manufacturing and commercialization of our other products and product candidates.
 - [REDACTED]%, or approximately HK\$[REDACTED], allocated for working capital and other general corporate purposes.

For further details, see “Future Plans and Use of [REDACTED].”

RISK FACTORS

We believe that there are certain risks involved in our operations, many of which are beyond our control. These risks are set out in “Risk Factors” in this Document. Some of the major risks we face include:

- We have incurred net losses since our inception and may incur net losses for the foreseeable future, and you may lose substantially all your [REDACTED] in us given the high risks involved in the medical device business.
- Our revenue growth was mainly driven by the sales growth of Equil. Failure to achieve the anticipated sales growth of Equil may have a material adverse impact on our business and results of operations.
- Our future growth depends substantially on the success of our product candidates. If we are unable to successfully complete clinical development, obtain regulatory approval and commercialize our product candidates, or experience significant delays in doing so, our business will be materially harmed.
- If we encounter difficulties enrolling patients in our clinical trials, our clinical development activities could be delayed or otherwise adversely affected.
- Clinical product development involves a lengthy and expensive process with an uncertain outcome, and unsuccessful clinical trials or procedures relating to products under development could have a material adverse effect on our prospects.

SUMMARY

- All material aspects of the research, development and commercialization of our products are heavily regulated.
- If we are not able to obtain, or experience delays in obtaining, required regulatory approvals, we will not be able to commercialize our product candidates, and our ability to generate revenue will be materially impaired.
- Undesirable adverse events caused by our products and product candidates could interrupt, delay or halt clinical trials, delay or prevent regulatory approval, limit the commercial profile of an approved label, or result in significant negative consequences following any regulatory approval.
- We have relatively limited experience in marketing and sales of our products and the commercialization of new products may require additional resources.
- If we fail to manage our distributors effectively, or fail to maintain, expand and optimize an effective distribution channel for our products, our business and sales of the relevant products could be adversely affected.

[REDACTED] EXPENSES

Our [REDACTED] expenses mainly include professional fees paid and payable to the professional parties, and [REDACTED] payable to the [REDACTED], for their services rendered in relation to the [REDACTED] and the [REDACTED]. The estimated total [REDACTED] expenses (based on the mid-point of the indicative [REDACTED] and assuming that the [REDACTED] is not exercised) are approximately HK\$[REDACTED], of which approximately HK\$[REDACTED] is expected to be charged to our consolidated statements of comprehensive income and the remaining amount of HK\$[REDACTED] is expected to be recognized directly as a deduction from equity upon the [REDACTED]. The [REDACTED] expenses above are the latest practicable estimate for reference only, and the actual amount may differ from this estimate.

RECENT DEVELOPMENT AND NO MATERIAL ADVERSE CHANGE

Impact of COVID-19 Outbreak

Since December 2019, a novel strain of coronavirus or COVID-19, has become widespread in China and around the world. In March 2020, the World Health Organization declared the COVID-19 a pandemic, given its threat beyond a public health emergency of international concern that the organization had declared in January 2020. To contain the virus’ spread, China and many other countries have taken various restrictive measures, such as lockdowns, quarantines, closure of work places, travel restrictions and home office policies.

SUMMARY

In response to the COVID-19 pandemic, hospitals and physicians across China focused their efforts on treating COVID-19 patients and prioritized resources toward containing the virus, resulting in the completion of certain clinical trial being delayed. Nonetheless, the COVID-19 pandemic has not caused any early termination of our clinical trials or necessitated removal of any patients enrolled in our clinical trials. We have not experienced and currently do not expect any material disruptions in regulatory affairs with respect to our overall development plans due to the COVID-19 pandemic.

During the COVID-19 outbreak, reduced transportations and social distancing policies have affected the organization of conferences, seminars and other offline sales and marketing activities, in particular, interactions with overseas clients. As a result, the demand for our products in China and overseas decreased, which adversely affected our financial performance in the first quarter of 2020. With COVID-19 pandemic gradually stabilized in China, our business started to recover and gradually resumed growth since the second quarter of 2020. As of the Latest Practicable Date, the COVID-19 pandemic had not been contained in Europe and thus our access to local markets and sales and marketing activities there were limited, which negatively impacted our market expansion and sales growth. We have mobilized internal and external resources and leveraged our strong operating capabilities to minimize the adverse effect on our business caused by the COVID-19 outbreak. We had not experienced any material disruption or shortage of supplies since the COVID-19 outbreak, and our suppliers had resumed normal operations as of the Latest Practicable Date.

Following the COVID-19 outbreak, to prevent any spread of COVID-19 in our offices and production facilities, we have implemented preventive measures such as regularly sterilizing and ventilating our offices and production facilities, checking the body temperature of our employees daily, keeping track of the travel history and health conditions of employees, and providing face masks and disinfectant to employees attending our offices and facilities. We also adopted various measures, such as cooperating with clinical trial sites to offer personal protection equipment such as masks to our enrolled patients, engaging in frequent communications with our principal investigators to identify and address any issues that may arise, suggesting the investigators to communicate with the enrolled patients on visiting local qualified hospitals for follow-up evaluations if necessary. As of the Latest Practicable Date, we were not aware of any suspected or confirmed active COVID-19 cases on our premises, among our employees or enrolled patients.

The extent to which the COVID-19 outbreak impacts our business, results of operations and financial condition will depend on many factors beyond our control, including the extent of resurgences of the disease and its variants, vaccine distribution and other actions in response to the virus or to contain its impact. It is uncertain when and whether COVID-19 could be contained globally. We are closely monitoring impact of COVID-19 outbreak on us and plan to continue implementing measures necessary to ease the impact of the outbreak on our operations. However, we cannot assure you that the COVID-19 pandemic will not further escalate or have a material adverse effect on our results of operations, financial condition or prospects. Our operations may also be adversely affected if any of our employees or employees of our distributors, suppliers and other business partners were suspected of contracting or

SUMMARY

contracted COVID-19. In addition, the commencement of new clinical trials for product candidates in our development pipeline could also be delayed or prevented by any delay or failure in subject recruitment or enrollment. For more details, see “Risk Factors—Our operations and business plans may be adversely affected by natural disasters, health epidemics and pandemics, civil and social disruption and other outbreaks, in particular the COVID-19 outbreak.”

No Material Adverse Change

Our Directors confirm that up to the date of this Document, there has been no material adverse change in our financial, operational or trading positions or prospects since December 31, 2020, being the end of the period reported on as set out in the Accountants’ Report included in Appendix I to this Document.

DEFINITIONS

In this Document, unless the context otherwise requires, the following terms and expressions have the meanings set forth below. Certain other terms are explained in the section headed “Glossary of Technical Terms” in this Document.

“affiliate”	with respect to any specified person, any other person, directly or indirectly, controlling or controlled by or under direct or indirect common control with such specified person
“Articles of Association” or “Articles”	the articles of association of our Company, as amended, which shall become effective on the [REDACTED], a summary of which is set out in Appendix V in this Document
“associate(s)”	has the meaning ascribed thereto under the Listing Rules
“Audit Committee”	the audit committee of the Board
“Board” or “Board of Directors”	the board of Directors of our Company
“Business Day”	a day on which banks in Hong Kong are generally open for normal business to the public and which is not a Saturday, Sunday or public holiday in Hong Kong
“CAGR”	compound annual growth rate
“CCASS”	the Central Clearing and Settlement System established and operated by HKSCC
“CCASS Clearing Participant”	a person admitted to participate in CCASS as a direct clearing participant or general clearing participant
“CCASS Custodian Participant”	a person admitted to participate in CCASS as a custodian participant

DEFINITIONS

[REDACTED]

“CCASS Investor Participant”	a person admitted to participate in CCASS as an investor participant who may be an individual or joint individuals or a corporation
“CCASS Operational Procedures”	the Operational Procedures of HKSCC in relation to CCASS, containing the practices, procedures and administrative requirements relating to operations and functions of CCASS, as from time to time in force
“CCASS Participant”	a CCASS Clearing Participant, a CCASS Custodian Participant or a CCASS Investor Participant
“Chief Executive Officer”	the chief executive officer of our Company
“China” or “PRC”	the People’s Republic of China excluding, for the purpose of this Document, Hong Kong, the Macau Special Administrative Region of the PRC and Taiwan
“CIC”	China Insights Industry Consultancy Limited, an independent professional market research and consulting company
“close associate(s)”	has the meaning ascribed thereto under the Listing Rules

DEFINITIONS

“Companies (Winding Up and Miscellaneous Provisions) Ordinance”	the Companies (Winding Up and Miscellaneous Provisions) Ordinance (Chapter 32 of the Laws of Hong Kong), as amended, supplemented or otherwise modified from time to time
“Companies Ordinance”	the Companies Ordinance (Chapter 622 of the Laws of Hong Kong) as amended, supplemented or otherwise modified from time to time
“Company”, “our Company” or “the Company”	MicroTech Medical (Hangzhou) Co., Ltd.* (微泰醫療器械(杭州)股份有限公司), a limited liability company incorporated in the PRC on January 20, 2011 and converted into a joint stock limited liability company incorporated in the PRC on November 6, 2020, whose predecessor was MicroTech Medical (Hangzhou) Company Limited (微泰醫療器械(杭州)有限公司)
“connected person(s)”	has the meaning ascribed thereto under the Listing Rules
“connected transaction(s)”	has the meaning ascribed thereto under the Listing Rules
“Controlling Shareholder(s)”	has the meaning ascribed thereto under the Listing Rules
“Core Product”	Equil Patch Insulin Pump System, the designated “core product” as defined under Chapter 18A of the Listing Rules
“Corporate Governance Code”	the Corporate Governance Code set out in Appendix 14 to the Listing Rules
“CSDCC”	China Securities Depository and Clearing Corporation* Limited (中國證券登記結算有限責任公司)
“CSRC”	the China Securities Regulatory Commission (中國證券監督管理委員會)
“Director(s)” or “our Director(s)”	the director(s) of our Company
“Domestic Share(s)”	ordinary share(s) issued by our Company, with a nominal value of RMB1.0 each, which are subscribed for or credited as paid in Renminbi

DEFINITIONS

“Dr. Zheng”	Dr. Zheng Pan (鄭攀), the chairman of the Board, an executive Director, the Chief Executive Officer of the Company and a member of the Single Largest Group of Shareholders
“EIT”	enterprise income tax
“EIT Law”	Enterprise Income Tax Law of the PRC (中華人民共和國企業所得稅法)
“EMA”	the European Medicine Agency
“Employee Incentive Schemes”	the employee incentive schemes of our Company approved and adopted by our Board, a summary of the principal terms of which is set forth in “Appendix VI—Statutory and General Information—Further information about our Directors, supervisors, senior management and substantial shareholders—5. Employee Incentive Schemes”
“Employment Incentive Platforms”	Hangzhou Yantai and Hangzhou Hengtai
“Exchange Participant”	a person (a) who, in accordance with the Rules of the Hong Kong Stock Exchange, may trade on or through the Hong Kong Stock Exchange; and (b) whose name is entered in a list, register or roll kept by the Hong Kong Stock Exchange as a person who may trade on or through the Hong Kong Stock Exchange
“Extreme Conditions”	extreme conditions caused by a super typhoon as announced by the government of Hong Kong

[REDACTED]

“Group,” “our Group,” “we” or “us”	our Company and our subsidiary
------------------------------------	--------------------------------

DEFINITIONS

“H Share(s)” overseas listed foreign share(s) in the share capital of our Company with a nominal value of RMB1.0 each, which is/are to be subscribed for and traded in HK dollars and to be [REDACTED] on the Hong Kong Stock Exchange

[REDACTED]

“Hangzhou Hengtai” Hangzhou Hengtai Brand Management Partnership (Limited Partnership) (杭州衡泰品牌管理合夥企業(有限合夥)), a limited partnership established in the PRC on December 11, 2019, of which Dr. Zheng is the sole general partner, one of the Employee Incentive Platforms

“Hangzhou Yantai” Hangzhou Yantai Investment Partnership (Limited Partnership) (杭州研泰投資合夥企業(有限合夥)), a limited partnership established in the PRC on January 2, 2018, of which Dr. Zheng is the sole general partner, one of the Employee Incentive Platforms

[REDACTED]

“HKFRS” Hong Kong Financial Reporting Standards

“HKSCC” Hong Kong Securities Clearing Company Limited, a wholly- owned subsidiary of Hong Kong Exchanges and Clearing Limited

“HKSCC Nominees” HKSCC Nominees Limited, a wholly-owned subsidiary of HKSCC

“Hong Kong” or “HK” the Hong Kong Special Administrative Region of the PRC

DEFINITIONS

[REDACTED]

“Hong Kong Stock Exchange” or “Stock Exchange” The Stock Exchange of Hong Kong Limited, a wholly-owned subsidiary of Hong Kong Exchanges and Clearing Limited

[REDACTED]

“Independent Third Party(ies)” any entity(ies) or person(s) who is not a connected person of our Company within the meaning of the Hong Kong Listing Rules

[REDACTED]

DEFINITIONS

[REDACTED]

“Joint Sponsors”

Goldman Sachs (Asia) L.L.C. and China International Capital Corporation Hong Kong Securities Limited

“Latest Practicable Date”

May 5, 2021 being the latest practicable date for the purpose of ascertaining certain information contained in this Document prior to its publication

DEFINITIONS

[REDACTED]

“Listing Committee” the Listing Committee of the Hong Kong Stock Exchange

[REDACTED]

“Listing Rules” or “Hong Kong Listing Rules” the Rules Governing the Listing of Securities on the Hong Kong Stock Exchange, as amended, supplemented or otherwise modified from time to time

“Main Board” the stock exchange (excluding the option market) operated by the Hong Kong Stock Exchange which is independent from and operated in parallel with Growth Enterprise Market of the Hong Kong Stock Exchange

“Mandatory Provisions” the Mandatory Provisions for Articles of Association of Companies to be Listed Overseas (到境外上市公司章程必備條款), as amended, supplemented or otherwise modified from time to time, for inclusion in the articles of association of companies incorporated in the PRC to be listed overseas (including Hong Kong), which were promulgated by the former Securities Commission of the State Council and the former State Commission for Restructuring the Economic Systems on September 29, 1994

“MicroTech E-Commerce” Hangzhou MicroTech E-Commerce Co., Ltd. (杭州微泰電子商務有限公司), a limited liability company established under the laws of the PRC on September 19, 2019 and our Company’s subsidiary

“MicroTech Medical” MicroTech Medical (Hangzhou) Company Limited (微泰醫療器械(杭州)有限公司), the predecessor of our Company established under the laws of the PRC on January 20, 2011

“Ministry of Finance” or “MOF” the Ministry of Finance of the PRC (中華人民共和國財政部)

DEFINITIONS

“MOFCOM”	the Ministry of Commerce of the PRC (中華人民共和國商務部)
“NDRC”	the National Development and Reform Commission of the PRC* (中華人民共和國國家發展和改革委員會)
“NMPA”	National Medical Products Administration (國家藥品監督管理局) and its predecessor, the China Food and Drug Administration (國家食品藥品監督管理總局)
“Nomination Committee”	the nomination committee of the Board

[REDACTED]

“PBOC”	the People’s Bank of China (中國人民銀行), the central bank of the PRC
--------	--

DEFINITIONS

“PRC Company Law”	the Company Law of the People’s Republic of China (中華人民共和國公司法)
“PRC GAAP”	generally accepted accounting principles in the PRC
“PRC Government” or “State”	the central government of the PRC, including all governmental subdivisions (including principal, municipal and other regional or local government entities) and instrumentalities
“PRC Legal Advisor”	Llinks Law Offices, our legal advisor as to PRC laws
“[REDACTED] Investment(s)”	the investment(s) in our Company undertaken by the [REDACTED] Investors pursuant to the respective equity transfer agreement(s) and capital increase agreement(s), details of which are set out in the section headed “History, Development and Corporate Structure” in this Document
“[REDACTED] Investor(s)”	the investor(s) from whom our Company obtained several rounds of investments, details of which are set out in the section headed “History, Development and Corporate Structure” in this Document

[REDACTED]

“Province”	each being a province or, where the context requires, a provincial-level autonomous region or municipality under the direct supervision of the central government of the PRC
------------	--

DEFINITIONS

“Qualified Institutional Buyer” or “QIB”	a qualified institutional buyer within the meaning of Rule 144A under the U.S. Securities Act
“Regulation S”	Regulation S under the U.S. Securities Act
“Remuneration and Assessment Committee”	the remuneration and assessment committee of the Board
“RMB” or “Renminbi”	Renminbi, the lawful currency of the PRC
“Rule 144A”	Rule 144A under the U.S. Securities Act
“SAFE”	the State Administration of Foreign Exchange of the PRC (中國國家外匯管理局)
“SAT”	the State Administration of Taxation of the PRC (國家稅務總局)
“Securities and Futures Ordinance” or “SFO”	the Securities and Futures Ordinance (Chapter 571 of the Laws of Hong Kong), as amended, supplemented or otherwise modified from time to time
“SFC”	the Securities and Futures Commission of Hong Kong
“Shanghai-Hong Kong Stock Connect”	a securities trading and clearing links program developed by the Hong Kong Stock Exchange, Shanghai Stock Exchange, HKSCC and CSDCC for the establishment of mutual market access between Hong Kong and Shanghai, including Southbound Trading and Northbound Trading
“Share(s)”	ordinary share(s) in the capital of our Company with a nominal value of RMB1.0 each
“Shareholder(s)”	holder(s) of the Share(s)
“Shenzhen-Hong Kong Stock Connect”	a securities trading and clearing links program to be developed by the Hong Kong Stock Exchange, Shenzhen Stock Exchange, HKSCC and CSDCC for the establishment of mutual market access between Hong Kong and Shenzhen
“Single Largest Group of Shareholders”	refers to Dr. Zheng, Hangzhou Yantai and Hangzhou Hengtai. See “Relationship with our Single Largest Group of Shareholders”

DEFINITIONS

“Sophisticated Investors”	has the meaning ascribed to it under Guidance Letter HKEXGL92-18 issued by the Stock Exchange, and unless the context otherwise requires, refers to QM32 Limited, QM153 Limited, Shanghai Li’an Venture Capital Center (Limited Partnership) (上海禮安創業投資中心(有限合夥)), Suzhou Likang Equity Investment Center (Limited Partnership) (蘇州禮康股權投資中心(有限合夥)) and Jiangsu Jiequan Lize Health Industry Venture Capital Fund (Limited Partnership) (江蘇逮泉醴澤健康產業創業投資基金(有限合夥))
“Special Regulations”	the Special Regulations of the State Council on the Overseas Offering and Listing of Shares by Joint Stock Limited Companies (國務院關於股份有限公司境外募集股份及上市的特別規定), promulgated by the State Council on August 4, 1994
	[REDACTED]
“State Council”	the State Council of the PRC (中華人民共和國國務院)
“Strategy Committee”	the strategy committee of the Board
“subsidiary(ies)”	has the meaning ascribed thereto under the Listing Rules
“substantial shareholder(s)”	has the meaning ascribed thereto under the Listing Rules
“Supervisor(s)”	member(s) of our Supervisory Committee
“Supervisory Committee”	the supervisory committee of our Company
“Takeovers Code”	the Codes on Takeovers and Mergers and Share Buy-back issued by the SFC, as amended, supplemented or otherwise modified from time to time
“Track Record Period”	the periods comprising the two financial years ended December 31, 2019 and 2020

[REDACTED]

DEFINITIONS

“Unlisted Foreign Share(s)”	ordinary share(s) issued by our Company, with a nominal value of RMB1.0 each, which is/are subscribed for or credited as paid in a currency other than Renminbi, held by foreign investors and not listed on any stock exchange
“U.S.” or “United States”	the United States of America, its territories, its possessions and all areas subject to its jurisdiction
“U.S. dollar”, “US\$” or “USD”	United States dollar, the lawful currency of the United States
“U.S. FDA” or “FDA”	U.S. Food and Drug Administration
“U.S. Securities Act”	the United States Securities Act of 1933, as amended and supplemented or otherwise modified from time to time, and the rules and regulations promulgated thereunder

For ease of reference, the names of Chinese laws and regulations, governmental authorities, institutions, natural persons or other entities (including our subsidiary) have been included in this Document in both the Chinese and English languages and in the event of any inconsistency, the Chinese versions shall prevail.

* *For identification purposes only*

GLOSSARY OF TECHNICAL TERMS

This glossary contains explanations of certain technical terms used in this Document in connection with our Company and its business. Such terminology and meanings may not correspond to standard industry meanings or usages of those terms.

“acetaminophen”	a non-opioid analgesic and antipyretic agent used to treat pain and fever
“artificial pancreas”	an integrated diabetes management system that tracks blood glucose levels using a continuous glucose monitor and automatically delivers the insulin when needed using an insulin pump according to its control algorithm
“ascorbic acid”	a potent reducing and antioxidant agent that functions in fighting bacterial infections, in detoxifying reactions, and in the formation of collagen in fibrous tissue, teeth, bones, connective tissue, skin, and capillaries
“basal insulin”	a small, continuous infusion of background insulin delivered automatically at a programmed rate, all day and night
“BG Port”	blood glucose strip port, the port that accepts and electrically connects a disposable blood glucose strip to the electronics
“BGMS”	blood glucose monitoring system
“BLE”	bluetooth low energy
“blood glucose”	blood glucose, also referred to as blood sugar, is the amount of glucose in your blood, an indicator of diabetes monitoring
“bolus insulin”	insulin that is taken to lower abnormally high blood glucose levels, typically used to control blood glucose levels following a meal or to counteract an unpredicted high blood glucose level
“calibration-free”	also known as “factory-calibrated”, the ability to use the sensor without the need for BGMS calibration; while users may opt to calibrate at his/her own discretion, a calibration-free CGMS does not require the user to perform a finger stick blood glucose calibration before displaying the glucose values

GLOSSARY OF TECHNICAL TERMS

“cannula”	tiny plastic tube that is usually placed under the skin for insulin delivery
“CE marking”	a certification marking that indicates conformity with health, safety, and environmental protection standards for products sold within the European Economic Area
“CGMS”	continuous glucose monitoring system
“cloud”	the computers and connections that support cloud computing
“CRO”	contract research organization, a company that provides support to the pharmaceutical, biotechnology, and medical device industries in the form of research services outsourced on a contract basis
“CSII therapy”	continuous subcutaneous insulin infusion therapy
“diabetes”	a chronic disease that occurs either when the pancreas does not produce enough insulin or when the body cannot effectively use the insulin it produces
“diabetes management medical devices”	diabetes treatment and monitoring devices
“EU5”	the United Kingdom, Germany, France, Italy and Spain
“FAS”	full analysis set
“GCP”	good clinical practice, an international ethical and scientific quality standard for the performance of a clinical trial on medicinal products involving humans
“gestational diabetes”	a type of diabetes that consists of high blood glucose during pregnancy and is associated with complications for both the mother and child
“glucose sensor electrode”	the particular electrode located on the continuous glucose monitoring sensor that is used to measure the presence of glucose in the interstitial fluid
“glycemic”	pertaining to or suffering from glycemia (i.e., level of sugar (glucose) in the blood)

GLOSSARY OF TECHNICAL TERMS

“GMP”	good manufacturing practices, the aspect of quality assurance that ensures that medicinal products are consistently produced and controlled to the quality standards appropriate to their intended use and as required by the product specification
“HbA1C”	hemoglobin A1C, one of the indicators in the monitoring and management of diabetes
“hematocrit” or “HCT”	a blood test that measures how much of a person’s blood is made up of red blood cells
“hs CRP+CRP”	high-sensitivity C-reactive protein test, also known as full-range CRP test; regular CRP test measures general levels of inflammation in your body, while high sensitivity CRP test detects presences of low levels blood CRP which is usually associated with certain heart conditions
“hypo/hyper-glycaemia”, “hyperglycemia” or “hypoglycemia”	incidence of high/low blood glucose levels
“IDF”	the International Diabetes Federation
“insulin”	a hormone made by the pancreas that helps cells in the body take up glucose (sugar) from the blood to use for energy, which lowers blood glucose levels
“insulin reservoir”	insulin container on the insulin pump and tiny internal tube, which is inserted under the skin that comprises the insulin path from storage to human body
“interstitial proteins”	proteins found within the interstitial fluid
“IVD”	in vitro diagnostic medical devices
“ketone”	a substance with the carbonyl group linking two carbon atoms
“KOL”	key opinion leaders
“LCD”	liquid-crystal display, a flat-panel display or other electronically modulated optical device that uses the light-modulating properties of liquid crystals combined with polarizers

GLOSSARY OF TECHNICAL TERMS

“LED”	light-emitting diode, a semiconductor diode that emits light when conducting current and is used in electronic displays
“MARD”	mean absolute relative difference
“MAU”	one of the indicators in the monitoring and management of diabetes
“MCU”	main control unit, usually a microcontroller or microprocessor
“MDD”	manufacturing medical devices
“MDI”	multiple daily injection
“Minimum step size”	the minimum amount of insulin the pump can deliver; all bolus and basal infusions are multiples of the minimum step size
“MITTP”	modified intent-to-treat population
“non-diabetic”	not related to or affected with diabetes
“non-intensive diabetics”	diabetes patients with no need of intensive diabetes therapy
“NUT”	the threaded element at the end of the pump drive system (gearbox) that interfaces with and pushes the reservoir plunger, which causes infusion
“OCC”	occlusion sensor, which is used to detect infusion blockages
“pancreas”	an organ in the body that secretes several hormones, including insulin and glucagon, as well as digestive enzymes that help break down food
“PDA”	portable diabetes assistant, which is used as a remote control to display data and send data
“pivotal trial”	a randomized, controlled clinical trial of a product designed to demonstrate statistically significant clinical efficacy and safety in human patients (in conjunction with performance of a therapeutic procedure) for regulatory approval of such product

GLOSSARY OF TECHNICAL TERMS

“PM Module”	power management module, which manages battery charging, discharging and external direct current power
“POCT”	point-of-care-testing
“PPP”	per-protocol population
“PPS”	per-protocol set
“RF”	radio frequency circuit that enables the BLE communication
“SMO”	site management organization, an organization that provides clinical trial related services to medical device companies having adequate infrastructure and staff to meet the requirements of the clinical trial protocol
“SS”	safety set
“subcutaneous interstitial fluid”	fluid found in the spaces around cells
“Type 1 diabetes”	a type of diabetes that can develop at any age but occurs most frequently in children and adolescents. When one has Type 1 diabetes, his/her body produces very little or no insulin
“Type 2 diabetes”	a type of diabetes more commonly found in adults and accounts for around 90% of all diabetes cases. When one has Type 2 diabetes, his/her body does not make good use of the insulin that it produces
“uric acid”	a product of the metabolic breakdown of purine nucleotides, and it is a normal component of urine

FORWARD-LOOKING STATEMENTS

We have included in this Document forward-looking statements. Statements that are not historical facts, including but not limited to statements about our intentions, beliefs, expectations or predictions for the future, are forward-looking statements.

This Document contains forward-looking statements and information relating to us and our subsidiary that are based on the beliefs of our management as well as assumptions made by and information currently available to our management. When used in this Document, the words "aim," "anticipate," "believe," "could," "expect," "going forward," "intend," "may," "ought to," "plan," "project," "seek," "should," "will," "would," "vision," "aspire," "target," "schedules," and the negative of these words and other similar expressions, as they relate to us or our management, are intended to identify forward-looking statements. Such statements reflect the current views of our management with respect to future events, operations, liquidity and capital resources, some of which may not materialize or may change. These statements are subject to certain risks, uncertainties and assumptions, including the risk factors as described in this Document, some of which are beyond our control and may cause our actual results, performance or achievements, or industry results, to be materially different from any future results, performance or achievements expressed or implied by the forward-looking statements. You are strongly cautioned that reliance on any forward-looking statements involves known and unknown risks and uncertainties. The risks and uncertainties facing us which could affect the accuracy of forward-looking statements include, but are not limited to, the following:

- our operations and business prospects;
- our ability to maintain relationship with, and the actions and developments affecting, our major customers and suppliers;
- future developments, trends and conditions in the industries and markets in which we operate or plan to operate;
- general economic, political and business conditions in the markets in which we operate;
- changes to the regulatory environment in the industries and markets in which we operate;
- the effects of the on-going COVID-19 pandemic;
- our ability to maintain the market leading positions;
- the actions and developments of our competitors;
- our ability to effectively contain costs and optimize pricing;
- the ability of third parties to perform in accordance with contractual terms and specifications;

FORWARD-LOOKING STATEMENTS

- our ability to retain senior management and key personnel and recruit qualified staff;
- our business strategies and plans to achieve these strategies;
- our ability to defend our intellectual rights and protect confidentiality;
- the effectiveness of our quality control systems;
- change or volatility in interest rates, foreign exchange rates, equity prices, trading volumes, commodity prices and overall market trends, including those pertaining to the PRC and the industry and markets in which we operate; and
- capital market developments.

By their nature, certain disclosures relating to these and other risks are only estimates and should one or more of these uncertainties or risks, among others, materialize, actual results may vary materially from those estimated, anticipated or projected, as well as from historical results. Specifically but without limitation, sales could decrease, costs could increase, capital costs could increase, capital investment could be delayed and anticipated improvements in performance might not be fully realized.

Subject to the requirements of applicable laws, rules and regulations, we do not have any and undertake no obligation to update or otherwise revise the forward-looking statements in this Document, whether as a result of new information, future events or otherwise. As a result of these and other risks, uncertainties and assumptions, the forward-looking events and circumstances discussed in this Document might not occur in the way we expect or at all. Accordingly, you should not place undue reliance on any forward-looking information. All forward-looking statements in this Document are qualified by reference to the cautionary statements in this section as well as the risks and uncertainties discussed in the section headed “Risk Factors” in this Document.

In this Document, statements of or references to our intentions or those of our Directors are made as of the date of this Document. Any such information may change in light of future developments.

RISK FACTORS

An [REDACTED] in our Shares involves significant risks. You should carefully consider all of the information in this Document, including the risks and uncertainties described below, as well as our financial statements and the related notes, and the “Financial Information” section, before deciding to [REDACTED] in our Shares. Particularly, we are a biotechnology company seeking to [REDACTED] on the Main Board of the Stock Exchange under Chapter 18A of the Listing Rules. Our operations and the biotech industry involve certain risks and uncertainties, some of which are beyond our control and may cause you to lose all your [REDACTED] in our Shares. The following is a description of what we consider to be our material risks. Any of the following risks could have a material adverse effect on our business, financial condition, results of operations and growth prospects. In any such an event, the market price of our H Shares could decline, and you may lose all or part of your [REDACTED]. Additional risks and uncertainties not presently known to us or that we currently deem immaterial also may impair our business operations.

These factors are contingencies that may or may not occur, and we are not in a position to express a view on the likelihood of any such contingency occurring. The information given is as of the Latest Practicable Date unless otherwise stated, will not be updated after the date hereof, and is subject to the cautionary statements in the section headed “Forward Looking Statements” in this Document.

RISKS RELATING TO OUR BUSINESS

Risks Relating to the Development of Our Product Candidates

We have incurred net losses since our inception and may incur net losses for the foreseeable future, and you may lose substantially all your [REDACTED] in us given the high risks involved in the medical device business.

Investment in medical device development is highly speculative. It entails substantial upfront capital expenditures and significant risk that a product candidate will fail to gain regulatory approval or become commercially viable. We continue to incur significant expenses related to our ongoing operations. As a result, we incurred losses during the Track Record Period. We incurred net losses of RMB78.6 million and RMB121.3 million for the years ended December 31, 2019 and 2020, respectively. Our operating losses were primarily attributable to the equity-settled share award expenses incurred to incentivize our employees, and costs incurred in connection with our R&D programs, sales and marketing, and general administration. For the years ended December 31, 2019 and 2020, we had equity-settled share award expense of RMB57.6 million and RMB111.2 million, respectively.

We may continue to incur losses for the foreseeable future, and the losses may increase as we expand our development of, and seek regulatory approvals for, our product candidates, and commercialize our products. Typically, it takes many years to develop one new product from the time it is designed to when it is available for commercial sales. In addition, we will

RISK FACTORS

start incurring costs associated with being a [REDACTED] company in Hong Kong after the [REDACTED]. We will also incur costs in support of our growth. The size of our future net losses will depend, in part, on the number and scope of our product development programs and the associated costs of those programs, the cost of commercializing any approved products, our ability to generate revenues and the timing and amount of milestones and other payments we make or receive with arrangements with third parties. If any of our product candidates fails in clinical trials or does not gain regulatory approval, or if approved, fails to achieve market acceptance, we may never become profitable. Even if we achieve profitability in the future, we may not be able to sustain profitability in subsequent periods. Our failure to become and remain profitable would decrease the value of our Company and could impair our ability to raise capital, maintain our R&D efforts, expand our business or continue our operations.

Our revenue growth was mainly driven by the sales growth of Equil. Failure to achieve the anticipated sales growth of Equil may have a material adverse impact on our business and results of operations.

During the Track Record Period, our revenue growth was mainly driven by the sales growth of Equil, our Core Product. Equil is the second commercialized semi-disposable patch insulin pump globally, and the first and only domestically developed patch insulin pump system approved in China and the EU. Following the launch of Equil in 2018, we have seen a rapid revenue growth. We expect that sales of Equil will continue to be a significant driving factor of our revenue growth in the near future.

However, we cannot assure you that demand for Equil will continue to grow as anticipated. There is also no assurance that we will be able to maintain our sales and profit margin for Equil, which may be adversely affected by many factors outside of our control, including downward pricing pressure caused by changes in market competition, expiration of patent protection, introduction of substitute products marketed by our competitors, disruptions in manufacturing or sales, issues with respect to product quality or severe adverse events incurred after the procedure, coverage of medical insurance and disputes over intellectual property or other matters with third parties. If we are unable to maintain the sales growth of Equil, our business, financial condition and results of operations may be materially and adversely affected. Moreover, there is no guarantee that we may be able to develop or acquire new products that would diversify our product portfolio and reduce our dependence on Equil, or to do so in a timely or competitive manner.

RISK FACTORS

Our future growth depends substantially on the success of our product candidates. If we are unable to successfully complete clinical development, obtain regulatory approval and commercialize our product candidates, or experience significant delays in doing so, our business will be materially harmed.

Our business substantially depends on the successful development, regulatory approval and commercialization of our product candidates for the monitoring, treatment and management of diabetes and other product candidates we may innovate and develop in the future. We have invested a significant portion of our efforts and financial resources in the development of our existing product candidates. We incurred net losses in 2019 and 2020, because the expenses we incurred exceeded the gross profit generated from the sales of our current products. Whether we can generate profit from our operating activities largely depends on the successful registration and commercialization of our product candidates. For example, we completed a clinical trial for AiDEX G7, a CGMS product, in China in May 2020 and the NMPA accepted our registration application in the first quarter of 2021. In addition, our artificial pancreas, second-generation patch insulin pump system and AiDEX X are still in their early stage of development.

The success of our product candidates will depend on several factors, including but not limited to:

- completion of preclinical studies, as well as successful enrollment in, and completion of, clinical trials;
- favorable safety and efficacy data from our clinical trials and other studies;
- receipt of regulatory approvals;
- establishing commercial manufacturing capabilities, either by building facilities ourselves or making arrangements with third-party manufacturers;
- the performance by any third parties we may retain in a manner that complies with our protocols and applicable laws and that protects the integrity of the resulting data;
- obtaining and maintaining patent, trade secret and other intellectual property protection and regulatory exclusivity;
- ensuring we do not infringe, misappropriate or otherwise violate the patent, trade secret or other intellectual property rights of third parties;
- successfully launching our product candidates, if and when approved, cost effectively into multiple markets and geographies;
- obtaining favorable governmental and private medical reimbursement for our products, if and when approved;

RISK FACTORS

- competition with other diabetes management medical devices; and
- continued acceptable safety profile following regulatory approval.

If we do not achieve one or more of these factors in a timely manner or at all, we could experience significant delays or be unable to obtain approval for and/or to successfully commercialize our product candidates, which would materially harm our business and we may not be able to generate sufficient revenues and cash flows to continue our operations.

If we do not introduce new products in a timely manner, our products may become obsolete and our operating results may suffer.

The diabetes management medical devices industry is characterized by technological changes, frequent new product introductions, and evolving industry standards. Our competitors are also exploring newer technologies and developing products with advanced features. Without the timely introduction of new and improved products, our products could become technologically obsolete or more susceptible to competition and our revenue and operating results would suffer. Even if we develop new or improved products, our ability to market them could be limited by the need for regulatory clearance, restrictions imposed on approved indications, entrenched patterns of clinical practice, uncertainty over third-party reimbursement, or other factors. We devote significant financial and other resources to our R&D activities. We incurred R&D expenses of RMB50.1 million and RMB82.0 million in 2019 and 2020, which accounted for 96.5% and 108.9% of our total revenue in the same years, respectively. The R&D process is lengthy and entails considerable uncertainty. With respect to products we are currently developing, we may not complete the development process or obtain the regulatory or other approvals required to market such products in a timely manner or at all.

Technical innovations often require substantial time and investment before we can determine their commercial viability. We may not have the financial resources necessary to fund all of these projects. In addition, even if we are able to successfully develop new or improved products, they may not produce revenue in excess of the costs of development or achieve the desired financial return, and they may be rendered obsolete or less competitive by changing customer preferences or the introduction by our competitors of products with newer technologies or features or other factors.

Clinical product development involves a lengthy and expensive process with an uncertain outcome, and unsuccessful clinical trials or procedures relating to products under development could have a material adverse effect on our prospects.

Clinical testing is expensive and can take multiple years to complete, and its outcome is inherently uncertain. There can be no assurance that these trials or procedures will be completed in a timely or cost-effective manner or result in a commercially viable product or

RISK FACTORS

expanded indication. Failure to successfully complete these trials or procedures in a timely and cost-effective manner could have a material adverse effect on our prospects. Clinical trials or procedures may experience significant setbacks even after earlier trials have shown promising results.

Failure can occur at any time during the clinical trial process. The results of pre-clinical studies or other forms of early product testing do not necessarily predict future clinical trial results, and prior clinical trial results might not be repeated in subsequent clinical trials. We may be unable to demonstrate the safety and efficacy of our products in our clinical trials to the relevant regulatory authority’s satisfaction. In addition, there can be significant variability in safety and/or efficacy results between different trials of the same product candidate due to numerous factors, including changes in trial procedures set forth in protocols, differences in the size and type of the patient populations. In the case of any trials we conduct, results may differ from earlier trials due to the larger number of clinical trial sites and additional countries and languages involved in such trials.

Our future clinical trial results may not be favorable. Even if our future clinical trial results show favorable efficacy, not all patients may benefit. We may also conduct clinical studies to demonstrate the relative or comparative effectiveness of our products for the monitoring, treatment and management of diabetes. These types of studies, which often require substantial investment and effort, may not show adequate, or any, clinical benefit or value for the use of our products.

If clinical trials of our product candidates fail to demonstrate safety and efficacy to the satisfaction of regulatory authorities or do not otherwise produce positive results, we may incur additional costs or experience delays in completing, or ultimately be unable to complete, the development and commercialization of our product candidates.

Before obtaining regulatory approval for the sale of our product candidates, we must conduct extensive clinical trials to demonstrate the safety and efficacy of our product candidates in humans. We may experience numerous unexpected events during, or as a result of, clinical trials that could delay or prevent our ability to receive regulatory approval or commercialize our product candidates, including but not limited to:

- regulators, institutional review boards (“IRBs”) or ethics committees may not authorize us or our investigators to commence a clinical trial or conduct a clinical trial at a prospective trial site;
- our inability to reach agreements on acceptable terms with prospective CROs, SMOs and hospitals as trial centers, the terms of which can be subject to extensive negotiation and may vary significantly among different CROs, SMOs and hospitals as trial centers;
- manufacturing issues, including problems with manufacturing, supply quality, or obtaining sufficient quantities of a product candidate for use in a clinical trial;

RISK FACTORS

- clinical trials of our product candidates may produce negative (e.g. unsafe or inefficacious) or inconclusive results, and we may decide, or regulators may require us, to conduct additional clinical trials or abandon product development programs;
- the number of patients required for clinical trials of our product candidates may be larger than we anticipate, and enrollment may be insufficient or slower than we anticipate or patients may drop out at a higher rate than we anticipate;
- our third-party contractors may fail to comply with regulatory requirements or meet their contractual obligations to us in a timely manner, or at all;
- we might have to suspend or terminate clinical trials of our product candidates for various reasons, including a finding of a lack of clinical response or other unexpected characteristics or a finding that participants are being exposed to unacceptable health risks;
- regulators, IRBs or ethics committees may require that we or our investigators suspend or terminate clinical research or not rely on the results of clinical research for various reasons, including non-compliance with regulatory requirements;
- the cost of clinical trials of our product candidates may be greater than we anticipate; and
- the supply or quality of our product candidates, companion diagnostics or other materials necessary to conduct clinical trials of our product candidates may be insufficient or inadequate.

If we are required to conduct additional clinical trials or other testing of our product candidates beyond those that we currently contemplate, if we are unable to successfully complete clinical trials of our product candidates or other testing, if the results of these trials or tests are not positive or are only modestly positive or if they raise safety concerns, we may:

- be delayed in obtaining regulatory approval for our product candidates;
- not obtain regulatory approval at all;
- obtain approval for indications that are not as broad as intended;
- have the product removed from the market after obtaining regulatory approval;
- be subject to additional post-marketing testing requirements;
- be subject to restrictions on how the product is distributed or used; or
- be unable to obtain reimbursement for use of the product.

RISK FACTORS

If we experience delays in the completion of, or the termination of, a clinical trial of any of our product candidates, the commercial prospects of that product candidate will be harmed, and our ability to generate product sales revenues from any of those product candidates will be delayed. In addition, any delays in completing our clinical trials will increase our costs, slow down our product candidate development and approval process, and jeopardize our ability to commence product sales and generate related revenues for that candidate. Any of these occurrences may harm our business, financial condition and prospects significantly.

If we encounter difficulties enrolling patients in our clinical trials, our clinical development activities could be delayed or otherwise adversely affected.

The timely completion of clinical trials in accordance with their protocols depends, among other things, on our ability to enroll a sufficient number of patients who remain in the trial until its conclusion. We may experience difficulties in patient enrollment in our clinical trials for a variety of reasons, including the size and nature of the patient population and the patient eligibility criteria defined in the protocol.

Our clinical trials will likely compete with other clinical trials for product candidates that are in the same therapeutic areas as our product candidates. This competition will reduce the number and types of patients available to us, because some patients who might have opted to enroll in our trials may instead opt to enroll in a trial being conducted by one of our competitors. Because the number of qualified clinical investigators and clinical trial sites is limited, we may conduct some of our clinical trials at the same clinical trial sites that some of our competitors use, which will reduce the number of patients who are available for our clinical trials at such clinical trial sites. Even if we are able to enroll a sufficient number of patients in our clinical trials, delays in patient enrollment may result in increased costs or may affect the timing or outcome of the planned clinical trials, which could prevent completion of these trials and adversely affect our ability to advance the development of our product candidates.

Risks Relating to Extensive Government Regulations

All material aspects of the research, development and commercialization of our products are heavily regulated.

All jurisdictions in which we conduct our research, development and commercialization activities regulate these activities in great depth and detail. We intend to focus our activities in the major markets of China, the U.S. and the EU. These geopolitical areas all have strict regulation on medical devices, and in doing so they employ broadly similar regulatory strategies, including regulation of product development, approval, manufacturing, sales and marketing and distribution of medical devices. However, there are differences in the regulatory regimes in different regions, which makes regulatory compliance more complex and costly for companies like us that plan to operate in each of these regions.

RISK FACTORS

The process of obtaining regulatory approvals and compliance with appropriate laws and regulations require substantial time and financial resources. Failure to comply with the applicable requirements at any time during the product development process, approval process, or after approval, may subject an applicant to administrative or judicial sanctions. These sanctions could include a regulator's refusal to approve pending applications, withdrawal of an approval, license revocation, a clinical hold, voluntary or mandatory product recalls, product seizures, total or partial suspension of production or distribution, injunctions, fines, refusals of government contracts, restitution, disgorgement or civil or criminal penalties. The failure to comply with these regulations could have a material adverse effect on our business, financial condition and prospects.

If we are not able to obtain, or experience delays in obtaining, required regulatory approvals, we will not be able to commercialize our product candidates, and our ability to generate revenue will be materially impaired.

Before obtaining regulatory approvals for the commercial sale of any product candidate for a target indication, we must demonstrate in preclinical studies and well-controlled clinical trials, and, with respect to approval in China, to the satisfaction of the NMPA, that the product candidate is safe and effective for use for that target indication and that the manufacturing facilities, processes and controls are adequate. Obtaining regulatory approvals is a lengthy, expensive and uncertain process, and approvals may not be obtained. When we submit a filing application to the NMPA, the NMPA will decide whether to accept or reject the submission for filing. We cannot be certain that any submissions will be accepted for filing and review by the NMPA. NMPA may also slow down, suspend or cease review of our applications and any of these could prolong the registration process of our products.

Our product candidates could fail to receive regulatory approval for many reasons, including:

- failure to begin or complete preclinical studies or clinical trials due to disagreements with regulatory authorities;
- failure to demonstrate that a product candidate is safe and effective;
- failure to deliver clinical trial results that meet the level of statistical significance required for approval;
- data integrity issues related to our clinical trials;
- disagreement with our interpretation of data from preclinical studies or clinical trials;
- changes in approval policies or regulations that render our preclinical and clinical data insufficient for approval or require us to amend our clinical trial protocols;

RISK FACTORS

- regulatory requests for additional analyses, reports, data, nonclinical studies and clinical trials, or questions regarding interpretations of data and results and the emergence of new information regarding our product candidates or other products;
- our failure to conduct a clinical trial in accordance with regulatory requirements or our clinical trial protocols;
- clinical sites, investigators or other participants in our clinical trials deviating from a trial protocol, failing to conduct the trial in accordance with regulatory requirements, or dropping out of a trial; and/or
- rejection by the relevant authorities to approve pending applications or supplements to approved applications filed by us or suspension, revocation or withdrawal of approvals.

Regulatory authorities outside of China, such as the FDA and the European Medicine Agency (“**EMA**”), also have requirements for approval of medical devices for commercial sale with which we must comply prior to marketing in those areas. Regulatory requirements can vary widely from jurisdiction to jurisdiction and could delay or prevent the introduction of our product candidates. Clinical trials conducted in one jurisdiction may not be accepted by regulatory authorities in other jurisdictions, and obtaining regulatory approval in one jurisdiction does not mean that regulatory approval will be obtained in any other jurisdiction. Approval processes vary among jurisdictions and can involve additional product testing and validation and additional administrative review periods. Seeking foreign regulatory approval could require additional nonclinical studies or clinical trials, which could be costly and time consuming. The foreign regulatory approval process may include all of the risks associated with obtaining NMPA approval. For these reasons, we may not obtain foreign regulatory approvals on a timely basis, if at all.

Changes in regulatory requirements and guidance may also occur, and we may need to amend clinical trial protocols submitted to applicable regulatory authorities to reflect these changes. Amendments may require us to resubmit clinical trial protocols to IRBs or ethics committees for re-examination, which may impact the costs, timing or successful completion of a clinical trial.

The process to develop, obtain regulatory approval for and commercialize medical device product candidates is long, complex and costly both inside and outside China. Even if our product candidates were to successfully obtain approval from the regulatory authorities, any approval might significantly limit the approved indications for use, or require that precautions, contraindications or warnings be included on the product labeling, or require expensive and time-consuming post-approval clinical trials or surveillance as conditions of approval. Following an approval for commercial sale of our product candidates, certain changes to the product, such as changes in manufacturing processes and additional labeling claims, may be subject to additional review and approval by the NMPA, FDA, EMA and/or comparable regulatory authorities. Regulatory approvals for any of our product candidates may also be

RISK FACTORS

withdrawn. If we are unable to obtain regulatory approval for our product candidates in one or more jurisdictions, or any approval contains significant limitations, our target market will be reduced and our ability to realize the full market potential of our product candidates will be harmed. Furthermore, we may not be able to obtain sufficient funding or generate sufficient revenue and cash flows to continue the development of any other product candidate in the future.

Undesirable adverse events caused by our products and product candidates could interrupt, delay or halt clinical trials, delay or prevent regulatory approval, limit the commercial profile of an approved label, or result in significant negative consequences following any regulatory approval.

Undesirable adverse events caused by our products or product candidates could cause us or regulatory authorities to interrupt, delay or halt clinical trials and could result in a more restrictive label or the delay or denial of regulatory approval by the NMPA or other comparable regulatory authority, or could result in limitations or withdrawal following approvals. If results of our trials reveal a high and unacceptable severity or prevalence of adverse events, our trials could be suspended or terminated and the NMPA or other comparable regulatory authorities could order us to cease further development of, or deny approval of, our product candidates.

Adverse events were previously reported in our clinical trials. As of the Latest Practicable Date, these adverse events did not result in any product liability claims, or cause any adverse effect on our ability to enroll patients and complete the clinical trials. However, we cannot assure you that there would be no occurrence of adverse events or material adverse effect caused thereby. Any of these occurrences may harm our reputation, business, financial condition and prospects significantly. In this Document and from time to time, we disclose clinical results for our product candidates, including the occurrence of adverse events and serious adverse events. Each such document speaks only as of the date of the data cutoff used in such document, and we undertake no duty to update such information unless required by applicable law.

Our products and any future products will be subject to ongoing regulatory obligations and continued regulatory review, which may result in significant additional expense and we may be subject to penalties if we fail to comply with regulatory requirements or experience unanticipated problems with our products and/or product candidates.

Our products and any additional product candidates that are approved by the regulators are and will be subject to ongoing regulatory requirements with respect to manufacturing, labeling, packaging, storage, advertising, promotion, sampling, record-keeping, conduct of post-market studies, submission of safety, efficacy, and other post-market information, and other requirements of regulatory authorities in China, the U.S., the EU, and/or other jurisdictions.

RISK FACTORS

Manufacturers and manufacturers' facilities are required to comply with extensive regulatory requirements from the NMPA, the FDA, the EMA and/or other comparable authorities. As such, we are and will be subject to continual review and inspections by the regulators in order to assess our compliance with applicable laws and requirements and adherence to commitments we made in any application materials with the NMPA, the FDA, the EMA or other authorities. Accordingly, we must continue to devote time, money and effort in all areas of regulatory compliance.

The regulatory approvals for our products and any approvals that we receive for our product candidates are and may be subject to limitations on the indicated uses for which our product may be marketed. The approvals we obtain may also be subject to other conditions which may require potentially costly post-marketing testing and surveillance to monitor the safety and efficacy of our products or product candidates. Such limitations and conditions could adversely affect the commercial potential of our products.

The NMPA or comparable regulatory authorities may seek to impose a consent decree or withdraw marketing approval if we fail to maintain compliance with these ongoing regulatory requirements or if problems occur after the product reaches the market. Later discovery of previously unknown problems with our products or product candidates or with our manufacturing processes may result in revisions to the approved labeling or requirements to add new safety information; imposition of post-market studies or clinical studies to assess new safety risks; or imposition of distribution restrictions or other restrictions. Other potential consequences include, among other things:

- restrictions on the marketing or manufacturing of our products, withdrawal of the product from the market, or voluntary or mandatory product recalls;
- fines, untitled or warning letters, or holds on clinical trials;
- refusal by the NMPA or comparable regulatory authorities to approve pending applications or supplements to approved applications filed by us or suspension or revocation of license approvals or withdrawal of approvals;
- product seizure or detention, or refusal to permit the import or export of our products and product candidates; and/or
- injunctions or the imposition of civil or criminal penalties.

The NMPA, FDA, EMA and other regulatory authorities strictly regulate the marketing, labeling, advertising and promotion of products placed on the market. Products may be promoted only for their approved indications and for use in accordance with the provisions of the approved label. The NMPA, FDA, EMA and other regulatory authorities actively enforce the laws and regulations prohibiting the promotion of off-label uses, and a company that is found to have improperly promoted off-label uses may be subject to significant liability. The policies of the NMPA, FDA, EMA and other regulatory authorities may change and additional

RISK FACTORS

government regulations may be enacted that could prevent, limit or delay regulatory approval of our product candidates. We cannot predict the likelihood, nature or extent of governmental policies or regulations that may arise from future legislation or administrative actions in China or abroad, where the regulatory environment is constantly evolving. If we are slow or unable to adapt to changes in existing requirements or the adoption of new requirements or policies, or if we are unable to maintain regulatory compliance, we may lose any regulatory approval that we have obtained and we may not achieve or sustain profitability.

If our current and new products are not produced in compliance with the quality standards required under applicable laws, our business and reputation could be harmed, and our revenue and profitability could be materially and adversely affected.

Our production and manufacturing processes are required to meet certain quality standards. We have established a quality control and assurance system and adopted standardized operating procedures in order to prevent quality issues with respect to our products and operation processes. For further details of our quality control and assurance system, see “Business—Quality Control.” Despite our quality control and assurance system and procedures, we cannot eliminate the risk of product defects or failure. Quality defects may fail to be detected or remediated as a result of a number of factors, many of which are outside of our control, including:

- manufacturing errors;
- technical or mechanical malfunctions in the manufacture process;
- human error or malfeasance by our quality control personnel;
- tampering by third parties; and/or
- quality issues with the raw materials we produce or purchase.

In addition, failure to detect quality defects in our products or to prevent such defective products from being delivered to end-users could result in patient injury or death, product recalls or withdrawals, license revocation or regulatory fines, product liabilities or other problems that could seriously harm our reputation and business, expose us to liability, and materially and adversely affect our revenue and profitability.

Recently enacted and future legislation may increase the difficulty and cost for us to obtain regulatory approval of and commercialize our product candidates and affect the prices we may obtain.

In China, the United States, the EU and some other jurisdictions, a number of legislative and regulatory changes and proposed changes regarding healthcare could prevent or delay regulatory approval of our product candidates, restrict or regulate post-approval activities and affect our ability to profitably sell our products and any product candidates for which we obtain regulatory approval. In recent years, there have been and will likely continue to be efforts to

RISK FACTORS

enact administrative or legislative changes to healthcare laws and policies, including measures which may result in more rigorous coverage criteria and downward pressure on the price that we receive for any approved product. Any reduction in reimbursement from government programs may result in a similar reduction in payments from private payors. The implementation of cost containment measures or other healthcare reforms may prevent us from being able to generate revenue, attain profitability, or commercialize our products.

Legislative and regulatory proposals have been made to expand post-approval requirements and restrict sales and promotional activities for medical devices. We cannot be sure whether additional legislative changes will be enacted, or whether NMPA regulations, guidance or interpretations will be changed, or what the impact of such changes on the regulatory approvals of our product candidates, if any, may be. On February 9, 2021, the State Council approved an amendment to the Regulations on the Supervision and Administration of Medical Devices (the “**Amendment**”). As a medical device company, the requirements of clinical trial, sales and regulation would be changed under the Amendment. The impact of these more specific requirements and whether it will adversely affect the registration of our products with NMPA is yet to be observed.

We may be subject to complex and evolving laws and regulations regarding privacy and data protection. Actual or alleged failure to comply with privacy and data protection laws and regulations could damage our reputation, deter current and potential customers from using our products and could subject us to significant legal, financial and operational consequences.

In recent years, privacy and data protection has become an increasing regulatory focus of government authorities across the world. Particularly in China, where we operate substantially all our businesses, the PRC government has enacted a series of laws and regulations on the protection of personal data in the past few years. When conducting our business, we may have access to certain data of medical institutions and individual patients, including data collected during the course of continuous glucose monitoring and may be subject to laws and regulations regarding data privacy and protection in the relevant jurisdictions.

We have adopted various measures to ensure legal compliance. As confirmed by our PRC Legal Advisor, during the Track Record Period and up to the Latest Practicable Date, we were not subject to any material claims, lawsuits, penalties or administrative actions which had a material and adverse effect on our business, financial condition or results of operations relating to non-compliance with applicable PRC laws and regulations with respect to privacy and personal data protection. For details, see “Business—Data Privacy and Protection.” However, the laws and regulations regarding privacy and data protection in China, as well as other jurisdictions, are generally complex and evolving, with uncertainty as to the interpretation and application thereof. As such, we cannot assure you that our data privacy and protection measures are, and will be, always considered sufficient under applicable laws and regulations. Additionally, the integrity of our data privacy and protection measures is also subject to system failure, interruption, inadequacy, security breaches or cyber-attacks. If we are unable to comply

RISK FACTORS

with the then applicable laws and regulations, or to address any data privacy and protection concerns, such actual or alleged failure could damage our reputation, deter current and potential customers from using our solutions and could subject us to significant legal, financial and operational consequences.

Risks Relating to Commercialization and Distribution of Our Products

If our products cause, or are perceived to cause, severe adverse events, our reputation, revenue and profitability could be materially and adversely affected.

Our current and future products may cause undesirable or unintended severe adverse events as a result of a number of factors, many of which are outside of our control. These factors include potential complications not revealed in clinical trials, unusual but severe complications and adverse events in isolated cases, defective products not detected by our quality control system or misuse of our products. Our products may also be perceived to cause adverse events when a conclusive determination as to the cause of the adverse events is not obtained or is unobtainable.

In addition, our products may be perceived to cause severe adverse events if one or more regulators, such as the NMPA, the FDA and/or the EMA, determine that other companies' products containing the same or similar key parts or using the same delivery technologies as our products' cause or are perceived to have caused severe adverse events. If our products cause, or are perceived to cause, severe adverse events, we may face a number of consequences, including:

- injury or death of patients;
- a severe decrease in the demand for, and sales of, the relevant products;
- the recall or withdrawal of the relevant products;
- revocation of regulatory approvals for the relevant products or the relevant production facilities;
- damage to the brand name of our products and the reputation of our Company;
- removal of relevant products from the relevant medical insurance coverage; and/or
- exposure to lawsuits and regulatory investigation relating to the relevant products that result in liabilities, fines or penalties.

RISK FACTORS

As a result of these consequences, our sales, profitability and prospects could be materially and adversely affected.

Failure to achieve broad market acceptance or maintain good reputation necessary for our products and any future products would have a material adverse impact on our results of operations and profitability.

The commercial success of our current and future products depends upon the degree of market acceptance they achieve, particularly among patients and physicians. Our products may fail to receive broad acceptance from patients or physicians as anticipated. For example, tubeless patch insulin pumps was recently developed and introduced to the China market. Of all the insulin pump products currently approved in China, Equil is the only domestically developed patch insulin pump. If our products, such as Equil, and any future approved product candidates fail to gain sufficient market acceptance by physicians, patients, third-party payors and others in the industry, the sales of our products will be adversely affected. For example, while conventional insulin infusion sets and BGMS products have been long established, the monitoring, treatment and management of diabetes via patch insulin pumps and/or CGMS products is relatively new in China. Physicians and patients may continue relying on the conventional products due to limited public medical insurance coverage. In addition, many of our competitors have significantly greater financial resources and expertise and experience. Physicians, patients and third-party payors may prefer similar products or other novel products developed and marketed by these competitors. We may spend a lengthy period in improving our brand recognition and enhancing the awareness of the clinical advantages of our products and product candidates. Failure to achieve an adequate level of acceptance or to improve market awareness of our products and product candidates may have an adverse impact on our financial condition, business and results of operations. The degree of market acceptance of our products and product candidates, if approved for commercial sale, will depend on a number of factors, including:

- the clinical indications for which our products and product candidates are approved by the NMPA, the FDA, and the EMA and/or other authorities and the timing of such approval;
- the overall level of awareness of the clinical advantages of insulin pump therapy and continuous glucose monitoring;
- physicians, hospitals, and patients considering our products and product candidates as safe and effective;
- the potential and perceived advantages of our products and product candidates over alternative products;
- the prevalence and severity of any adverse effects or complications;
- product labeling or product insert requirements of regulatory authorities;

RISK FACTORS

- limitations or warnings contained in the labeling approved by regulatory authorities;
- the timing of market introduction of our products and product candidates as well as competitive products;
- greater name or brand recognition and more established medical product distribution channels by some of our competitors;
- the cost of treatment in relation to alternative treatments;
- the availability of adequate coverage, reimbursement and pricing by third-party payors and government authorities;
- the willingness of patients to pay out-of-pocket in the absence of coverage and reimbursement by third-party payors and government authorities;
- changes of governmental policies or guidelines in respect of diabetes treatment, monitoring and management;
- accelerated research and development progress of our competitors; and
- the effectiveness of our sales and marketing efforts.

If any products that we commercialize fail to achieve market acceptance among physicians, patients, hospitals, or others in the industry or if we fail to maintain good relationships with them, we will not be able to generate significant revenue. Even if our products achieve market acceptance, we may not be able to maintain that market acceptance over time if new products or technologies are introduced that are more favorably received than our products, are more cost effective or render our products obsolete.

We believe that maintaining and enhancing our brand identity and increasing market awareness of our Company and products is critical to achieving widespread acceptance of our services and products, strengthening our relationships with our existing clients and our ability to attract new clients. The successful promotion of our brand will depend largely on our ability to continue to offer high-quality products and our research and development efforts. However, there is no assurance that our brand promotion activities and research and development efforts may be successful or contribute to our growth. In addition, even if these activities increase revenue, the revenue may not be enough to offset the increased expenses we incur.

We have relatively limited experience in marketing and sales of our products and the commercialization of new products may require additional resources.

Equil received CE marking in Europe in June 2017 and the marketing approval by the NMPA, for adult use, in China in September 2017. AiDEX G7 received CE marking in September 2020, and we started to commercialize AiDEX G7 in Europe in March 2021. We

RISK FACTORS

have relatively limited experience in launching and commercializing our product candidates and sales and marketing of our products. For example, we have limited experience in building a commercial team, conducting a comprehensive market analysis, obtaining licenses and approvals, or managing distributors and sales force for our product candidates. As a result, our ability to successfully commercialize our product candidates may involve more inherent risks, take longer and cost more than it would if we were a company with sufficient experience launching product candidates.

The commercialization of new products require additional resources. The success of our sales and marketing efforts depends on our ability to attract, motivate and retain qualified and professional employees in our sales and marketing team who have, among other things, sufficient experience in sales and marketing of diabetes management medical devices and extensive industry connections with distributors and hospitals, and are able to communicate effectively with medical professionals. Furthermore, since we expect to launch new products, we expect to hire more employees with relevant medical device experience and knowledge to strengthen our marketing and sales workforce. However, due to the intense competition for experienced personnel, we may be unable to attract, motivate and retain a sufficient number of qualified sales and marketing employees to support our business development and expansion, and our sales revenue and results of operations may be negatively affected.

In addition, we plan to continue strengthening our cooperative relationship with hospitals, physicians and research institutions for enhancing our product awareness in the market. For example, we may perform on-site demonstration and regular visits in hospitals, collaborate with leading universities and research institutions, and cooperate with KOLs to conduct post-launch clinical studies to promote the market acceptance of our products. However, such promotional activities may not be as effective as we expected, or may be impeded by unanticipated events, which may cause a decline of our sales revenue, and have a material adverse effect on our business, financial condition and results of operations.

We rely on our in-house marketing force and third-party distributors to promote our products.

Under our strategic marketing model, our in-house marketing force and third-party distributors to market and promote our products. We incurred selling and distribution expenses of RMB27.0 million and RMB55.1 million for the years ended December 31, 2019 and 2020, respectively. The success of our marketing model depends on our ability to maintain and expand our relationships with qualified distributors, and our ability to attract, motivate and retain qualified and professional employees in our marketing, promotion and sales teams who have, among other things, the sufficient expertise in the diabetes areas and are able to communicate effectively with medical professionals. Competition for experienced marketing, promotion and sales personnel is intense. However, we would have little or no control over the marketing and sales efforts of the third-party distributors, and our revenue from product sales may be lower than if we had commercialized our products ourselves. We also face competition in our search for distributors to assist us with the sales and marketing efforts for our products. There can be no assurance that we will be able to develop and successfully maintain our

RISK FACTORS

in-house sales and commercial distribution capabilities or establish or maintain relationships with doctors, hospitals and other third parties to successfully commercialize our products. If we are unable to maintain and expand our relationships with qualified third-party distributors, or to attract, motivate and retain a sufficient number of qualified sales personnel to support our marketing model, sales volumes or margin of our existing and future products may be adversely affected and we may be unable to extend our hospital coverage and deepen our market penetration as contemplated.

If we fail to manage our distributors effectively, or fail to maintain, expand and optimize an effective distribution channel for our products, our business and sales of the relevant products could be adversely affected.

During the Track Record Period, we primarily rely on our network of distributors to distribute our products. Our ability to maintain and grow our business will depend on our ability to maintain, expand and optimize effective distribution channels that ensure timely distribution of our products to the relevant markets where we generate market demand through our sales and marketing activities. However, we have relatively limited control over our distributors, who may fail to distribute our products in the manner we contemplate, which may impair the effectiveness of our distribution network. Our distributors may take one or more of the following actions, any of which could have a material adverse effect on our business, prospects and reputation:

- failing to distribute our products in the manner we contemplate, impairing the effectiveness of our distribution network;
- breaching our agreements with them, including by selling products that have expired, or by selling products outside their designated territories or to hospitals other than their designated hospitals or engaging sub-distributors without our consent;
- failing to maintain the requisite licenses or otherwise failing to comply with applicable regulatory requirements when selling our products; and
- violating anti-corruption, anti-bribery, competition or other relevant laws and regulations.

Any violation or alleged violation by distributors of our distribution agreements or any applicable laws and regulations could result in the erosion of our goodwill, expose us to liabilities, disrupt our distribution network and create an unfavorable public perception about the quality of our products, resulting in a material adverse effect on our business, financial condition, results of operations and prospects. Since not all of our distributors may sell our products on an exclusive basis, our products may also compete with similar products from our competitors sold by our distributors.

RISK FACTORS

We typically enter into one-year agreements with our distributors. Our distributors might elect not to renew their agreements with us or otherwise terminate their business relationships with us for various reasons. For example, if price controls or other factors substantially reduce the margins they can obtain through the resale of our products to hospitals, pharmacies and individual customers, they may terminate their agreements with us. As of December 31, 2019 and 2020, we had a total of 271 and 370 distributors, respectively. For the years ended December 31, 2019 and 2020, the aggregate sales to our five largest distributors were RMB6.8 million and RMB11.2 million, representing 13.2% and 14.9% of our revenue, respectively. Sales to our largest distributor for the same periods were RMB1.6 million and RMB3.1 million, representing 3.1% and 4.1% of our revenue, respectively. If any of our major distributors, or a significant number of our distributors, voluntarily or involuntarily suspend or terminate their relationships with us, or we are otherwise unable to maintain and expand our distribution network effectively, our sales volumes and business prospects could be adversely affected. If we fail to maintain our relationship with our distributor in any territory, in particular, an overseas market, our sales and performance in such territory would be adversely affected, if we may not be able to enter into new distribution relationships with other distributors in a timely manner, or at all. Many factors can affect our ability to establish or maintain such relationships, including that we may fail to find an appropriate partner for a desired overseas market, the costs of doing so are prohibitively high or legal or administrative procedures are overly complex and time consuming.

Consequently, any disruption to our distribution network, including our failure to maintain relationships, form new relationships or renew our existing distribution agreements could negatively affect our ability to effectively sell our products and would materially and adversely affect our business, results of operations, financial condition and prospects. Additionally, in the event that a significant number of our distributors cease or reduce their purchases of our products or fail to meet the terms in our distribution agreements, our business, financial condition and results of operations may be materially and adversely affected.

If we experience delays in collecting payments from our distributors, our cash flows and operations could be adversely affected.

According to our trading terms with our customers, prepayment is normally required, except for certain customers, where credit period is allowed, and the credit period is generally within three months. As of December 31, 2019 and 2020, our trade receivables were RMB8.5 million and RMB11.5 million, respectively. The average turnover days of our trade receivables for the same periods were 48 days and 48 days, respectively. For our sales to distributors, our distributors receive payments from hospitals, pharmacies or individual customers for our products they sold to them, which could be used for payments to us. If our distributors' cash flows, working capital, financial condition or results of operations deteriorate or they experience delays in payments from the hospitals, pharmacies or individual customers, they may be unable, or they may otherwise be unwilling, to make payments owed to us promptly or at all. Any substantial defaults or delays could materially and adversely affect our cash flows, and we could be required to terminate our relationships with distributors in a manner that will impair the effective distribution of our products.

RISK FACTORS

We operate in a very competitive industry and if we fail to compete successfully against our existing or potential competitors, many of whom have greater resources than we have, which may result in others discovering, developing or commercializing competing products before or more successfully than we do, and our sales and operating results may be negatively affected.

The development and commercialization of insulin pump and CGMS products and other diabetes management medical devices is intensely competitive, subject to rapid change and highly sensitive to the introduction of new products or technologies, or other activities of industry participants. We face competition from major diabetes management medical device companies worldwide. A number of companies in the global market currently market and sell diabetes management medical devices or are pursuing the development of such products for the treatment, monitoring or management of diabetes. Potential competitors also include academic institutions, government agencies and other public and private research organizations that conduct research, seek patent protection and establish collaborative arrangements for research, development, manufacturing and commercialization.

Our commercial opportunities could be reduced or eliminated if our competitors develop and commercialize products that are safer, more effective, have fewer severe adverse events, are more convenient or are less expensive than any products that we commercialize or may develop. Our competitors may also be applying for marketing approvals in China or other countries for medical device products with the same intended use as our products and product candidates. The ability of the relevant authorities, such as the NMPA, to concurrently review multiple marketing applications for the same type of innovative medical device may be limited. When our product and its competing products are subject to the NMPA's concurrent review, the NMPA's schedule may be affected, and the registration process of our product may be prolonged. Moreover, our competitors may obtain approval from the NMPA, FDA, EMA or other comparable regulatory authorities for their products more rapidly than we obtain approval for ours, which could result in our competitors establishing a strong market position before we are able to enter the market and/or slow our regulatory approval.

Many of the companies against which we are competing have significantly greater financial resources and expertise in R&D, manufacturing, preclinical testing, conducting clinical trials, obtaining regulatory approvals and marketing approved products than we do. Mergers and acquisitions in the medical device industries may result in even more resources being concentrated among a small number of our competitors. Smaller and other early-stage companies may also prove to be significant competitors, particularly through collaborative arrangements with large and established companies. These third parties compete with us in recruiting and retaining qualified scientific and management personnel, establishing clinical trial sites and patient registration for clinical trials, as well as in acquiring technologies complementary to, or necessary for, our programs. Our business and results of operations will suffer if we fail to compete effectively.

RISK FACTORS

In addition, certain development efforts throughout the diabetes industry, including that of the governmental authorities and other supporters of diabetes research are continually seeking ways to prevent, cure or improve treatment and management of diabetes. Therefore, our products and product candidates may be rendered obsolete by technological breakthroughs in diabetes monitoring, treatment, prevention and cure.

Downward change in pricing of our products may have a material adverse effect on our business and results of operations.

In line with market practice, we sell a significant portion of our products to distributors who resell our products to hospitals, pharmacies or individual customers. In addition, we also sell a portion of our products directly to large retail pharmacies and individual customers. Our domestic distributors, or we in our direct sales to customers, negotiate and set retail prices directly with hospitals and other clients. Our domestic distributors shall not set any retail prices that are lower than the suggested resale prices set in the relevant distributorship agreement without our prior consent. The retail price of our products sold by our overseas distributors may vary from country to country, subject to factors such as prices of competing products and local insurance coverage. For details, see “Business—Sales and Marketing—Pricing.” Hospitals, among others, may gain more bargaining power depending on the availability of alternative products, demands of patients and the preference of physicians. If hospitals lower retail prices of our products and therefore reduce the profitability of our distributors, our distributors may have less incentive to purchase and promote our products, and we may need to lower the order price we set for our distributors.

As of the Latest Practicable Date, except for products purchased by state authorities, institutions and social organizations, in which case manufacturers should follow the government procurement procedures according to the Government Procurement Law and Bidding Law and other laws and regulations regarding government procurement and invitation to and submission of bids, there was generally no price guidance set on our products by the PRC government. Along with our increasing efforts to promote patch insulin pump products and CGMS products in the market, awareness of the clinical advantages of patch insulin pump products and CGMS products is expected to increase. More competing products may become available, which will offer alternatives for hospitals, other medical institutions and patients to choose. If the PRC government issues price guidance for patch insulin pump products and CGMS products, it may negatively affect the price of our products and therefore have a material adverse effect on our business and results of operations. We may also face downward pricing pressure if our products are included in the medical insurance reimbursement list.

Our sales may be affected by the level of medical insurance reimbursement patients receive for using our products.

Our ability to sell our products is related to the availability of governmental and private health insurance in China for treatments using our products. China has a complex medical insurance system that is undergoing reform. The governmental insurance coverage or reimbursement level in China for diabetes management medical devices is subject to

RISK FACTORS

significant uncertainty and varies from region to region, as local government approvals for such coverage must be obtained in each geographic region in China. In addition, the PRC government may change, reduce or eliminate the governmental insurance coverage then available for treatments using our products. We cannot assure you that our products and product candidates, if approved for commercial sale, will be included in the medical insurance reimbursement list at all times, or at all. To the extent that our products are not included in the medical insurance reimbursement list or if any such insurance schemes are changed or canceled which result in any removal of our products from the medical insurance catalog, patients may choose, and hospitals may recommend, alternative treatment methods.

In addition, insurance companies in China tend to reimburse patients for a higher percentage of the product cost if they use a medical device manufactured by a Chinese domestic company as opposed to an imported device. We cannot be certain that insurers will continue to adopt this favorable policy in the future.

In the absence of sufficient medical insurance coverage for the use of our products, patients may choose alternative treatment methods, and hospitals may recommend such alternative treatments, which would reduce demand for our products and our sales which could in turn materially and adversely affect our business, financial condition and results of operation.

Moreover, we may need to lower the prices of our products in order to have them included in the medical insurance reimbursement list, and such price cut and reimbursement may not necessarily lead to increase in our sales and our results of operations may be adversely affected.

Risks Relating to Manufacture and Supply of Our Products

Delays in completing and receiving regulatory approvals for our manufacturing facilities, or damage to, destruction of or interruption of production at such facilities, could delay our development plans or commercialization efforts.

Our principal manufacturing facilities are located at our headquarters in Hangzhou, Zhejiang Province, China. Our manufacturing facilities will be subject to ongoing, periodic inspection by the NMPA or other comparable regulatory agencies to ensure compliance with relevant standards and regulations. Failure to comply with applicable regulations could also result in sanctions being imposed on us, including fines, injunctions, civil penalties, requirement to suspend or put on hold one or more of our clinical trials, failure of regulatory authorities to grant marketing approval of our product candidates, delays, suspension or withdrawal of approvals, supply disruptions, license revocation, seizures or recalls of products or product candidates, operating restrictions and criminal prosecutions, any of which could harm our business.

RISK FACTORS

Our facilities may be harmed or rendered inoperable by physical damage from fire, floods, earthquakes, typhoons, tornadoes, power loss, telecommunications failures, break-ins, or other disruptive event, such as COVID-19 pandemic or another public health emergency, and similar events. If our manufacturing facilities or the equipment are damaged or destroyed, we may not be able to quickly or inexpensively replace our manufacturing capacity or replace it at all. In the event of a temporary or protracted loss of the facilities or equipment, we might not be able to transfer manufacturing to a third party. Even if we could transfer manufacturing to a third party, the shift would likely be expensive and time-consuming, particularly since the new facility would need to comply with the necessary regulatory requirements and we would need regulatory agency approval before selling any products manufactured at that facility. Such an event could delay our clinical trials or reduce our product sales. Any interruption in manufacturing operations at our manufacturing facilities could result in our inability to satisfy the demands of our clinical trials or commercialization. Any disruption that impedes our ability to manufacture our products or product candidates in a timely manner could materially harm our business, financial condition and operating results.

Currently, we maintain insurance coverage against damage to our property and equipment in amounts we believe are reasonable. However, our insurance coverage may not reimburse us, or may not be sufficient to reimburse us, for any expenses or losses we may suffer. We may be unable to meet our requirements for our products and product candidates if there were a catastrophic event or failure of our manufacturing facilities or processes.

If we fail to increase our production capacity as planned, our business prospects could be materially and adversely affected.

To produce our products in the quantities that we believe will be required to meet anticipated market demand for our products, we may need to increase, or scale up, the production capacity and the utilization rate. The utilization rate of the production line for the patch pump and PDA of Equil and the production line for disposables of Equil was 79.5% and 97.9% in 2020, respectively. Advances in manufacturing techniques may render our facilities and equipment inadequate or obsolete, and therefore we may also need to develop advanced manufacturing techniques and process controls in order to fully utilize our facilities. We typically require new employees to undergo a strict training and pass our evaluation before they commence work on our production lines. To enhance our production capacity, we also need to employ more workers. If we are unable to do so, or if the process to do so is delayed, or if the cost of this scale up is not economically feasible for us or we cannot find a third-party supplier, we may not be able to supply our products in a sufficient quantity to meet future demand, which would limit our development and commercialization activities and our opportunities for growth.

Our ability to successfully implement our expansion plan is subject to a number of risks, including our ability to obtain the requisite permits, licenses and approvals for the construction and operation of the new production lines, the risk of construction delays, as well as our ability to timely recruit sufficient qualified staff to support the increase in production capacity. Consequently, there can be no assurance that we will be able to increase our overall production

RISK FACTORS

capacity or develop advanced manufacturing techniques and process controls in the manner we contemplate, or at all. In the event we fail to increase our production capacity or develop advanced manufacturing techniques and process controls, we may not capture the expected growth in demand for our products, or to successfully commercialize new products, each of which could materially and adversely affect our business prospects. Moreover, our plans to increase our production capacity require significant capital investment, and the actual costs of our expansion plan may exceed our original estimates, which could materially and adversely affect the realization of expected return on our expenditures.

There can be no assurance that our existing and future production facilities will produce products in sufficient volumes in the event of any significant change in market demand. In such event, we may have to engage third parties to produce a portion of such products. Consequently, we are exposed to the risks of increased pricing for our sub-contracted production and that the third parties may not manufacture products meeting our specifications or in sufficient volumes to meet market demand. As a result, our sales volumes and margins for the relevant products could be materially and adversely affected.

The manufacture of our products is highly complex and subject to strict quality controls. If we or any of our suppliers or logistics partners encounters manufacturing, logistics, or quality problems, including as a result of natural disasters, our business could suffer.

The manufacture of many of our products is highly complex and subject to strict quality controls, due in part to rigorous regulatory requirements. In addition, quality is extremely important due to the serious and costly consequences of a product failure. Problems can arise during the manufacturing process for a number of reasons, including equipment malfunction, failure to follow protocols and procedures, raw material problems, software problems, or human error. Furthermore, if contaminants are discovered in our supply of our products or product candidates or in the manufacturing facilities, such manufacturing facilities may need to be closed for an extended period of time to investigate and remedy the contamination. Stability failures and other issues relating to the manufacture of our products or product candidates could occur in the future. Although closely managed, disruptions can occur during implementation of new equipment and systems to replace aging equipment, as well as during production line transfers and expansions. As we expand into new markets, we may face unanticipated surges in demands for our products which could strain our production capacity. If these problems arise or if we otherwise fail to meet our internal quality standards or those of the NMPA or other applicable regulatory body, which include detailed record-keeping requirements, our reputation could be damaged, we could become subject to a safety alert or a recall, we could incur product liability and other costs, product approvals could be delayed, and our business could otherwise be adversely affected.

In addition, our manufacturing and warehousing facilities, as well as those of our suppliers and logistics partners, could be materially damaged by earthquakes, hurricanes, volcanoes, fires, and other natural disasters or catastrophic circumstances, which could have a material adverse effect on our business.

RISK FACTORS

Fluctuations in prices of our raw materials may have a material adverse effect on us.

We rely on our suppliers for our business, which exposes us to risks associated with fluctuations in prices of raw materials, and reductions in the availability of raw materials may disrupt our operations. The prices of our raw materials may be affected by a number of factors, including market supply and demand, the PRC or international environmental and regulatory requirements, natural disasters, epidemics, the PRC and global economic conditions. During the Track Record Period, our principal raw materials were generally available and sufficient for our demands, and the price of the principal raw materials purchased from our suppliers was not materially affected by COVID-19. However, we cannot assure you that this will continue to be the case in the future. A significant increase in the costs of raw materials may increase our cost of sales and negatively affect our profit margins and, more generally, our business, financial condition, results of operation and prospects.

We may experience supply interruptions that could harm our ability to manufacture products.

We purchase certain of the materials and components used in the manufacture of our products from external suppliers, and we purchase certain supplies from fixed sources or single sources for reasons of quality assurance, cost efficiency, availability, or constraints resulting from regulatory requirements. Our principal raw materials are printed circuit boards, wafer parts, motors and LCD panels. We also purchase other raw materials, including packaging materials and plastic parts.

General economic conditions could adversely affect the financial viability of our suppliers, resulting in their inability to provide materials and components used in the manufacture of our products. While we work closely with suppliers to monitor their financial viability, assure continuity of supply, and maintain high quality and reliability, these efforts may not be successful. In addition, due to the rigorous regulations and requirements of the NMPA and/or foreign regulatory authorities regarding the manufacture of our products (including the need for approval of any change in supply arrangements), we may have difficulty establishing additional or replacement sources in a timely manner or at all if the need arises. Certain suppliers may also elect to no longer service medical device companies due to the high amount of requirements and regulation. We have available alternative supplier options. However the process of validating the regulatory qualifications of an alternative supplier may be time consuming, and a change in suppliers could require significant effort or investment in circumstances where the items supplied are integral to product performance or incorporate unique technology, and the loss of any existing supply contract could have a material adverse effect on us. A reduction in, or lack of availability of, raw materials or interruptions in the supply chain may also impact our profitability to the extent that we are required to pay higher prices for, or are unable to secure adequate supplies of, the necessary raw materials.

RISK FACTORS

Failure to maintain and predict inventory levels in line with the level of demand for our products could cause us to lose sales or face excess inventory risks and holding costs, either of which could have a material adverse effect on our business, financial condition and results of operations.

To operate our business successfully and meet our customers' demands and expectations, we must maintain a certain level of inventory for our products to ensure immediate delivery when required. Furthermore, we are required to maintain an appropriate level of inventory of our raw materials for our commercial production. For the years ended December 31, 2019 and 2020, our average inventory turnover days were 100 days and 126 days, respectively. However, we maintain our inventory levels based on our internal forecasts which are inherently uncertain. If our forecast demand is lower than actual demand, we may not be able to maintain an adequate inventory level of our products or produce our products in a timely manner, and may lose sales and market share to our competitors. On the other hand, we may be exposed to increased inventory risks due to accumulated excess inventory of our products or raw materials. Excess inventory levels may increase our inventory holding costs, risk of inventory obsolescence or write-offs.

In addition, we have established inventory policies, management procedures and provide adequate training sessions on inventory management, we actively monitor our inventory level and track the flow of our products in the operation of our business. However, there is no guarantee that the inventory information we collect is complete and accurate or that such information would allow us to effectively manage our inventory level. If we fail to maintain and predict inventory levels in line with the level of demand for our products, our business, financial condition and results of operations will be materially and adversely affected.

Risks Relating to Our Intellectual Property Rights

If we are unable to obtain and maintain patent protection for our products and product candidates through intellectual property rights, or if the scope of such intellectual property rights obtained is not sufficiently broad, third parties may compete directly against us.

Our success depends in large part on our ability to protect our proprietary technology, products and product candidates from competition by obtaining, maintaining and enforcing our intellectual property rights, including patent rights, and to maintain adequate legal protection for our technology and products in the PRC and worldwide. We seek to protect the technology, products and product candidates that we consider commercially important by filing patent applications in the PRC and worldwide, relying on trade secrets or medical regulatory protection or employing a combination of these methods. This process is expensive and time-consuming, and we may not be able to file and prosecute all necessary or desirable patent applications at a reasonable cost or in a timely manner. We may also fail to identify patentable aspects of our R&D output before it is too late to obtain patent protection. As a result, we may not be able to prevent competitors from developing and commercializing competitive products in all such fields and territories.

RISK FACTORS

Patents may be invalidated and patent applications may not be granted for a number of reasons, including known or unknown prior deficiencies in the patent application or the lack of novelty of the underlying invention or technology. We may also fail to identify patentable aspects of our R&D output in time to obtain patent protection. Although we enter into non-disclosure and confidentiality agreements or include such provisions in our relevant agreements with parties who have access to confidential or patentable aspects of our R&D output, such as our employees, consultants, advisors and other third parties, any of these parties may breach such agreements and disclose such output before a patent application is filed, jeopardizing our ability to seek patent protection. In addition, publications of discoveries in the scientific literature often lag behind the actual discoveries. Patent applications in China and other jurisdictions are typically not published until 18 months after filing, or in some cases, not at all.

Under the Patent Law of the PRC (中華人民共和國專利法) promulgated by the Standing Committee of the NPC, as amended, patent applications are maintained in confidence until their publication at the end of 18 months from the filing date. The publication of discoveries in the scientific or patent literature frequently occurs substantially later than the date on which the underlying discoveries were made and the date on which patent applications were filed. Therefore, we cannot be certain that we were the first to make the inventions claimed in our patents or pending patent applications or that we were the first to file for patent protection of such inventions.

Furthermore, the PRC and, recently, the United States have adopted the “first-to-file” system under which whoever first files a patent application will be awarded the patent if all other patentability requirements are met. Under the first-to-file system, even after reasonable investigation we may be unable to determine with certainty whether any of our products, processes, technologies, inventions, improvement and other related matters have infringed upon the intellectual property rights of others, because such third party may have filed a patent application without our knowledge while we are still developing that product, and the term of patent protection starts from the date the patent was filed, instead of the date it was issued. Therefore, the validity of issued patents, patentability of pending patent applications and applicability of any of them to our programs may be lower in priority than third-party patents issued on a later date if the application for such patents was filed prior to ours and the technologies underlying such patents are the same or substantially similar to ours. In addition, we may be involved in claims and disputes of intellectual property infringement in other jurisdictions (for example, in the United States). In addition, under PRC patent law, any organization or individual that applies for a patent in a foreign country for an invention or utility model accomplished in China is required to report to the China National Intellectual Property Administration (the “CNIPA”), for confidentiality examination. Otherwise, if an application is later filed in China, the patent right will not be granted.

The coverage claimed in a patent application can be significantly reduced before the patent is issued, and its scope can be reinterpreted after issuance. Even if patent applications we own currently or in the future are to be issued as patents, they may not be issued in a form that will provide us with any meaningful protection, prevent competitors or other third parties

RISK FACTORS

from competing with us, or otherwise provide us with any competitive advantage. In addition, the patent position of medical device companies generally is highly uncertain, involves complex legal and factual questions, and has been the subject of much litigation in recent years. As a result, the issuance, scope, validity, enforceability and commercial value of our patent rights are highly uncertain.

The issuance of a patent is not conclusive as to its inventorship, scope, validity or enforceability, and our patents may be challenged in the courts or patent offices in the PRC, the United States and other countries. We may be subject to a third-party preissuance submission of prior art to the CNIPA, the United States Patent and Trademark Office (the “USPTO”) or other related intellectual property offices, or become involved in post-grant proceedings such as opposition, derivation, revocation and re-examination, or *inter partes* review, or interference proceedings or similar proceedings in foreign jurisdictions challenging our patent rights or the patent rights of others. An adverse determination in any such submission, proceeding or litigation could reduce the scope of, or invalidate, our patent rights, allow third parties to commercialize our technology, products or product candidates and compete directly with us without payment to us, or result in our inability to manufacture or commercialize products and product candidates without infringing, misappropriating or otherwise violating third-party patent rights. Moreover, we may have to participate in interference proceedings declared by the CNIPA, USPTO or other related intellectual property offices to determine priority of invention or in post-grant challenge proceedings, such as oppositions in a foreign patent office, that challenge the priority of our invention or other features of patentability of our patents and patent applications. Such challenges may result in loss of patent rights, loss of exclusivity, or in patent claims being narrowed, invalidated, or held unenforceable, which could limit our ability to stop others from using or commercializing similar or identical technology and products, or limit the duration of the patent protection of our technology, products and product candidates. Such proceedings also may result in substantial costs and require significant time from our scientists, experts and management, even if the eventual outcome is favorable to us. Consequently, we do not know whether any of our technologies, products or product candidates will be protectable or remain protected by valid and enforceable patents. Our competitors or other third parties may be able to circumvent our patents by developing similar or alternative technologies or products in a non-infringing manner.

Furthermore, although various extensions may be available, the life of a patent and the protection it affords is limited. We may face competition for any approved product candidates even if we successfully obtain patent protection once the patent life has expired for the product. The issued patents and pending patent applications, if issued, for our products and product candidates are expected to expire on various dates as described in “Business—Intellectual Property Rights” of this Document. Upon the expiration of our issued patents or patents that may issue from our pending patent applications, we will not be able to assert such patent rights against potential competitors and our business and results of operations may be adversely affected.

RISK FACTORS

Given the amount of time required for the development, testing and regulatory review of new product candidates, patents protecting such product candidates might expire before or shortly after such product candidates are commercialized. As a result, our patents and patent applications may not provide us with sufficient rights to exclude others from commercializing products similar or identical to ours. Moreover, some of our patents and patent applications may in the future be co-owned with third parties. If we are unable to obtain an exclusive license to any such third-party co-owners' interest in such patents or patent applications, such co-owners may be able to license their rights to other third parties, including our competitors, and our competitors could market competing products and technology. In addition, we may need the cooperation of any such co-owners of our patents in order to enforce such patents against third parties, and such cooperation may not be provided to us. Any of the foregoing could have a material adverse effect on our competitive position, business, financial condition, results of operations and prospects.

We may not be able to protect our intellectual property rights.

Filing, prosecuting, maintaining and defending patents on products and product candidates in all countries throughout the world could be prohibitively expensive for us, and our intellectual property rights in some countries can have a different scope and strength from those in some other countries. In addition, the laws of certain countries do not protect intellectual property rights to the same extent as the laws of certain other countries do. Consequently, we may not be able to prevent third parties from practicing our inventions in all countries, or from selling or importing medical products made using our inventions in and into certain jurisdictions. Competitors may use our technologies in jurisdictions where we have not obtained patent protection to develop their own products and further, may export otherwise infringing products to certain jurisdictions where we have patent protection but where enforcement rights are not as strong as those in certain other countries. These products may compete with our products and product candidates and our patent rights or other intellectual property rights may not be effective or adequate to prevent them from competing.

As of the Latest Practicable Date, we owned 59 issued patents and pending patent applications. Any of these patents or patent applications may be the subject of a governmental or third-party objection, which could prevent the maintenance or issuance of the same. If we are unsuccessful in obtaining trademark protection for our primary brands, we may be required to change our brand names, which could materially adversely affect our business. Moreover, as our products mature, our reliance on our trademarks to differentiate us from our competitors will increase, and as a result, if we are unable to prevent third parties from adopting, registering or using trademarks and trade dress that infringe, dilute or otherwise violate our trademark rights, our business could be materially adversely affected.

Many companies have encountered significant problems in protecting and defending intellectual property rights in certain jurisdictions, including China. The legal systems of some countries do not favor the enforcement of patents, trade secrets and other intellectual property,

RISK FACTORS

particularly those relating to products, which could make it difficult in those jurisdictions for us to stop the infringement or misappropriation of our patents or other intellectual property rights, or the marketing of competing products in violation of our proprietary rights.

We may not prevail in any lawsuits that we initiate and the damages or other remedies awarded, if any, may not be commercially meaningful. Accordingly, our efforts to enforce our intellectual property rights around the world may be inadequate to obtain a significant commercial advantage from the intellectual property that we develop.

We may become involved in lawsuits to protect or enforce our intellectual property, which could be expensive, time consuming and unsuccessful. Our patent rights relating to our products and product candidates could be found invalid or unenforceable if being challenged in court or before the CNIPA or courts or related intellectual property agencies in other jurisdictions.

Competitors may infringe our patent rights or misappropriate or otherwise violate our intellectual property rights. To counter infringement or unauthorized use, litigation may be necessary in the future to enforce or defend our intellectual property rights, to protect our trade secrets or to determine the validity and scope of our own intellectual property rights or the proprietary rights of others. This can be expensive and time consuming. Any claims that we assert against perceived infringers could also provoke these parties to assert counterclaims against us alleging that we infringe their intellectual property rights. Many of our current and potential competitors have the ability to dedicate substantially greater resources to enforce and/or defend their intellectual property rights than we can. Accordingly, despite our efforts, we may not be able to prevent third parties from infringing upon or misappropriating our intellectual property. An adverse result in any litigation proceeding could put our patents, as well as any patents that may issue in the future from our pending patent applications, at risk of being invalidated, held unenforceable or interpreted narrowly. Furthermore, because of the substantial amount of discovery required in connection with intellectual property litigation, some of our confidential information could be compromised by disclosure during this type of litigation.

Defendant counterclaims alleging invalidity or unenforceability are commonplace, a third party can assert invalidity or unenforceability of a patent on numerous grounds. Third parties may also raise similar claims before administrative bodies in China or abroad, even outside the context of litigation. Such proceedings could result in revocation or amendment to our patents in such a way that they no longer cover and protect our products or product candidates. The outcome following legal assertions of invalidity and unenforceability is unpredictable. With respect to the validity of our patents, for example, we, our patent counsel, and the patent examiner could be unaware of invalidating prior art during prosecution. If a defendant were to prevail on a legal assertion of invalidity and/or unenforceability, we would lose at least part, and perhaps all, of the patent protection on our products or product candidates. Such a loss of patent protection could have a material adverse impact on our business.

RISK FACTORS

We may not be able to prevent misappropriation of our trade secrets or confidential information, particularly in countries where the laws may not protect those rights as fully as we expect.

If we are sued for infringing intellectual property rights of third parties, such litigation could be costly and time consuming and could affect the sales of our existing products or prevent or delay us from developing or commercializing our product candidates.

Our commercial success depends in part on our avoiding infringement of the patents and other intellectual property rights of third parties. We are aware of numerous issued patents and pending patent applications belonging to third parties that exist in fields in which we are selling our existing products and developing our product candidates. We may also be unaware of third-party patents or patent applications, and given the dynamic area in which we operate, additional patents are likely to be issued that relate to aspects of our business. There are a substantial amount of litigation and other claims and proceedings involving patent and other intellectual property rights in the medical devices industry generally. Companies operating in the medical devices industry routinely seek patent protection for their product designs, and many of them have large patent portfolios. Companies in the industry have used intellectual property litigations to gain a competitive advantage. As the medical devices industry expands and more patents are issued, the risk increases that our products and product candidates may give rise to claims of infringement of the patent rights of others. For example, certain patents granted to third parties have very broad claims, and it might be alleged that certain features of our products and product candidates fall within the claims of such patents owned by third parties. The validity and enforceability of these third-party patents might be questionable, because the scope of the patent claims is too broad and may lack novelty or inventiveness.

Third parties may assert that we are using technology in violation of their patent or other proprietary rights. Defense of these claims, regardless of their merit, could involve substantial litigation expense and divert our technical personnel, management personnel, or both from their normal responsibilities. Even in the absence of litigation, we may seek to obtain licenses from third parties to avoid the risks of litigation, and if a license is available, it could impose costly royalty and other fees and expenses on us.

If third parties bring successful claims against us for infringement of their intellectual property rights, we may be subject to injunctive or other equitable relief, which could prevent us from selling our existing products or developing and commercializing one or more of our product candidates. Defense of these claims, regardless of their merit, would involve substantial litigation expense and would substantially divert diversion of employee resources from our business. In the event of a successful claim against us of infringement or misappropriation, or a settlement by us of any such claims, we may have to pay substantial damages, including treble damages and attorneys' fees in the case of willful infringement, pay royalties or redesign our infringing products or product candidates, which may be impossible or require substantial time and cost. In the event of an adverse result in any such litigation, or even in the absence of litigation, we may need to obtain licenses from third parties to continue

RISK FACTORS

selling our existing products, advance our research or allow commercialization of our product candidates. Any such license might not be available on reasonable terms or at all. In the event that we are unable to obtain such a license, we would be unable to continue selling our existing products or further develop and commercialize one or more of our product candidates, which could harm our business significantly. We may also elect to enter into license agreements in order to settle patent infringement claims or to resolve disputes prior to litigation, and any such license agreements may require us to pay royalties and other fees that could significantly harm our business.

Even if litigation or other proceedings are resolved in our favor, there could be public announcements of the results of hearings, motions or other interim proceedings or developments, and if securities analysts or investors perceive these results to be negative, this could have a substantial adverse effect on the market price of our H Shares. Such litigation or proceedings could substantially increase our operating losses and reduce the resources available for development activities or any future sales, marketing or distribution activities. We may not have sufficient financial or other resources to adequately conduct such litigation or proceedings. Some of our competitors may be able to sustain the costs of such litigation or proceedings more effectively than we can because of their greater financial resources. Uncertainties resulting from the initiation and continuation of patent litigation or other proceedings could have a material adverse effect on our ability to compete in the marketplace.

Obtaining and maintaining our patent protection depends on compliance with various procedural, document submission, fee payment, and other requirements imposed by governmental patent agencies, and our patent protection could be reduced or eliminated for non-compliance with these requirements.

Periodic maintenance fees on any issued patent are due to be paid to the CNIPA, USPTO and other patent agencies in several stages over the lifetime of the patent. The CNIPA, USPTO and various governmental patent agencies require compliance with a number of procedural, documentary, fee payment, and other similar provisions during the patent application process. Although an inadvertent lapse can in many cases be cured by payment of a late fee or by other means in accordance with the applicable rules, non-compliance can result in abandonment or lapse of the patent or patent application, resulting in partial or complete loss of patent rights in the relevant jurisdiction. Non-compliance events that could result in abandonment or lapse of a patent or patent application include failure to respond to official actions within prescribed time limits, non-payment of fees, and failure to properly legalize and submit formal documents. In any such event, our competitors might be able to enter the market, which would have a material adverse effect on our business.

Changes in patent law could diminish the value of patents in general, thereby impairing our ability to protect our product candidates.

Depending on decisions by the NPC and the CNIPA, the laws and regulations governing patents could change in unpredictable ways that would weaken our ability to obtain new patents or to enforce our existing patents and patents that we might obtain in the future. The

RISK FACTORS

United States has enacted and is currently implementing wide-ranging patent reform legislation. Recent U.S. Supreme Court rulings have narrowed the scope of patent protection available in certain circumstances and weakened the rights of patent owners in certain situations. There could be similar changes in the laws of other jurisdictions that may impact the value of our patent rights or our other intellectual property rights. In addition to increasing uncertainty with regard to our ability to obtain patents in the future, this combination of events has created uncertainty with respect to the value of patents once obtained, if any.

If we are unable to protect the confidentiality of our trade secrets, our business and competitive position would be harmed. We may be subject to claims that our employees have wrongfully used or disclosed alleged trade secrets of their former employers.

In addition to our issued patent and pending patent applications, we rely on trade secrets, including unpatented know-how, technology and other proprietary information, to maintain our competitive position and to protect our products and product candidates. We seek to protect these trade secrets, in part, by entering into non-disclosure and confidentiality agreements or include such undertakings in the agreement with parties that have access to them, such as our employees, corporate collaborators, outside scientific collaborators, sponsored researchers, contract manufacturers, consultants, advisors and other third parties. We also enter into employment agreement or consulting agreement with our employees and consultants that includes undertakings regarding assignment of inventions and discoveries. However, any of these parties may breach such agreements and disclose our proprietary information, and we may not be able to obtain adequate remedies for such breaches. Enforcing a claim that a party illegally disclosed or misappropriated a trade secret can be difficult, expensive and time-consuming, and the outcome is unpredictable. If any of our trade secrets were lawfully obtained or independently developed by a competitor, we would have no right to prevent them from using that technology or information to compete with us and our competitive position would be harmed.

Furthermore, many of our employees, including our senior management, were previously employed at other medical device companies, including our competitors or potential competitors. There is possibility that we may be subject to claims that we or these employees have used or disclosed intellectual property, including trade secrets or other proprietary information, of any such employee's former employer. We are not aware of any material threatened or pending claims related to these matters or concerning the agreements with our senior management, but in the future litigation may be necessary to defend against such claims. If we fail in defending any such claims, in addition to paying monetary damages, we may lose valuable intellectual property rights or personnel. Even if we are successful in defending against such claims, litigation could result in substantial costs and be a distraction to management.

In addition, while we typically require our employees, consultants and contractors involved in the development of intellectual property to execute agreements assigning such intellectual property to us, we may be unsuccessful in executing such an agreement with each party who in fact develops intellectual property that we regard as our own, which may result

RISK FACTORS

in claims by or against us related to the ownership of such intellectual property. If we fail in prosecuting or defending any such claims, in addition to paying monetary damages, we may lose valuable intellectual property rights. Even if we are successful in prosecuting or defending against such claims, litigation could result in substantial costs and be a distraction to our management and scientific personnel.

Risks Relating to Our Reliance on Third Parties

If the third parties with which we contract for pre-clinical research and clinical trials do not perform in an acceptable manner, or if we suffer setbacks in these pre-clinical studies or clinical trials, we may be unable to develop and commercialize our product candidates as anticipated.

We rely on third parties, including academic institutions, hospitals, CROs and SMOs, to assist us in designing, implementing and monitoring our pre-clinical research and conducting clinical trials. As of the Latest Practicable Date, we worked with a number of CROs, SMOs and hospitals. If any of these parties terminates its agreements with us, the development of the product candidates covered by those agreements could be substantially delayed. In addition, these third parties may not successfully carry out their contractual obligations, meet expected deadlines or follow regulatory requirements, including clinical, laboratory and manufacturing guidelines. Our reliance on these third parties may result in delays in completing, or in failing to complete, these studies if they fail to perform in accordance with the contractual arrangements. Furthermore, if any of these parties fail to perform their obligations under our agreements with them in the manner specified in those agreements, the NMPA, the FDA, the EMA and/or other comparable regulatory authorities may not accept the data generated by those studies, which would increase the cost of and the development time for the relevant product candidate. If any of the pre-clinical studies or clinical trials of our product candidates is affected by any of the above-mentioned reasons, we will be unable to meet our anticipated development or commercialization timelines, which would have a material adverse effect on our business and prospects.

We rely upon strong relationships with certain key physicians and leading hospitals in the clinical development and marketing of our products.

The clinical development, marketing and sale of our products require us to maintain close relationships with physicians upon whom we rely to provide considerable knowledge and experience. These physicians may assist us as researchers, marketing consultants, trainers for CSII therapy and continuous glucose monitoring, inventors, and as public speakers. If we fail to develop or maintain strong relationships with these professionals or to continue to receive their advice and input, the development and marketing of our products could suffer, which could have a material adverse effect on our business, financial condition, and results of operations.

RISK FACTORS

We have entered into collaborations, and may establish or seek collaborations or strategic alliances or enter into licensing arrangements in the future, and we may not realize the benefits of such collaborations, alliances or licensing arrangements.

We may from time to time establish or seek strategic alliances, form joint ventures or collaborations, or enter into licensing arrangements with third parties that we believe will complement or augment our development and commercialization efforts with respect to our product candidates and any future product candidates that we may develop. For details, see “Business—Research and Development—Other Collaboration.”

We face significant competition in seeking appropriate strategic partners and the negotiation process for the collaboration, alliances or licensing arrangements can be time-consuming and complex. Moreover, we may not be successful in our efforts to establish a strategic partnership or other alternative arrangements for our product candidates because they may be deemed to be at too early of a development stage for collaborative effort and third parties may not view our product candidates as having the requisite potential to demonstrate safety and efficacy or commercial viability. If and when we collaborate with a third party for development and commercialization of a product candidate, we can expect to relinquish some or all of the control over the future success of that product candidate to the third party. For any products or product candidates that we may seek to in-license from third parties, we may face significant competition from other medical device companies with greater resources or capabilities than us, and any agreement that we do enter may not result in the anticipated benefits.

Further, collaborations involving our products and product candidates are subject to numerous risks, which may include the following:

- collaborators have significant discretion in determining the efforts and resources that they will apply to a collaboration;
- collaborators may not pursue development and commercialization of our product candidates or may elect not to continue or renew development or commercialization programs based on clinical trial results, or change their strategic focus due to the acquisition of competitive products, availability of funding, or other external factors, such as a business combination that diverts resources or creates competing priorities;
- collaborators may delay clinical trials, provide insufficient funding for a clinical trial, stop a clinical trial, abandon a product candidate, repeat or conduct new clinical trials, or require a new design of a product candidate for clinical testing;
- collaborators could independently develop, or develop with third parties, products that compete directly or indirectly with our products or product candidates;

RISK FACTORS

- a collaborator with marketing and distribution rights to one or more products may not commit sufficient resources to their marketing and distribution;
- collaborators may not properly maintain or defend our intellectual property rights or may use our intellectual property or proprietary information in a way that gives rise to actual or threatened litigation that could jeopardize or invalidate our intellectual property or proprietary information or expose us to potential liability;
- disputes may arise between us and a collaborator that cause the delay or termination of the research, development or commercialization of our product candidates, or that result in costly litigation or arbitration that diverts management attention and resources;
- collaborations may be terminated and, if terminated, may result in a need for additional capital to pursue further development or commercialization of the applicable product candidates; and/or
- collaborators may own or co-own intellectual property covering our products that results from our collaborating with them, and in such cases, we would not have the exclusive right to commercialize such intellectual property.

As a result, we may not be able to realize the benefit of current or future collaborations, strategic partnerships or the license of our third-party products if we are unable to successfully integrate such products with our existing operations and company culture, which could delay our timelines or otherwise adversely affect our business. We also cannot be certain that, following a strategic transaction or license, we will achieve the revenue or specific net income that justifies such transaction. If we are unable to reach agreements with suitable collaborators on a timely basis, on acceptable terms, or at all, we may have to curtail the development of a product candidate, reduce or delay its development program or one or more of our other development programs, delay its potential commercialization or reduce the scope of any sales or marketing activities, or increase our expenditures and undertake development or commercialization activities at our own expense. If we elect to fund and undertake development or commercialization activities on our own, we may need to obtain additional expertise and additional capital, which may not be available to us on acceptable terms or at all. If we fail to enter into collaborations and do not have sufficient funds or expertise to undertake the necessary development and commercialization activities, we may not be able to further develop our product candidates or bring them to market and generate product sales revenue, which would harm our business prospects, financial condition and results of operations.

RISK FACTORS

Our cross-border transfer of data may be limited or restricted.

The clinical trials, registration and post-marketing surveillance of our products and product candidates in different jurisdictions involve the collection and storage of personal health information for scientific purposes, and it may require cross-border transfer of personal or scientific data, which subjects us to relevant laws and regulations. As of the Latest Practicable Date, we had not been restricted from transferring data across jurisdictions for the purposes of medical device registration, however, our transfer of data may be limited or even restricted if the information is considered of national security interest in certain jurisdictions or if we fail to continue to comply with the requirement on data protection, in which case, our business may be harmed as a result.

On March 17, 2018, the General Office of the State Council promulgated the Measures for the Management of Scientific Data (《科學數據管理辦法》) (the “**Scientific Data Measures**”), which provide a broad definition of scientific data and relevant rules for the management of scientific data. According to the Scientific Data Measures, enterprises in China must seek governmental approval before any scientific data involving a state secret may be transferred abroad or to foreign parties. Further, any researcher conducting research funded at least in part by the Chinese government is required to submit relevant scientific data for management by the entity to which such researcher is affiliated before such data may be published in any foreign academic journal. Given the term state secret is not clearly defined, if and to the extent our R&D of medical device product candidates will be subject to the Scientific Data Measures and any subsequent laws as required by the relevant government authorities, we cannot assure you that we can always obtain relevant approvals for sending scientific data (such as the results of our pre-clinical studies or clinical trials conducted within China) abroad or to our foreign partners in China. If we are unable to obtain necessary approvals in a timely manner, or at all, our R&D of product candidates may be hindered, which may materially and adversely affect our business, results of operations, financial condition and prospects. If the relevant government authorities consider the transmission of our scientific data to be in violation of the requirements under the Scientific Data Measures, we may be subject to fines and other administrative penalties imposed by those government authorities. Moreover, Cyberspace Administration of China issued the Measures on Security Assessment of the Cross-border Transfer of Personal Information (Draft for Comment) (《個人信息出境安全評估辦法(徵求意見稿)》) in June 2019, pursuant to which, any cross-border transfer of information that may endanger national security, damage public interest, or fail to offer effective protection of personal information security, as assessed by relevant regulatory bodies, will be prohibited. Given that the government body will have full discretion in the assessment, it is unclear if and the extent to which our clinical data will be considered as an endangerment to national or personal information security, if the regulation becomes effective.

Cross-border data transfer from other jurisdictions may also be limited if we fail to comply with relevant requirements, such as obtaining authorization from patients regarding the use, transfer and retrieval of their personal information or data and adopting measures to ensure the safety of personal information or data in the transfer. For example, cross-border data transfer from the EU to abroad are governed by the General Data Protection Regulation. Also,

RISK FACTORS

cross-border transfer of personal data by its nature is subject to general data privacy regulations in various jurisdictions, and thus any failure to comply with data privacy protection may lead to a restriction of transferring our data across different jurisdictions.

RISKS RELATING TO OUR FINANCIAL POSITION AND NEED FOR ADDITIONAL CAPITAL

If we determine our intangible assets to be impaired, our results of operations and financial condition may be adversely affected.

As of December 31, 2020, we had intangible assets of RMB14.5 million which comprised of intellectual property and software. The value of intangible assets is based on a number of assumptions made by the management. For a detailed discussion on the intangible assets, see Note 15 to the Accountants’ Report in Appendix I to this Document. If any of these assumptions does not materialize, or if the performance of our business is not consistent with such assumptions, we may be required to have a significant write-off of our intangible assets and record a significant impairment loss. Furthermore, our determination on whether intangible assets are impaired requires an estimation of the carrying amount and recoverable amount of an intangible asset. If the carrying amount exceeds its recoverable amount, our other intangible assets may be impaired. The impairment of intangible assets could have a material adverse effect on our business, financial condition and results of operations. For more information regarding our impairment policy in relation to intangible assets, see Note 2.3 “Summary of Significant Accounting Policies—Intangible assets” and Note 3 “Significant Accounting Judgments and Estimates—Useful lives of intangible assets” to the Accountants’ Report in Appendix I to this Document.

We will need to obtain additional financing to fund our operations and we had net cash outflows from our operating activities during the Track Record Period. If we are unable to obtain that financing, we may be unable to complete the development and commercialization of our product candidates.

Our product candidates will require completion of clinical development, regulatory review, significant marketing efforts and substantial investment before they can provide us with product sales revenue. Our operations have consumed substantial amounts of cash since inception. We had net cash flow used in operating activities of RMB18.0 million and RMB9.6 million in 2019 and 2020, respectively. We cannot assure you that we will be able to generate positive cash flows from operating activities in the future. Our liquidity and financial condition may be materially and adversely affected by negative net cash flows, and we cannot assure you that we will have sufficient cash from other sources to fund our operations. If we resort to other financing activities to generate additional cash, we will incur financing costs and we cannot guarantee that we will be able to obtain the financing on terms acceptable to us, or at all, and if we raise finance by issuing further equity securities, your interest in our Company may be diluted. If we continue to have negative operating cash flows in the future, our liquidity and financial condition may be materially and adversely affected.

RISK FACTORS

We expect to continue to spend substantial amounts on R&D, advancing the clinical development of our product candidates, commercializing our products and launching and commercializing any product candidates for which we receive regulatory approval to address China and other markets. Our existing cash and cash equivalents may not be sufficient to enable us to complete all global development or commercially launch all of our current product candidates for the anticipated indications and to invest in additional programs. Accordingly, we will require further funding through public or private offerings, debt financing, collaboration and licensing arrangements or other sources. We cannot assure you that our financial resources will be adequate to support our operations. Our future funding requirements will depend on many factors, including:

- revenue and cash generated from our commercialized products;
- the progress, timing, scope and costs of our clinical trials, including the ability to timely enroll patients in our planned and potential future clinical trials;
- the outcome, timing and cost of regulatory approvals of our product candidates;
- the number and characteristics of product candidates that we may develop;
- selling and marketing costs associated with our products and any existing or future product candidates that may be approved, including the cost and timing of expanding our marketing and sales capabilities;
- the cost of filing, prosecuting, defending and enforcing any patent claims and other intellectual property rights;
- the terms and timing of any potential future collaborations, licensing or other arrangements that we may establish;
- cash requirements of any future acquisitions and/or the development of other product candidates;
- the cost and timing of development and completion of commercial-scale internal or outsourced, if any, manufacturing activities; and/or
- our headcount growth and associated costs.

Adequate additional funding may not be available to us on acceptable terms, or at all. If we are unable to raise capital when needed or on attractive terms, we would be forced to delay, reduce or eliminate our R&D programs or future commercialization efforts.

RISK FACTORS

The discontinuation of any government grants and other favorable policies currently available to us could adversely affect our financial condition, results of operations and prospects.

We have historically received government grants in the form of subsidies. For the years ended December 31, 2019 and 2020, we recognized government grants as other income and gains of RMB2.2 million and RMB19.2 million, respectively. For further details of our government grants, see “Financial Information.” Moreover, our growth has also been supported by favorable government policies. The timing, amount and criteria of government grants and other favorable policies are determined within the sole discretion of the local government authorities and cannot be predicted with certainty before we actually receive any financial incentive. We generally do not have the ability to influence local governments in making these decisions. Local governments may decide to reduce or eliminate such grants or policies at any time. Our eligibility for government grants is dependent on a variety of factors, including the assessment of our improvement on existing technologies, relevant government policies, the availability of funding at different granting authorities and the R&D progress made by other peer companies. In addition, some of the government grants and policies are on a project basis and subject to the satisfaction of certain conditions, including compliance with the applicable financial incentive agreements and completion of the specific projects therein. Moreover, the policies according to which we historically received government grants may be halted by the relevant government entities at their sole discretion. We cannot assure you of the continued availability of the government grants and other favorable policies currently enjoyed by us. Any reduction or elimination of such government grants and other policies would materially adversely affect our business, financial condition, results of operations and prospects.

Raising additional capital may cause dilution to our Shareholders, restrict our operations or require us to relinquish rights to our technologies or product candidates.

We may seek additional funding through a combination of equity offerings, debt financings, collaborations and licensing arrangements. To the extent that we raise additional capital through the sale of equity or convertible debt securities, your ownership interest will be diluted, and the terms may include liquidation or other preferences that adversely affect your rights as a holder of our H Shares. The incurrence of additional indebtedness or the issuance of certain equity securities could result in increased fixed payment obligations and could also result in certain additional restrictive covenants, such as limitations on our ability to incur additional debt or issue additional equity, limitations on our ability to acquire or license intellectual property rights and other operating restrictions that could adversely impact our ability to conduct our business. In addition, issuance of additional equity securities, or the possibility of such issuance, may cause the market price of our H Shares to decline. In the event that we enter into collaborations or licensing arrangements in order to raise capital, we may be required to accept unfavorable terms, including relinquishing or licensing to a third party on unfavorable terms our rights to technologies or product candidates that we otherwise would seek to develop or commercialize ourselves or potentially reserve for future potential arrangements when we might be able to achieve more favorable terms.

RISK FACTORS

Share-based payment may cause shareholding dilution to our existing Shareholders and have a material and adverse effect on our financial performance.

We adopted Employee Incentive Schemes for the benefit of our employees (including directors) as remuneration for their services provided to us to incentivize and reward the eligible persons who have contributed to the success of our Company. For details, see “Appendix VI—Statutory and General Information—Further Information about our Directors, Supervisors, Senior Management and Substantial Shareholders—5. Employee Incentive Schemes.” In 2019 and 2020, we incurred equity-settled share award expense of RMB57.6 million and RMB111.2 million, respectively. To further incentivize our employees to contribute to us, we may grant additional share-based compensation in the future. Issuance of additional Shares with respect to such share-based payment may dilute the shareholding percentage of our existing Shareholders. Expenses incurred with respect to such share-based payment may also increase our operating expenses and therefore have a material and adverse effect on our financial performance.

RISKS RELATING TO OUR OPERATIONS

Our operations and business plans may be adversely affected by natural disasters, health epidemics and pandemics, civil and social disruption and other outbreaks, in particular the COVID-19 outbreak.

An outbreak of a respiratory disease COVID-19 was first reported in December 2019 and continues to expand globally. In March 2020, the World Health Organization characterized the COVID-19 outbreak as a global pandemic. Significant rises in COVID-19 cases have been reported since then, causing governments around the world to implement unprecedented measures such as city lockdowns, travel restrictions, quarantines and business shutdowns. The COVID-19 outbreak is expected to have an unprecedented impact on the global economy as it has significantly reduced market liquidity and depressed economic activities.

The COVID-19 outbreak has caused and may continue to cause a long-term adverse impact on the economy and social conditions in China and other affected countries, which may have an indirect impact on our industry and cause temporary suspension of projects and shortage of labor and raw materials, which would severely disrupt our operations and have a material adverse effect on our business, financial condition and results of operations. During the COVID-19 outbreak, reduced transportations and social distancing policies have affected the organization of conferences, seminars and other offline sales and marketing activities, in particular, interactions with overseas clients. As a result, the demand for our products in China and overseas decreased, which adversely affected our financial performance in the first quarter of 2020. While the COVID-19 situation has gradually improved in China and our business started to recover and gradually resumed growth since the second quarter of 2020, we are uncertain as to when the COVID-19 outbreak will be contained globally. As of the Latest Practicable Date, the COVID-19 pandemic had not been contained in Europe and thus our access to local markets and sales and marketing activities there were limited, which negatively impacted our market expansion and sales growth. We have mobilized internal and external resources to minimize the adverse effect on our business caused by the COVID-19 outbreak. However, we also cannot predict whether COVID-19 will have long-term impact on our business operations. The full impact of the virus on our operations will depend on many factors, including further surges or variations of COVID-19 and the success of vaccination efforts, which are beyond our control.

RISK FACTORS

Our operations could also be disrupted if any of our employees or employees of our distributors, suppliers and other business partners were suspected of contracting or contracted COVID-19, since this could require us and our distributors, suppliers and other business partners to quarantine some or all of these employees and disinfect facilities used for operations. In addition, the commencement of new clinical trials for product candidates in our development pipeline could also be delayed or prevented by any delay or failure in subject recruitment or enrollment. Our commercialization plan for commercial-ready or near commercial-ready assets could also be disrupted. If we are not able to effectively and efficiently develop and commercialize our product candidates as planned, we may not be able to grow our business and generate revenue from sales of our product candidates as anticipated, our business operations, financial condition and prospects may subsequently be materially and adversely affected.

In addition, any future occurrence of force majeure events, natural disasters or outbreaks of other epidemics and contagious diseases, including avian influenza, severe acute respiratory syndrome, swine influenza caused by the H1N1 virus, or H1N1 influenza or the Ebola virus, may materially and adversely affect our business, financial condition and results of operations. Moreover, the PRC has experienced natural disasters such as earthquakes, floods and droughts in the past few years. Any future occurrence of severe natural disasters in China may materially and adversely affect its economy and our business. We cannot assure you that any future occurrence of natural disasters or outbreaks of epidemics and contagious diseases or the measures taken by the Chinese government or other countries in response to such contagious diseases will not seriously disrupt our operations or those of our customers, which may materially and adversely affect our business, financial condition and results of operations.

Our future success depends on our ability to retain key personnel in our R&D team, sales and marketing team and executives and to attract, retain and motivate qualified personnel.

Our business and growth depend on the continued service of our senior management and personnel in our R&D team to develop product candidates and our sales and marketing team to promote our products. Although we have formal employment agreements with each of our employees, these agreements do not prevent them from terminating their employment with us at any time. As of the date of this Document, we did not maintain key person insurance for any of our executives or other employees. The loss of the services of any of these persons could impede the achievement of our research, development and commercialization objectives.

To induce valuable employees to remain at our Company, in addition to salary and cash incentives, we have provided share awards to our employees. The value to employees of these equity grants may be significantly affected by movements in the H Share price that are beyond our control, and may at any time be insufficient to counteract more lucrative offers from other companies. Although we have employment agreements with our key employees, any of our employees could leave our employment at any time, with or without notice.

RISK FACTORS

In addition, we rely on consultants and advisors, including scientific and clinical advisors, to assist us in formulating our discovery, clinical development and commercialization strategy. The loss of the services of our executive officers or other key employees and consultants could impede the achievement of our research, development and commercialization objectives and seriously harm our ability to successfully implement our business strategy.

Furthermore, replacing executive officers, key employees or consultants may be difficult and may take an extended period of time because of the limited number of individuals in our industry with the breadth of skills and experience required to successfully develop, gain regulatory approval of and commercialize products. Competition to hire from this limited pool is intense, and we may be unable to hire, train, retain or motivate these key personnel or consultants on acceptable terms given the competition among numerous medical device companies for similar personnel.

We also experience competition for the hiring of R&D and clinical personnel from universities and research institutions. Our consultants and advisors may be engaged by our competitors and may have commitments under consulting or advisory contracts with other entities that may limit their availability to us. If we are unable to continue to attract and retain high quality personnel, our ability to pursue our growth strategy will be limited.

We are a commercial-stage medical device company with a limited operating history, which may make it difficult to evaluate our current business and predict our future performance.

During the Track Record Period, we generated revenue from the sales of Equil, BGMS and other. Equil received CE marking in Europe in June 2017 and the marketing approval by the NMPA, for adult use, in China in September 2017. AiDEX G7 received CE marking in September 2020, and we started to commercialize AiDEX G7 in Europe in March 2021. As of the Latest Practicable Date, we had not yet obtained NMPA approval or approvals from other comparable authorities for AiDEX G7, among others. Our limited operating history, particularly in light of the rapidly evolving diabetes treatment and management field, may make it difficult to evaluate our current business and reliably predict our future performance. We may encounter unforeseen expenses, difficulties, complications, delays and other known and unknown factors. If we do not address these risks and difficulties successfully, our business will suffer.

We have significantly increased the size and capabilities of our organization, and we may experience difficulties in managing our growth.

As our development and commercialization plans and strategies evolve, we need to recruit a significant number of additional managerial, operational, manufacturing, sales, marketing, financial and other personnel. Our recent growth and any future growth will impose significant added responsibilities on members of management, including:

- identifying, recruiting, integrating, maintaining and motivating additional employees;

RISK FACTORS

- managing our internal development efforts effectively, including the clinical and regulatory authority review process for our product candidates, while complying with our contractual obligations to contractors and other third parties; and
- improving our operational, financial and management controls, reporting systems and procedures.

Our future financial performance and our ability to commercialize our products and product candidates will depend, in part, on our ability to effectively manage our recent growth and any future growth, and our management may also have to divert a disproportionate amount of its attention away from day-to-day activities in order to devote a substantial amount of time to managing these growth activities.

We currently rely, and for the foreseeable future will continue to rely, in substantial part on certain independent organizations, advisors and consultants to provide certain services. There can be no assurance that the services of these independent organizations, advisors and consultants will continue to be available to us on a timely basis when needed, or that we can find qualified replacements. There can be no assurance that we will be able to manage our existing consultants or find other competent outside contractors and consultants on economically reasonable terms, if at all.

If we are not able to effectively manage our growth and further expand our organization by hiring new employees and expanding our groups of consultants and contractors as needed, we may not be able to successfully implement the tasks necessary to further develop and commercialize our products and product candidates and, accordingly, may not achieve our research, development and commercialization goals.

If we engage in acquisitions or strategic partnerships, this may increase our capital requirements, dilute our Shareholders, cause us to incur debt or assume contingent liabilities, and subject us to other risks.

From time to time, we may evaluate various acquisitions and strategic partnerships, including licensing or acquiring complementary products, intellectual property rights, technologies or businesses. Any completed, in-process or potential acquisition or strategic partnership may entail numerous risks, including:

- increased operating expenses and cash requirements;
- the assumption of additional indebtedness or contingent or unforeseen liabilities;
- the issuance of our equity securities;
- assimilation of operations, intellectual property and products of an acquired company, including difficulties associated with integrating new personnel;

RISK FACTORS

- the diversion of our management's attention from our existing product programs and initiatives in pursuing such a strategic merger or acquisition;
- retention of key employees, the loss of key personnel, and uncertainties in our ability to maintain key business relationships;
- risks and uncertainties associated with the other party to such a transaction, including the prospects of that party and their existing products and product candidates and regulatory approvals; and/or
- our inability to generate revenue from acquired technology and/or products sufficient to meet our objectives in undertaking the acquisition or even to offset the associated acquisition and maintenance costs.

In addition, if we undertake acquisitions, we may issue securities, assume or incur debt obligations, incur large one-time expenses and acquire intangible assets that could result in significant future amortization expense.

Product liability claims or lawsuits could cause us to incur substantial liabilities.

We face an inherent risk of product liability as a result of the commercialization of our products in China and other jurisdictions, as well as the clinical testing and any future commercialization of our product candidates globally. For example, we may be sued if our products or product candidates cause or are perceived to cause injury or are found to be otherwise unsuitable during clinical testing, manufacturing, marketing or sale. Any such product liability claims may include allegations of defects in manufacturing, defects in design, a failure to warn of dangers inherent in the medical device product, negligence, strict liability or a breach of warranties. Claims could also be asserted under applicable consumer protection acts. If we cannot successfully defend ourselves against or obtain indemnification from our collaborators for product liability claims, we may incur substantial liabilities or be required to limit commercialization of our products and product candidates. Even successful defense would require significant financial and management resources. Regardless of the merits or eventual outcome, liability claims may result in:

- decreased demand for our products;
- injury to our reputation;
- withdrawal of clinical trial participants and inability to continue clinical trials;
- initiation of investigations by regulators;
- costs to defend the related litigation;
- a diversion of management's time and our resources;

RISK FACTORS

- substantial monetary awards to trial participants or patients, product recalls, withdrawals or labeling, marketing or promotional restrictions;
- loss of revenue;
- exhaustion of any available insurance and our capital resources;
- the inability to commercialize any product candidate; and/or
- a decline in our H Share price.

If we are unable to obtain sufficient product liability insurance at an acceptable cost, potential product liability claims could prevent or inhibit the commercialization of our products and product candidates. We currently do not hold any product liability insurance coverage, and we may be unable to acquire such insurance at a reasonable cost or in an amount adequate to satisfy any liability that may arise, or we may not be able to obtain additional or replacement insurance at a reasonable cost, if at all. Our insurance policies may also have various exclusions, and we may be subject to a product liability claim for which we have no coverage. We may have to pay any amounts awarded by a court or negotiated in a settlement that exceed our coverage limitations or that are not covered by our insurance, and we may not have, or be able to obtain, sufficient capital to pay such amounts. Even if our agreements with any future collaborators entitle us to indemnification against losses, such indemnification may not be available or adequate should any claim arise.

If we become subject to litigation, legal or contractual disputes, governmental investigations or administrative proceedings, our management's attention may be diverted and we may incur substantial costs and liabilities.

We may from time to time become subject to various litigation, legal or contractual disputes, investigations or administrative proceedings arising in the ordinary course of our business, including but not limited to various disputes with or claims from our suppliers, customers, contractors, business partners and other third parties that we engage for our business operations. On-going or threatened litigation, legal or contractual disputes, investigations or administrative proceedings may divert our management's attention and consume their time and our other resources. In addition, any similar claims, disputes or legal proceedings involving us or our employees may result in damages or liabilities, as well as legal and other costs and may cause a distraction to our management. Furthermore, any litigation, legal or contractual disputes, investigations or administrative proceedings which are initially not of material importance may escalate and become important to us, due to a variety of factors, such as the facts and circumstances of the cases, the likelihood of loss, the monetary amount at stake and the parties involved. If any verdict or award is rendered against us or if we settle with any third parties, we could be required to pay significant monetary damages, assume other liabilities and even to suspend or terminate the related business projects. In addition, negative publicity arising from litigation, legal or contractual disputes, investigations or administrative

RISK FACTORS

proceedings may damage our reputation and adversely affect the image of our brands and products. Consequently, our business, financial condition and results of operations may be materially and adversely affected.

We may be subject, directly or indirectly, to applicable anti-kickback, false claims laws, physician payment transparency laws, fraud and abuse laws or similar healthcare and security laws and regulations in China and other jurisdictions, which could expose us to criminal sanctions, civil penalties, contractual damages, reputational harm and diminished profits and future earnings.

Healthcare providers, physicians and others play a primary role in the recommendation and prescription of any products for which we obtain regulatory approval. Our operations are subject to various applicable anti-kickback, false claims laws, physician payment transparency laws, fraud and abuse laws or similar healthcare and security laws and regulations in China, including, without limitation, criminal law of the PRC, Regulations on the Supervision and Administration of Medical Devices (醫療器械監督管理條例) and the Administrative Measures for the Registration of Medical Devices (醫療器械註冊管理辦法). These laws may impact, among other things, our proposed sales, marketing and education programs. In addition, we may be subject to patient privacy regulation. Violations of fraud and abuse laws may be punishable by criminal and/or civil sanctions, including penalties, fines and/or exclusion or suspension from governmental healthcare programs and debarment from contracting with the PRC government.

Neither the PRC government nor the PRC courts have provided definitive guidance on the applicability of fraud and abuse laws to our business. Law enforcement authorities are increasingly focused on enforcing these laws, and some of our practices may be challenged under these laws. Efforts to ensure that our business arrangements with third parties comply with applicable healthcare laws and regulations will involve substantial costs. Governmental authorities could conclude that our business practices may not comply with current or future statutes, regulations or case law involving applicable fraud and abuse or other healthcare laws and regulations. If any such actions are instituted against us, and we are not successful in defending ourselves or asserting our rights, those actions could have a significant impact on our business, including the imposition of civil, criminal and administrative penalties, damages, disgorgement, monetary fines, possible exclusion from participation in governmental healthcare programs, contractual damages, reputational harm, diminished profits and future earnings, and curtailment of our operations, any of which could adversely affect our ability to operate our business and our results of operations. In addition, we are subject to equivalents of each of the healthcare laws described above in other jurisdictions, among others, some of which may be broader in scope and may apply to healthcare services reimbursed by any source, not just governmental payors, including private insurers. There are ambiguities as to what is required to comply with these requirements, and if we fail to comply with an applicable law requirement, we could be subject to penalties.

RISK FACTORS

If any of the physicians or other providers or entities with whom we do business are found to be not in compliance with applicable laws, they may be subject to criminal, civil or administrative sanctions, including exclusions from government funded healthcare programs, which may also adversely affect our business.

If we fail to comply with applicable anti-bribery laws, our reputation may be harmed and we could be subject to penalties and significant expenses that have a material adverse effect on our business, financial condition and results of operations.

We are subject to the anti-bribery laws of China and other jurisdictions. As our business expands, the applicability of the applicable anti-bribery laws to our operations has increased. Our procedures and controls to monitor compliance with anti-bribery law may fail to protect us from reckless or criminal acts committed by our employees or agents. If we fail to comply with the applicable anti-bribery laws due to either our own deliberate or inadvertent acts or those of others, our reputation could be harmed and we could incur criminal or civil penalties, other sanctions and/or significant expenses, which could have a material adverse effect on our business, including our financial condition, results of operations, cash flows and prospects.

If we fail to comply with environmental, health and safety laws and regulations, we could become subject to fines or penalties or incur costs that could have a material adverse effect on the success of our business.

We are subject to numerous environmental, health and safety laws and regulations, including those governing laboratory procedures and the handling, use, storage, treatment and disposal of hazardous materials and wastes. Our operations involve the use of hazardous and flammable materials, including chemicals. Our operations also produce hazardous waste. We generally contract with third parties for the disposal of these materials and wastes. We cannot eliminate the risk of contamination or injury from these materials. In the event of contamination or injury resulting from our use of hazardous materials, we could be held liable for any resulting damages, and any liability could exceed our resources. We could also incur significant costs associated with civil or criminal fines and penalties.

Although we maintain workers' compensation insurance to cover us for costs and expenses we may incur due to injuries to our employees resulting from the use of or exposure to hazardous materials, this insurance may not provide adequate coverage against potential liabilities. We do not maintain insurance for environmental liability or toxic tort claims that may be asserted against us in connection with our storage, use or disposal of biological or hazardous materials.

In addition, we may be required to incur substantial costs to comply with current or future environmental, health and safety laws and regulations. These current or future laws and regulations may impair our research, development or production efforts. Failure to comply with these laws and regulations also may result in substantial fines, penalties or other sanctions.

RISK FACTORS

Our internal computer systems may fail or suffer security breaches.

Despite the implementation of security measures, our internal computer systems are vulnerable to damage from computer viruses and unauthorized access, including unauthorized access to patient data and personally identifiable information stored in our information systems. Although to our knowledge we have not experienced any material system failure or security breach to date, if such an event were to occur and cause interruptions in our operations, it could result in a material disruption of our development programs and our business operations.

In the ordinary course of our business, we collect and store sensitive data, including, among other things, legally protected patient health information, personally identifiable information about our employees, intellectual property, and proprietary business information. We manage and maintain our applications and data utilizing on-site systems and outsourced vendors. These applications and data encompass a wide variety of business critical information including R&D information, commercial information and business and financial information. Because information systems, networks and other technologies are critical to many of our operating activities, shutdowns or service disruptions at our Company or vendors that provide information systems, networks, or other services to us pose increasing risks. Such disruptions may be caused by events such as computer hacking, phishing attacks, ransomware, dissemination of computer viruses, worms and other destructive or disruptive software, denial of service attacks and other malicious activity, as well as power outages, natural disasters (including extreme weather), terrorist attacks or other similar events. Such events could have an adverse impact on us and our business, including loss of data and damage to equipment and data. In addition, system redundancy may be ineffective or inadequate, and our disaster recovery planning may not be sufficient to cover all eventualities. Significant events could result in a disruption of our operations, damage to our reputation or a loss of revenues. In addition, we may not have adequate insurance coverage to compensate for any losses associated with such events.

We could be subject to risks caused by misappropriation, misuse, leakage, falsification or intentional or accidental release or loss of information maintained in the information systems and networks of our Company and our vendors, including personal information of our employees and patients, and company and vendor confidential data. In addition, outside parties may attempt to penetrate our systems or those of our vendors or fraudulently induce our personnel or the personnel of our vendors to disclose sensitive information in order to gain access to our data and/or systems. Like other companies, we have on occasion experienced, and will continue to experience, threats to our data and systems, including malicious codes and viruses, phishing, and other cyber-attacks. The number and complexity of these threats continue to increase over time. If a material breach of our information technology systems or those of our vendors occurs, the market perception of the effectiveness of our security measures could be harmed and our reputation and credibility could be damaged. We could be required to expend significant amounts of money and other resources to repair or replace information systems or networks. In addition, we could be subject to regulatory actions and/or claims made by individuals and groups in private litigation involving privacy issues related to

RISK FACTORS

data collection and use practices and other data privacy laws and regulations, including claims for misuse or inappropriate disclosure of data, as well as unfair or deceptive practices. Although we develop and maintain systems and controls designed to prevent these events from occurring, the development and maintenance of these systems, controls and processes is costly and requires ongoing monitoring and updating as technologies change and efforts to overcome security measures become increasingly sophisticated. Moreover, despite our efforts, the possibility of these events occurring cannot be eliminated entirely. As we outsource more of our information systems to vendors, engage in more electronic transactions with payors and patients, and rely more on cloud-based information systems, the related security risks will increase and we will need to expend additional resources to protect our technology and information systems.

If we or parties on whom we rely fail to maintain the necessary licenses for the development, production, sales and distribution of our products, our ability to conduct our business could be materially impaired.

We are required to obtain, maintain and renew various permits, licenses and certificates to develop, produce, promote and sell our products. Third parties, such as research institutions, distributors and suppliers on whom we may rely to develop, produce, promote, sell and distribute our products, may be subject to similar requirements. We and third parties on whom we rely may be also subject to regular inspections, examinations, inquiries or audits by regulatory authorities, and an adverse outcome of such inspections, examinations, inquiries or audits may result in the loss or non-renewal of the relevant permits, licenses and certificates. Moreover, the criteria used in reviewing applications for, or renewals of permits, licenses and certificates may change from time to time, and there can be no assurance that we or the third parties on whom we rely will be able to meet new criteria that may be imposed to obtain or renew the necessary permits, licenses and certificates. Many of such permits, licenses and certificates are material to the operation of our business, and if we or parties on whom we rely fail to maintain or renew material permits, licenses and certificates, our ability to conduct our business could be materially impaired. Furthermore, if the interpretation or implementation of existing laws and regulations change, or new regulations come into effect, requiring us or parties on whom we rely to obtain any additional permits, licenses or certificates that were previously not required to operate our business, there can be no assurance that we or parties on whom we rely will successfully obtain such permits, licenses or certificates.

Business disruptions could seriously harm our future revenue and financial condition and increase our costs and expenses.

Our operations, and those of our third-party research institution collaborators, suppliers and other contractors and consultants, could be subject to natural or man-made disasters or business interruptions, for which we are predominantly self-insured. The occurrence of any of these business disruptions could seriously harm our operations and financial condition and increase our costs and expenses. Our ability to obtain supplies of our products and product candidates could be disrupted if the operations of these suppliers are affected by a man-made or natural disaster or other business interruption. Damage or extended periods of interruption

RISK FACTORS

to our corporate, development, research or manufacturing facilities due to fire, natural disaster, power loss, communications failure, unauthorized entry or other events could cause us to cease or delay development or commercialization of some or all of our product candidates. Our business may be seriously harmed by such delays and interruption.

If we fail to effectively expand our international business, our business prospects may be adversely affected.

We plan to broaden our sales network and further expand our presence globally especially in the U.S. and the EU. However, our limited experience in overseas markets may expose us to risks and uncertainties, including the risks associated with the following:

- dealing with regulatory regimes, regulatory bodies and government policies which may differ materially from those in the PRC or with which we may be unfamiliar;
- substantial time which may be required for us to obtain approval for registering and selling our products in additional countries, especially in developed countries;
- commercializing our products in new markets where we have limited experience with the dynamics and no sales and marketing infrastructure;
- higher costs for new product development and reliance on overseas partners for the development, commercialization and marketing of our products;
- product liability litigation and regulatory scrutiny arising from the marketing and sale of products in overseas markets and the costs incurred dealing with such procedures, as well as our ability to obtain insurance to adequately protect us from any resulting liabilities;
- unexpected changes in tariffs, trade barriers and regulatory requirements;
- economic weakness and inflation;
- difficulty of effective enforcement of contractual provisions in local jurisdictions;
- compliance with tax, employment, immigration and labor laws for employees traveling abroad;
- the effects of applicable foreign tax structures and potentially adverse tax consequences;
- currency fluctuations, which could result in increased operating expenses and reduced revenue;

RISK FACTORS

- workforce uncertainty and labor unrest; and
- business interruptions resulting from geo-political actions, including war and terrorism, or natural disasters, including earthquakes, volcanoes, typhoons, floods, hurricanes and fires.

Our insurance coverage may not completely cover the risks related to our business and operations.

Our operations are subject to hazards and risks associated with our research and manufacturing operations, which may cause significant harm to persons or damage to properties. We maintain insurance policies covering our production facilities and equipment that we believe are sufficient in accordance with customary industry practice. We do not carry any product liability insurance or business interruption insurance. For details, see “Business—Insurance.” There is no assurance that our insurance policies will be adequate to cover all losses incurred. Losses incurred and associated liabilities may have a material adverse effect on our results of operation if such losses or liabilities are not covered by our insurance policies.

Negative publicity and allegations involving us, our Shareholders, Directors, officers, employees and business partners may affect our reputation and, as a result, our business, financial condition and results of operations may be negatively affected.

We, our Shareholders, Directors, officers, employees and business partners may be subject to negative media coverage and publicity from time to time. Such negative coverage in the media and publicity could threaten the perception of our reputation. In addition, to the extent our employees and business partners were in compliance with any laws or regulations, we may also suffer negative publicity or harm to our reputation. As a result, we may be required to spend significant time and incur substantial costs in response to allegations and negative publicity, and may not be able to diffuse them to the satisfaction of our [REDACTED] and customers.

RISKS RELATING TO DOING BUSINESS IN CHINA

The medical devices industry in China is highly regulated and such regulations are subject to change which may affect approval and commercialization of our product candidates.

We conduct the majority of our operations in China. The medical devices industry in China is subject to comprehensive government regulation and supervision, encompassing the approval, registration, manufacturing, packaging, licensing and marketing of new devices. In recent years, the regulatory framework in China regarding the medical devices industry has undergone significant changes, and we expect that it will continue to undergo significant changes. Any such changes or amendments may result in increased compliance costs on our business or cause delays in or prevent the successful development or commercialization of our product candidates in China and reduce the benefits we believe are available to us from developing and manufacturing our product candidates in China.

RISK FACTORS

Changes in the political and economic policies of the PRC government may materially and adversely affect our business, financial condition and results of operations and may result in our inability to sustain our growth and expansion strategies.

Due to our extensive operations in China, our business, results of operations, financial condition and prospects may be influenced to a significant degree by economic, political, legal and social conditions in China. China’s economy differs from the economies of developed countries in many respects, including with respect to the amount of government involvement, level of development, growth rate, control of foreign exchange and allocation of resources.

While the PRC economy has experienced significant growth over the past 30 years, growth has been uneven across different regions and among various economic sectors of China. The PRC government has implemented various measures to encourage economic development and guide the allocation of resources. Some of these measures may benefit the overall PRC economy, but may have a negative effect on us. For example, our financial condition and results of operations may be adversely affected by government control over capital investments or changes in tax regulations that are currently applicable to us. In addition, in the past, the PRC government implemented certain measures, including interest rate increases, to control the pace of economic growth. These measures may cause decreased economic activity in China, which may adversely affect our business and results of operation. More generally, if the business environment in China deteriorates from the perspective of domestic or international investment, our business in China may also be adversely affected.

There are uncertainties regarding the interpretation and enforcement of PRC laws, rules and regulations.

The majority of our operations are conducted in China, and are governed by PRC laws, rules and regulations. The PRC legal system is a civil law system based on written statutes. Unlike the common law system, prior court decisions may be cited for reference but have limited precedential value.

In 1979, the PRC government began to promulgate a comprehensive system of laws, rules and regulations governing economic matters in general. The overall effect of legislation over the past three decades has significantly enhanced the protections afforded to various forms of foreign investment in China. However, China has not developed a fully integrated legal system, and recently enacted laws, rules and regulations may not sufficiently cover all aspects of economic activities in China or may be subject to significant degrees of interpretation by PRC regulatory agencies. In particular, because these laws, rules and regulations are relatively new and often give the relevant regulator significant discretion in how to enforce them, and because of the limited number of published decisions and the non-binding nature of such decisions, the interpretation and enforcement of these laws, rules and regulations involve uncertainties and can be inconsistent and unpredictable. In addition, the PRC legal system is based in part on government policies and internal rules, some of which are not published on a timely basis or at all, and which may have a retroactive effect. As a result, we may not be aware of our violation of these policies and rules until after the occurrence of the violation.

RISK FACTORS

Additionally, the reform of the medical device approval system in 2017 may face implementation challenges. The timing and full impact of such reforms is uncertain and could prevent us from commercializing our product candidates in a timely manner. In addition, any administrative and court proceedings in China may be protracted, resulting in substantial costs and diversion of resources and management attention. Since PRC administrative and court authorities have significant discretion in interpreting and implementing statutory and contractual terms, it may be more difficult to evaluate the outcome of administrative and court proceedings and the level of legal protection we enjoy than in more developed legal systems. These uncertainties may impede our ability to enforce the contracts we have entered into and could materially and adversely affect our business, financial condition and results of operations.

You may experience difficulties in effecting service of legal process and enforcing judgments against us and our management based on Hong Kong or other foreign laws.

We are incorporated under the laws of the PRC, and substantially all of our assets are located in the PRC. In addition, a majority of our Directors, Supervisors and senior management personnel reside within the PRC, and substantially all of their assets are located within the PRC. As a result, it may not be possible to effect service of process within the United States or elsewhere outside the PRC upon our Directors, Supervisors and senior management personnel, including with respect to matters arising under the U.S. federal securities laws or applicable state securities laws.

On July 14, 2006, the Supreme People’s Court of the PRC and the government of Hong Kong Special Administrative Region entered into the Arrangement on Reciprocal Recognition and Enforcement of Judgments in Civil and Commercial Matters by the Courts of the Mainland and of the Hong Kong Special Administrative Region Pursuant to Choice of Court Agreements between Parties Concerned (關於內地與香港特別行政區法院相互認可和執行當事人協議管轄的民商事案件判決的安排) (the “**Arrangement**”). Under the Arrangement, where any designated PRC court or any designated Hong Kong court has made an enforceable final judgment requiring payment of money in a civil or commercial case under a choice of court agreement in writing, any party concerned may apply to the relevant PRC court or Hong Kong court for recognition and enforcement of the judgment. A choice of court agreement in writing is defined as any agreement in writing entered into between parties after the effective date of the Arrangement in which a Hong Kong court or a PRC court is expressly selected as the court having sole jurisdiction for the dispute. Therefore, it is not possible to enforce a judgment rendered by a Hong Kong court in the PRC if the parties in dispute have not agreed to enter into a choice of court agreement in writing. Although the Arrangement became effective on August 1, 2008, the outcome and effectiveness of any action brought under the Arrangement remain uncertain. In addition, the PRC has not entered into a treaty for the reciprocal recognition and enforcement of court judgments with the United States, the United Kingdom, Japan and most other western countries, and Hong Kong has no arrangement for the reciprocal enforcement of judgments with the United States. As a result, recognition and enforcement in the PRC or Hong Kong of judgment of a court in the United States or any other jurisdictions mentioned above in relation to any matter that is not subject to a binding arbitration provision may be difficult or impossible.

RISK FACTORS

We are a PRC enterprise and we are subject to PRC tax on our global income, and the dividends payable to [REDACTED] and gains on the sale of our H Shares by our [REDACTED] are subject to PRC tax.

As a PRC-incorporated company, we are subject to a tax of 25% on our global income. Our Company has been qualified as a high and new technology enterprise, and accordingly is entitled to the preferential income tax rate of 15% in the Track Record Period. Under applicable PRC tax laws, regulations and statutory documents, non-PRC resident individuals and enterprises are subject to different tax obligations with respect to dividends received from us or gains realized upon the sale or other disposition of our H Shares. Non-PRC individuals are generally subject to PRC individual income tax under the Individual Income Tax Law of the PRC (中華人民共和國個人所得稅法) with respect to PRC source income or gains at a rate of 20% unless specifically exempted by the tax authority of the State Council or reduced or eliminated by an applicable tax treaty. We are required to withhold related tax from dividend payments. Pursuant to applicable regulations, PRC companies issuing shares in Hong Kong may generally, when distributing dividends, withhold individual income tax at the rate of 10%. However, withholding tax on distributions paid by us to non-PRC individuals may be imposed at other rates pursuant to applicable tax treaties (and up to 20% if no tax treaty is applicable) if the identity of the individual holder of H shares and the tax rate applicable thereto are known to us. There is uncertainty as to whether gains realized upon disposition of H shares by non-PRC individuals are subject to PRC individual income tax.

Non-PRC resident enterprises that do not have establishments or premises in the PRC, or that have establishments or premises in the PRC but their income is not related to such establishments or premises are subject to PRC EIT at the rate of 10% on dividends received from PRC companies and gains realized upon disposition of equity interests in the PRC companies pursuant to the EIT Law and other applicable PRC tax regulations and statutory documents, which may be reduced or eliminated under special arrangements or applicable treaties between the PRC and the jurisdiction where the non-resident enterprise resides. Pursuant to applicable regulations, we intend to withhold tax at a rate of 10% from dividends paid to non-PRC resident enterprise holders of our H Shares (including HKSCC Nominees). Non-PRC resident enterprises that are entitled to be taxed at a reduced rate under an applicable income tax treaty will be required to apply to the PRC tax authorities for a refund of any amount withheld in excess of the applicable treaty rate, and payment of such refund will be subject to the PRC tax authorities' verification. As of the Latest Practicable Date, there were no specific rules on how to levy tax on gains realized by non-resident enterprise holders of H shares through the sale or transfer by other means of H shares.

There remains significant uncertainty as to the interpretation and application of the relevant PRC tax laws by the PRC tax authorities, including whether and how individual income tax or EIT on gains derived by holders of our H Shares from their disposition of our Shares may be collected. If any such tax is collected, the value of our Shares may be materially and adversely affected.

RISK FACTORS

Payment of dividends is subject to restrictions under PRC law and regulations.

Under PRC law and regulations, we may only pay dividends out of distributable profits. Distributable profits are our after-tax profits, less any recovery of accumulated losses and appropriations to statutory and other reserves that we are required to make. As a result, we may not have sufficient or any distributable profit to enable us to make dividend distributions to our Shareholders, including in periods for which our financial statements indicate we are profitable. Any distributable profit not distributed in a given year is retained and available for distribution in subsequent years.

Moreover, our subsidiary in the PRC may not have distributable profit as determined under PRC GAAP. Accordingly, we may not receive sufficient distributions from our subsidiary for us to pay dividends. Failure by our subsidiary to pay us dividends could adversely impact our ability to make dividend distributions to our Shareholders and our cash flow, including periods in which we are profitable.

We may be subject to penalties under relevant PRC laws and regulations due to failure to be in full compliance with social insurance and housing provident fund regulation.

According to the Social Insurance Law of the PRC promulgated in 2010 and most recently amended in 2018 and the Regulations on Management of Housing Provident Funds promulgated in 1999 and most recently amended in 2019, within a prescribed time limit, we need to register with the relevant social security authority and housing provident fund management center, and to open the relevant accounts and make full contributions to social insurance and housing funds for our employees, and this obligation cannot be delegated to any third party.

Our contributions for some of our employees to the social insurance and housing funds may not have been in compliance with relevant PRC laws and regulations. During the Track Record Period and as of the Latest Practicable Date, we did not make full contributions to the social insurance and housing funds for certain employees in accordance with the relevant PRC laws and regulations. We made provisions of RMB2.1 million as of December 31, 2020 in connection with the shortfall amount of the social insurance and housing provident fund contribution during the Track Record Period. We had not been subject to any administrative actions, fines or penalties during the Track Record Period and up to the Latest Practicable Date due to such non-compliance and we had not received any notification from the relevant PRC authorities requiring us to pay for the shortfalls or any overdue charges with respect to social insurance and housing funds as of the Latest Practicable Date. During the Track Record Period and as of the Latest Practicable Date, we engaged third-party human resources agencies to pay social insurance and housing funds for certain employees, primarily due to the preference of such employees to participate in local social insurance and housing fund schemes in their place of residency. Under the agreements entered into between such third-party human resources agencies and us, the third-party human resources agencies have the obligations to pay social insurance premium and housing funds for our relevant employees. However, if the human resource agencies fail to pay the social insurance or housing fund contributions for and behalf of our employees as required under applicable PRC laws and regulations, we may be subject

RISK FACTORS

to penalties imposed by the local social insurance authorities and the local housing fund management centers for failing to discharge our obligations in relation to payment of social insurance and housing funds as an employer. These third-party human resources agencies have confirmed in writing that they have paid such contributions in compliance with applicable laws and regulations. As of the Latest Practicable Date, we had not received any administrative penalty or labor arbitration application from employees for our agency arrangement with third-party human resources agencies. For details, see “Business—Legal Proceedings and Compliance.”

On July 20, 2018, the General Office of the Central Committee of the Communist Party of China and the General Office of the State Council of the PRC issued the Reform Plan of the State Tax and Local Tax Collection Administration System, or the Tax Reform Plan. Under the Tax Reform Plan, commencing from January 1, 2019, tax authorities are responsible for the collection of social insurance contributions in the PRC. The effect of the Tax Reform Plan is still uncertain. We cannot assure that we will not be required to pay any deemed shortfalls or be subject to penalties or fines regarding social security insurance and housing provident funds contributions, any of which may have an adverse effect on our business and results of operations.

Governmental control of currency conversion, and restrictions on the remittance of Renminbi into and out of China, may adversely affect the value of your [REDACTED].

The Renminbi is not currently a freely convertible currency, as the PRC government imposes controls on the convertibility of Renminbi into foreign currencies and, in certain cases, the remittance of currency out of China. A substantial portion of our revenue is denominated in Renminbi and we will need to convert Renminbi into foreign currencies for the payment of dividends, if any, to holders of our H Shares. Shortages in the availability of foreign currency may restrict our ability to remit sufficient foreign currency to pay dividends or other payments, or otherwise satisfy our foreign currency-denominated obligations. Under China’s current foreign exchange control system, foreign exchange transactions under the current account conducted by us, including the payment of dividends, do not require advance approvals from SAFE, but we are required to present relevant documentary evidence of such transactions and conduct such transactions at designated foreign exchange banks within the PRC that have the licenses to carry out foreign exchange business. Approvals from appropriate government authorities are required where Renminbi is to be converted into foreign currency and remitted out of China to pay capital expenses such as the repayment of loans denominated in foreign currencies. The PRC government may also at its discretion restrict access in the future to foreign currencies for current account transactions. Since 2015, in response to China’s declining foreign currency reserves, the PRC government has placed increasingly stringent restrictions on the convertibility of Renminbi into foreign currencies. If the foreign exchange control system prevents us from obtaining sufficient foreign currencies to satisfy our foreign currency demands, we may not be able to pay dividends in foreign currencies to our Shareholders. Further, there can be no assurance that new regulations will not be promulgated in the future that would have the effect of further restricting the remittance of Renminbi into or out of China.

RISK FACTORS

The political relationships between China and other countries may affect our business operations.

As of the Latest Practicable Date, we had developed a global footprint in Asia Pacific, Europe, Middle East, Africa and Latin America. Our business is subject to constantly changing international economic, regulatory, social and political conditions, and local conditions in relevant foreign countries and regions. Tensions and political concerns between China and the relevant foreign countries or regions may adversely affect the macroeconomic conditions of the PRC which may in turn have a material adverse impact on our business, financial condition, results of operations, cash flows and prospects. China’s political relationships with foreign countries and regions may also affect the prospects of our relationship with third parties. There can be no assurance that our existing or potential distributors or other collaboration partners will not alter their perception of us or their preferences as a result of adverse changes to the state of political relationships between China and the relevant foreign countries or regions.

RISKS RELATING TO THE [REDACTED]

No public market currently exists for our H Shares, and an active trading market for our H Shares may not develop and the market price for our H Shares may decline or become volatile.

No public market currently exists for our H Shares. The initial [REDACTED] for our H Shares to the public will be the result of negotiations between our Company and [REDACTED] (on behalf of the [REDACTED]), and the [REDACTED] may differ significantly from the market price of the H Shares following the [REDACTED]. We have applied to the Hong Kong Stock Exchange for the [REDACTED] of, and permission to deal in, the H Shares. A [REDACTED] on the Hong Kong Stock Exchange, however, does not guarantee that an active and liquid trading market for our H Shares will develop, or if it does develop, that it will be sustained following the [REDACTED], or that the market price of the H Shares will rise following the [REDACTED].

The price and trading volume of our H Shares may be volatile, which could lead to substantial losses to investors.

The price and trading volume of our H Shares may be subject to significant volatility in response to various factors beyond our control, including the general market conditions of the securities in Hong Kong and elsewhere in the world. In particular, the business and performance and the market price of the shares of other companies engaging in similar business may affect the price and trading volume of our H Shares. In addition to market and industry factors, the price and trading volume of our H Shares may be highly volatile for specific business reasons, such as the results of clinical trials of our product candidates, the results of our applications for approval of our product candidates, regulatory developments affecting our industry, healthcare, health insurance and other related matters, fluctuations in our revenue, earnings, cash flows, investments and expenditures, relationships with our suppliers, movements or activities of key personnel, or actions taken by competitors. Moreover, shares

RISK FACTORS

of other companies listed on the Hong Kong Stock Exchange with significant operations and assets in China have experienced price volatility in the past, and our H Shares may be subject to changes in price not directly related to our performance.

There will be a gap of several days between pricing and trading of our H Shares, and the price of our H Shares when trading begins could be lower than the [REDACTED].

The initial price to the public of our H Shares sold in the [REDACTED] is expected to be determined on the [REDACTED]. However, the H Shares will not commence trading on the Hong Kong Stock Exchange until they are delivered, which is expected to be not more than five Business Days after the [REDACTED]. As a result, [REDACTED] may not be able to sell or otherwise deal in the H Shares during that period. Accordingly, holders of our H Shares are subject to the risk that the price of the H Shares when trading begins could be lower than the [REDACTED] as a result of adverse market conditions or other adverse developments that may occur between the time of sale and the time trading begins.

Future sales or perceived sales of a substantial number of our H Shares in the public market following the [REDACTED] could materially and adversely affect the price of our H Shares and our ability to raise additional capital in the future, and may result in dilution of your shareholding.

Prior to the [REDACTED], there has not been a public market for our H Shares. Future sales or perceived sales by our existing Shareholders of our H Shares after the [REDACTED] could result in a significant decrease in the prevailing market price of our H Shares. Only a limited number of the Shares currently outstanding will be available for sale or issuance immediately after the [REDACTED] due to contractual and regulatory restrictions on disposal and new issuance. Nevertheless, after these restrictions lapse or if they are waived, future sales of significant amounts of our H Shares in the public market or the perception that these sales may occur could significantly decrease the prevailing market price of our H Shares and our ability to raise equity capital in the future.

In addition, our Shareholders would experience dilution in their shareholdings upon offer or sale of additional share capital or share capital-linked securities by our Company in future offerings. If additional funds are raised through our issuance of new share capital or share capital-linked securities other than on a pro rata basis to existing Shareholders, the shareholdings of such Shareholders may be reduced and such new securities may confer rights and privileges that take priority over those conferred by the [REDACTED].

According to the stipulations by the State Council’s securities regulatory authority and the Articles of Association, our Domestic Shares may be converted into H Shares and such converted H Shares may be listed or traded on an overseas stock exchange, provided that prior to the conversion and trading of such converted shares, the requisite internal approval processes (but without the necessity of Shareholders’ approval by class) have been duly completed and the approval from the relevant PRC regulatory authorities, including the China Securities Regulatory Commission (the “CSRC”), have been obtained. In addition, such

RISK FACTORS

conversion, trading and listing must comply with the regulations prescribed by the State Council’s securities regulatory authorities and the regulations, requirements and procedures prescribed by the relevant overseas stock exchange. We can apply for the [REDACTED] of all or any portion of our Domestic Shares on the Hong Kong Stock Exchange as H Shares in advance of any proposed conversion to ensure that the conversion process can be completed promptly upon notice to the Hong Kong Stock Exchange and delivery of shares for entry on the [REDACTED]. This could increase the supply of H Shares in the market, and future sales, or perceived sales, of the converted Shares may adversely affect the trading price of H Shares.

In addition, our Unlisted Foreign Shares may be converted into H Shares subject to regulatory approvals and compliance with relevant regulatory requirements. Any conversion of our Unlisted Foreign Shares will increase the number of H Shares available on the market and may affect the trading price of our H Shares.

As the [REDACTED] of our [REDACTED] is higher than our net tangible book value per share, purchasers of our H Shares in the [REDACTED] may experience immediate dilution upon such purchases. Purchasers of H Shares may also experience further dilution in shareholdings if we issue additional Shares in the future.

The [REDACTED] of the [REDACTED] is higher than the net tangible asset value per Share immediately prior to the [REDACTED]. Therefore, purchasers of the [REDACTED] in the [REDACTED] will experience an immediate dilution in [REDACTED], and our existing Shareholders will receive an increase in the [REDACTED] per Share of their Shares. In order to expand our business, we may consider offering and issuing additional Shares in the future. Purchasers of the [REDACTED] may experience dilution in the net tangible asset value per share of their Shares if we issue additional Shares in the future at a price that is lower than the net tangible asset value per Share at that time.

Our Single Largest Group of Shareholders have had and will continue to have substantial influence over the outcome of shareholder actions in our Company.

The interests of our Single Largest Group of Shareholders may not be aligned with the interests of our other Shareholders. Dr. Zheng, directly and through Hangzhou Yantai and Hangzhou Hengtai, controls approximately 34.17% of our total issued share capital as of the Latest Practicable Date, constituting 34.17% of the aggregate voting power. Upon completion of the [REDACTED] and assuming the [REDACTED] is not exercised, Dr. Zheng will, directly and through Hangzhou Yantai and Hangzhou Hengtai, control [REDACTED]% of our total issued and outstanding Shares constituting [REDACTED]% of our aggregate voting power. As a result, our Single Largest Group of Shareholders will have significant influence over our business, including decisions regarding mergers, consolidations, liquidations and the sale of all or substantially all of our assets, election of directors and other significant corporate actions, and may take actions that are not in the best interest of us or our other Shareholders. This concentration of ownership may discourage, delay or prevent a change in control of our company, which could have the effect of depriving our other Shareholders of

RISK FACTORS

the opportunity to receive a premium for their shares as part of a sale of our company and may reduce the price of the Shares. This concentrated control will limit your ability to influence corporate matters and could discourage others from pursuing any potential merger, takeover or other change of control transactions that other holders of our ordinary shares may view as beneficial.

Because we do not expect to pay dividends in the foreseeable future after the [REDACTED], you must rely on price appreciation of our H Shares for a return on your [REDACTED].

We intend to retain most, if not all, of our available funds and any future earnings after the [REDACTED] to fund the development and commercialization of our pipeline product candidates. As a result, we do not expect to pay any cash dividends in the foreseeable future. Therefore, you should not rely on an [REDACTED] in our Shares as a source for any future dividend income.

Our Board has complete discretion as to whether to distribute dividends. Even if our Board declares and pays dividends, the timing, amount and form of future dividends, if any, will depend on our future results of operations and cash flow, our capital requirements and surplus, the amount of distributions (if any) received by us from our subsidiary, our financial condition, contractual restrictions and other factors deemed relevant by our Board. Accordingly, the return on your [REDACTED] in our H Shares will likely depend entirely upon any future price appreciation of our H Shares. There is no guarantee that our H Shares will appreciate in value after the [REDACTED] or even maintain the price at which you purchased the Shares. You may not realize a return on your [REDACTED] in our H Shares and you may even lose your entire [REDACTED] in our H Shares.

We have significant discretion as to how we will use the net [REDACTED] of the [REDACTED], and you may not necessarily agree with how we use them.

Our management may spend the net [REDACTED] from the [REDACTED] in ways with which you may not agree or which do not yield a favorable return to our shareholders. We plan to use the net [REDACTED] from the [REDACTED] to fund the pre-clinical studies, clinical trials, manufacturing and commercialization of our product and product candidates. For details, see “Future Plans and Use of [REDACTED]—Use of [REDACTED].”

However, our management will have discretion as to the actual application of our net [REDACTED]. You are entrusting your funds to our management, whose judgment you must depend on, for the specific uses we will make of the net [REDACTED] from this [REDACTED].

RISK FACTORS

Facts, forecasts and statistics in this Document relating to the diabetes management medical devices industry may not be fully reliable.

Facts, forecasts and statistics in this Document relating to the diabetes management medical devices industry in and outside China are obtained from various sources that we believe are reliable, including official government publications as well as a report prepared by CIC that we commissioned. However, we cannot guarantee the quality or reliability of these sources. Neither we, the [REDACTED], the Joint Sponsors, the [REDACTED] nor our or their respective affiliates or advisers have verified the facts, forecasts and statistics nor ascertained the underlying economic assumptions relied upon in those facts, forecasts and statistics obtained from these sources. Due to possibly flawed or ineffective collection methods or discrepancies between published information and factual information and other problems, the industry statistics in this Document may be inaccurate and you should not place undue reliance on it. We make no representation as to the accuracy of such facts, forecasts and statistics obtained from various sources. Moreover, these facts, forecasts and statistics involve risk and uncertainties and are subject to change based on various factors and should not be unduly relied upon.

You should read the entire document carefully, and we strongly caution you not to place any reliance on any information contained in press articles or other media regarding us or the [REDACTED].

Subsequent to the date of this Document but prior to the completion of the [REDACTED], there may be press and media coverage regarding us and the [REDACTED], which may contain, among other things, certain financial information, projections, valuations and other forward-looking information about us and the [REDACTED]. We have not authorized the disclosure of any such information in the press or media and do not accept responsibility for the accuracy or completeness of such press articles or other media coverage. We make no representation as to the appropriateness, accuracy, completeness or reliability of any of the projections, valuations or other forward-looking information about us. To the extent such statements are inconsistent with, or conflict with, the information contained in this Document, we disclaim responsibility for them. Accordingly, prospective [REDACTED] are cautioned to make their [REDACTED] decisions on the basis of the information contained in this Document only and should not rely on any other information.

INFORMATION ABOUT THIS DOCUMENT AND THE [REDACTED]

[REDACTED]

INFORMATION ABOUT THIS DOCUMENT AND THE [REDACTED]

[REDACTED]

INFORMATION ABOUT THIS DOCUMENT AND THE [REDACTED]

[REDACTED]

INFORMATION ABOUT THIS DOCUMENT AND THE [REDACTED]

[REDACTED]

INFORMATION ABOUT THIS DOCUMENT AND THE [REDACTED]

[REDACTED]

**WAIVERS FROM STRICT COMPLIANCE WITH THE LISTING RULES
AND EXEMPTION FROM STRICT COMPLIANCE WITH THE COMPANIES
(WINDING UP AND MISCELLANEOUS PROVISIONS) ORDINANCE**

In preparation for the [REDACTED], we have sought the following waivers and exemption from strict compliance with the relevant provisions of the Listing Rules and the Companies (Winding Up and Miscellaneous Provisions) Ordinance:

WAIVER IN RESPECT OF MANAGEMENT PRESENCE IN HONG KONG

Pursuant to Rule 8.12 of the Listing Rules, our Company must have a sufficient management presence in Hong Kong. This normally means that at least two of our executive Directors must be ordinarily resident in Hong Kong. Rule 19A.15 of the Listing Rules further provides that the requirement in Rule 8.12 of the Listing Rules may be waived by having regard to, among other considerations, our arrangements for maintaining regular communication with the Hong Kong Stock Exchange, including but not limited to compliance by us with Rules 19A.05 to 19A.07 of the Listing Rules.

Our headquarters are based, and most of the business operations of our Company and our subsidiary are managed and conducted in the PRC. Our executive Directors ordinarily reside in the PRC and they play very important roles in our Company’s business operations, it is in our best interests for them to be based in places where our Group has significant operations. We consider it practically difficult and commercially unreasonable for us to arrange for two executive Directors to be ordinarily resident in Hong Kong, either by means of relocation of existing our executive Directors or appointment of additional executive Directors. Therefore, our Company does not have, and does not contemplate in the foreseeable future that we will have sufficient management presence in Hong Kong for the purpose of satisfying the requirements under Rule 8.12 of the Listing Rules.

Accordingly, pursuant to Rule 19A.15 of the Listing Rules, we [have applied] to the Hong Kong Stock Exchange for, and the Hong Kong Stock Exchange [has granted] us, a waiver from strict compliance with Rule 8.12 and Rule 19A.15 of the Listing Rules subject to the following conditions:

1. We have appointed Dr. Zheng and Mr. Zhang Mengchi as our authorized representatives (“**Authorized Representatives**”) pursuant to Rules 3.05 and 19A.07 of the Listing Rules. The Authorized Representatives will act as our Company’s principal channel of communication with the Hong Kong Stock Exchange. The Authorized Representatives will be readily contactable by phone and email to promptly deal with enquiries from the Hong Kong Stock Exchange, and will also be available to meet with the Hong Kong Stock Exchange to discuss any matter within a reasonable period of time upon request of the Hong Kong Stock Exchange;

**WAIVERS FROM STRICT COMPLIANCE WITH THE LISTING RULES
AND EXEMPTION FROM STRICT COMPLIANCE WITH THE COMPANIES
(WINDING UP AND MISCELLANEOUS PROVISIONS) ORDINANCE**

2. When the Hong Kong Stock Exchange wishes to contact our Directors on any matter, each of the Authorized Representatives will have all necessary means to contact all of our Directors (including our independent non-executive Directors) and senior management team promptly at all times. Our Company will also inform the Hong Kong Stock Exchange promptly in respect of any changes in the authorized representatives. We have provided the Hong Kong Stock Exchange with the contact details (i.e. mobile phone number, office phone number, fax number and email address) of all Directors to facilitate communication with the Hong Kong Stock Exchange;
3. All Directors who do not ordinarily reside in Hong Kong possess or can apply for valid travel documents to visit Hong Kong and can meet with the Hong Kong Stock Exchange within a reasonable period;
4. We have appointed Orient Capital (Hong Kong) Limited as our compliance advisor (the “**Compliance Advisor**”) upon [REDACTED] pursuant to Rule 3A.19 of the Listing Rules for a period commencing on the [REDACTED] and ending on the date on which we comply with Rule 13.46 of the Listing Rules in respect of our financial results for the first full financial year commencing after the [REDACTED]. The Compliance Advisor will have access at all times to our Authorized Representatives, our Directors and our senior management as prescribed by Rule 19A.05(2) of the Listing Rules, who will act as the additional channel of communication with the Hong Kong Stock Exchange when the Authorized Representatives are not available; and
5. We have provided the Hong Kong Stock Exchange with the names, mobile phone numbers, office phone numbers, fax numbers and email addresses of at least two of the Compliance Advisor’s officers who will act as our Compliance Advisor’s contact persons between the Hong Kong Stock Exchange and our Company pursuant to Rule 19A.06(4) of the Listing Rules.

WAIVER IN RESPECT OF APPOINTMENT OF JOINT COMPANY SECRETARY

Pursuant to Rules 3.28 and 8.17 of the Listing Rules, we must appoint a company secretary who, by virtue of his/her academic or professional qualifications or relevant experience, is, in the opinion of the Hong Kong Stock Exchange, capable of discharging the functions of the company secretary. Note 1 to Rule 3.28 of the Listing Rules provides that the Hong Kong Stock Exchange considers the following academic or professional qualifications to be acceptable:

- (a) a member of The Hong Kong Institute of Chartered Secretaries;
- (b) a solicitor or barrister as defined in the Legal Practitioners Ordinance (Chapter 159 of the Laws of Hong Kong); and

**WAIVERS FROM STRICT COMPLIANCE WITH THE LISTING RULES
AND EXEMPTION FROM STRICT COMPLIANCE WITH THE COMPANIES
(WINDING UP AND MISCELLANEOUS PROVISIONS) ORDINANCE**

- (c) a certified public accountant as defined in the Professional Accountants Ordinance (Chapter 50 of the Laws of Hong Kong).

Note 2 to Rule 3.28 of the Listing Rules further provides that the Hong Kong Stock Exchange considers the following factors in assessing the “relevant experience” of the individual:

- (a) length of employment with the issuer and other issuers and the roles he/she played;
- (b) familiarity with the Listing Rules and other relevant laws and regulations including the SFO, the Companies Ordinance, the Companies (Winding Up and Miscellaneous Provisions) Ordinance and the Takeovers Code;
- (c) relevant training taken and/or to be taken in addition to the minimum requirement under Rule 3.29 of the Listing Rules; and
- (d) professional qualifications in other jurisdictions.

Our Company has appointed Mr. Duo Bo (“**Mr. Duo**”) as one of our joint company secretaries. He has extensive experience in the compliance and securities matters in the PRC but presently does not possess any of the qualifications under Rules 3.28 and 8.17 of the Listing Rules, and may not be able to solely fulfill the requirements of the Listing Rules. Therefore, we have appointed Mr. Zhang Mengchi, an associate member of both the Hong Kong Institute of Chartered Secretaries and the Chartered Governance Institute in the United Kingdom, who fully meets the requirements stipulated under Rules 3.28 and 8.17 of the Listing Rules to act as the other joint company secretary and to provide assistance to Mr. Duo for an initial period of three years from the [REDACTED] to enable Mr. Duo to acquire the “relevant experience” under Note 2 to Rule 3.28 of the Listing Rules so as to fully comply with the requirements set forth under Rules 3.28 and 8.17 of the Listing Rules.

Since Mr. Duo does not possess the formal qualifications required of a company secretary under Rule 3.28 of the Listing Rules, we [have applied] to the Hong Kong Stock Exchange for, and the Hong Kong Stock Exchange [has granted], a waiver from strict compliance with the requirements under Rules 3.28 and 8.17 of the Listing Rules such that Mr. Duo may be appointed as a joint company secretary of our Company. Pursuant to the Guidance Letter HKEX-GL108-20, the waiver will be for a fixed period of time (“**Waiver Period**”) and on the following conditions: (i) the proposed company secretary must be assisted by a person who possesses the qualifications or experience as required under Rule 3.28 (“**Qualified Person**”) and is appointed as a joint company secretary throughout the Waiver Period; and (ii) the waiver can be revoked if there are material breaches of the Listing Rules by the issuer. The waiver is valid for an initial period of three years from the [REDACTED], and is granted on the condition that Mr. Zhang Mengchi will work closely with Mr. Duo to jointly discharge the duties and responsibilities as company secretary and assist Mr. Duo in acquiring the relevant experience as required under Rules 3.28 and 8.17 of the Listing Rules. Mr. Zhang Mengchi will

**WAIVERS FROM STRICT COMPLIANCE WITH THE LISTING RULES
AND EXEMPTION FROM STRICT COMPLIANCE WITH THE COMPANIES
(WINDING UP AND MISCELLANEOUS PROVISIONS) ORDINANCE**

also assist Mr. Duo in organizing Board meetings and Shareholders’ meetings of our Company as well as other matters of our Company which are incidental to the duties of a company secretary. Mr. Zhang Mengchi is expected to work closely with Mr. Duo and will maintain regular contact with Mr. Duo, the Directors, the Supervisors and the senior management of our Company. The waiver will be revoked immediately if Mr. Zhang Mengchi ceases to provide assistance to Mr. Duo as a joint company secretary for the three-year period after the [REDACTED] or where there are material breaches of the Listing Rules by our Company. In addition, Mr. Duo will comply with the annual professional training requirement under Rule 3.29 of the Listing Rules and will enhance his knowledge of the Listing Rules during the three-year period from the [REDACTED]. Mr. Duo will also be assisted by (a) Compliance Advisor of our Company, particularly in relation to compliance with the Listing Rules; and (b) the Hong Kong legal advisors of our Company, on matters concerning our Company’s ongoing compliance with the Listing Rules and the applicable laws and regulations.

Before the expiration of the initial three-year period, the qualifications of Mr. Duo will be re-evaluated to determine whether the requirements as stipulated in Rules 3.28 and 8.17 of the Listing Rules can be satisfied and whether the need for ongoing assistance will continue. We will liaise with the Hong Kong Stock Exchange to enable it to assess whether Mr. Duo, having benefited from the assistance of Mr. Zhang Mengchi for the preceding three years, will have acquired the skills necessary to carry out the duties of company secretary and the relevant experience within the meaning of Note 2 to Rule 3.28 of the Listing Rules so that a further waiver will not be necessary.

**EXEMPTION FROM COMPLIANCE WITH SECTION 342(1) OF THE COMPANIES
(WINDING UP AND MISCELLANEOUS PROVISIONS) ORDINANCE AND
PARAGRAPH 27 OF PART I AND PARAGRAPH 31 OF PART II OF THE THIRD
SCHEDULE TO THE COMPANIES (WINDING UP AND MISCELLANEOUS
PROVISIONS) ORDINANCE**

Section 342(1)(b) of the Companies (Winding Up and Miscellaneous Provisions) Ordinance requires all documents to include matters specified in Part I of the Third Schedule to the Companies (Winding Up and Miscellaneous Provisions) Ordinance (the “**Third Schedule**”), and set out the reports specified in Part II of the Third Schedule.

Paragraph 27 of Part I of the Third Schedule requires a company to include in its document a statement as to the gross trading income or sales turnover (as the case may be) of the company during each of the three financial years immediately preceding the issue of the document, including an explanation of the method used for the computation of such income or turnover and a reasonable breakdown between the more important trading activities.

**WAIVERS FROM STRICT COMPLIANCE WITH THE LISTING RULES
AND EXEMPTION FROM STRICT COMPLIANCE WITH THE COMPANIES
(WINDING UP AND MISCELLANEOUS PROVISIONS) ORDINANCE**

Paragraph 31 of Part II of the Third Schedule further requires a company to include in its document a report by the auditors of the company with respect to (i) the profits and losses of the company for each of three financial years immediately preceding the issue of the document and (ii) the assets and liabilities of the company of each of the three financial years immediately preceding the issue of the document.

Section 342A(1) of the Companies (Winding Up and Miscellaneous Provisions) Ordinance provides that the SFC may issue, subject to such conditions (if any) as the SFC thinks fit, a certificate of exemption from the compliance with the relevant requirements under the Companies (Winding Up and Miscellaneous Provisions) Ordinance if, having regard to the circumstances, the SFC considers that the exemption will not prejudice the interest of the [REDACTED] public and compliance with any or all of such requirements would be irrelevant or unduly burdensome, or would otherwise be unnecessary or inappropriate.

Rule 4.04(1) of the Listing Rules requires that the consolidated results of the issuer and its subsidiaries in respect of each of the three financial years immediately preceding the issue of the [REDACTED] document be included in the accountants’ report to its document.

Our Company is a Biotech Company as defined under Chapter 18A of the Listing Rules and is seeking a [REDACTED] under Chapter 18A of the Listing Rules. Rule 18A.03(3) of the Listing Rules requires that a Biotech Company must have been in operation in its current line of business for at least two financial years prior to [REDACTED] under substantially the same management. Rule 18A.06 of the Listing Rules requires that a Biotech Company must comply with Rule 4.04 of the Listing Rules modified so that references to “three financial years” or “three years” in Rule 4.04 shall instead be references to “two financial years” or “two years”, as the case may be. Further, pursuant to Rule 8.06 of the Listing Rules, the latest financial period reported on by the reporting accountants for a new applicant must not have ended more than six months from the date of the [REDACTED] document.

In compliance with the abovementioned requirements under the Listing Rules, the accountants’ report of our Company set out in Appendix I to this Document is currently prepared to cover the two financial years ended December 31, 2019 and 2020.

As such, the Joint Sponsors [have applied], on behalf of our Company, to the SFC for a certificate of exemption from strict compliance with section 342(1)(b) of the Companies (Winding Up and Miscellaneous Provisions) Ordinance in relation to the requirements of paragraph 27 of Part I and paragraph 31 of Part II of the Third Schedule regarding the inclusion of the accountants’ report covering the full three financial years immediately preceding the issue of this Document on the following grounds:

**WAIVERS FROM STRICT COMPLIANCE WITH THE LISTING RULES
AND EXEMPTION FROM STRICT COMPLIANCE WITH THE COMPANIES
(WINDING UP AND MISCELLANEOUS PROVISIONS) ORDINANCE**

- (a) our Company is primarily engaged in the discovery, development, manufacturing and commercialization of biotech products, and falls within the scope of Biotech Company as defined under Chapter 18A of the Listing Rules. Our Company will fulfill the additional conditions for [REDACTED] required under Chapter 18A of the Listing Rules;
- (b) as of the Latest Practicable Date, we had generated limited revenue from product sales. Major financing activities conducted by the Company since its incorporation include the [REDACTED] Investments, the details of which have been fully disclosed in the section headed “History, Development and Corporate Structure—Establishment and Development of Our Company—(2) [REDACTED] Investments and Major Shareholding Changes of Our Company” in this Document;
- (c) given that our Company is only required to disclose its financial results for each of the two financial years ended December 31, 2019 and 2020 under Chapter 18A of the Listing Rules and preparation of the financial results for the year ended December 31, 2018 would require additional work to be performed by our Company and our auditors, strict compliance with section 342(1)(b) of the Companies (Winding Up and Miscellaneous Provisions) Ordinance in relation to the requirements of paragraph 27 of Part I and paragraph 31 of Part II of the Third Schedule would be unduly burdensome for our Company;
- (d) notwithstanding that the financial results set out in this Document are only for the two financial years ended December 31, 2019 and 2020 in accordance with Chapter 18A of the Listing Rules, other information required to be disclosed under the Listing Rules and the Companies (Winding Up and Miscellaneous Provisions) Ordinance has been adequately disclosed in this Document pursuant to the relevant requirements; and
- (e) the accountants’ report covering the two financial years ended December 31, 2019 and 2020 (as set out in Appendix I to this Document), together with other disclosures in this Document, have already provided adequate and reasonable up-to-date information in the circumstances for the potential [REDACTED] to make an informed assessment of the business, assets and liabilities, financial position, management and prospects and to form a view on the track record of our Company. Therefore, the exemption would not prejudice the interest of the [REDACTED] public.

The SFC [has granted] a certificate of exemption under section 342A of the Companies (Winding Up and Miscellaneous Provisions) Ordinance exempting our Company from strict compliance with section 342(1)(b) in relation to paragraph 27 of Part I and paragraph 31 of Part II of the Third Schedule on the condition that particulars of the exemption are set out in this Document and that this Document will be issued on or before [REDACTED].

**WAIVERS FROM STRICT COMPLIANCE WITH THE LISTING RULES
AND EXEMPTION FROM STRICT COMPLIANCE WITH THE COMPANIES
(WINDING UP AND MISCELLANEOUS PROVISIONS) ORDINANCE**

[REDACTED]

**WAIVERS FROM STRICT COMPLIANCE WITH THE LISTING RULES
AND EXEMPTION FROM STRICT COMPLIANCE WITH THE COMPANIES
(WINDING UP AND MISCELLANEOUS PROVISIONS) ORDINANCE**

[REDACTED]

DIRECTORS, SUPERVISORS AND PARTIES INVOLVED IN THE [REDACTED]

DIRECTORS

Name	Address	Nationality
-------------	----------------	--------------------

Executive Directors

Dr. Zheng Pan (鄭攀)	No. 31, Qilin Street Xiacheng District Hangzhou, China	Chinese
-----------------------	--	---------

Dr. Yu Fei (于非)	Room 1001, Door 4, Floor 6 No. 108 Courtyard Majiapu East Road Fengtai District Beijing, China	Chinese
--------------------	--	---------

Ms. Liu Xiu (劉秀)	Room 301, Unit 3, Block 24 Fuyuan Xincun No.1 Zijinghua Road Xihu District Hangzhou, China	Chinese
---------------------	--	---------

Ms. Xu Fangling (徐方玲)	Room 201, No. 7 Chenxin Lane Jiangcheng Road Shangcheng District Hangzhou, China	Chinese
--------------------------	---	---------

Non-Executive Directors

Mr. Hu Xubo (胡旭波)	No. 28, Alley 88 Zizhu Road Jinqiao Town Pudong New District Shanghai, China	Chinese
----------------------	--	---------

Ms. Gao Yun (高韻)	Room 3006, Block 2 No. 547, Tianmu West Road Jing'an District Shanghai, China	Chinese
---------------------	--	---------

DIRECTORS, SUPERVISORS AND PARTIES INVOLVED IN THE [REDACTED]

Independent Non-Executive Directors

Dr. Li Lihua (厲力華)	Room 2601, Unit 6, Block 1 Taiyang International Apartment No. 730 Weiye Road Binjiang District Hangzhou, China	American
Ms. Gao Jian (高健)	Room 2601, 5-1 Shuiyin City Binsheng Road Binjiang District Hangzhou, China	Chinese
Ms. Wang Chunfeng (王春鳳)	Room 2101, 1-2 Qixia Ju Jindi Zizai City Xihu District Hangzhou, China	Chinese
Mr. Ho Kin Cheong Kelvin (何建昌)	Flat 2709 Ka Yeung House Ka Shing Court Fanling, New Territory Hong Kong, China	Chinese (Hong Kong)

SUPERVISORS

Name	Address	Nationality
Mr. Li Zhenhua (李振華)	No. 10, Group 42 Gaoqiao Village Cangqian Street Yuhang District Hangzhou, China	Chinese
Mr. Lv Cheng (呂承)	Room A2203, Block A Soho Fuxing Plaza No. 388 Madang Road Huangpu District Shanghai, China	Chinese
Mr. Zhao Zhiheng (趙志恆)	Room 301, No. 39, Shisanwan Alley Shangcheng District Hangzhou, China	Chinese

For details with respect to our Directors and Supervisors, see “Directors, Supervisors and Senior Management.”

DIRECTORS, SUPERVISORS AND PARTIES INVOLVED IN THE [REDACTED]

PARTIES INVOLVED IN THE [REDACTED]

Joint Sponsors

Goldman Sachs (Asia) L.L.C.

68/F, Cheung Kong Center
2 Queen's Road Central
Hong Kong

China International Capital Corporation

Hong Kong Securities Limited

29/F, One International Finance Center
1 Harbour View Street, Central
Hong Kong

[REDACTED]

DIRECTORS, SUPERVISORS AND PARTIES INVOLVED IN THE [REDACTED]

[REDACTED]

Legal Advisors to our Company

As to Hong Kong law and United States law

Davis Polk & Wardwell

18th Floor
The Hong Kong Club Building
3A Chater Road
Hong Kong

As to PRC law

Llinks Law Offices

19F, One Lujiazui 68
Yin Cheng Road Middle
Shanghai, China

**Legal Advisors to the Joint Sponsors
and the [REDACTED]**

As to Hong Kong law and United States law

Clifford Chance

27/F, Jardine House
One Connaught Place
Hong Kong

As to PRC law

Tian Yuan Law Firm

Room 4403-4406, Jinmao Tower
88 Century Avenue
Pudong District
Shanghai, China

DIRECTORS, SUPERVISORS AND PARTIES INVOLVED IN THE [REDACTED]

**Reporting Accountants
and Independent Auditor**

Ernst & Young
Certified Public Accountants
Registered Public Interest Entity Auditor
22/F, CITIC Tower
1 Tim Mei Avenue
Central, Hong Kong

Industry Consultant

**China Insights Industry Consultancy
Limited**
10F, Block B
Jing’an International Center
88 Puji Road, Jing’an District
Shanghai, China

[REDACTED]

CORPORATE INFORMATION

Registered Office	No. 108 Liuze Street Cangqian Street Yuhang District, Hangzhou Zhejiang, China
Headquarters and Principal Place of Business in the PRC	No. 108 Liuze Street Cangqian Street Yuhang District, Hangzhou Zhejiang, China
Principal Place of Business in Hong Kong	[40/F, Dah Sing Financial Centre No. 248 Queen’s Road East Wanchai Hong Kong, China]
Company’s Website	<u>www.microtechmd.com</u> <i>(The information contained in this website does not form part of this Document)</i>
Joint Company Secretaries	Mr. Duo Bo (朵波) No. 108 Liuze Street Cangqian Street Yuhang District, Hangzhou Zhejiang, China Mr. Zhang Mengchi (張夢弛) <i>Associate member of both the Hong Kong Institute of Chartered Secretaries and the Chartered Governance Institute in the United Kingdom</i> 40/F, Dah Sing Financial Centre No. 248 Queen’s Road East Wanchai Hong Kong, China
Authorized Representatives	Dr. Zheng Pan (鄭攀) No. 31, Qilin Street Xiacheng District Hangzhou, China Mr. Zhang Mengchi (張夢弛) 40/F, Dah Sing Financial Centre No. 248 Queen’s Road East Wanchai Hong Kong, China

CORPORATE INFORMATION

Audit Committee	Ms. Gao Jian (高健) (<i>Chairman</i>) Mr. Ho Kin Cheong Kelvin (何建昌) Ms. Gao Yun (高韻)
Remuneration and Assessment Committee	Ms. Wang Chunfeng (王春鳳) (<i>Chairman</i>) Mr. Ho Kin Cheong Kelvin (何建昌) Ms. Xu Fangling (徐方玲)
Nomination Committee	Dr. Li Lihua (厲力華) (<i>Chairman</i>) Ms. Gao Jian (高健) Dr. Zheng Pan (鄭攀)
Strategy Committee	Dr. Zheng Pan (鄭攀) (<i>Chairman</i>) Dr. Li Lihua (厲力華) Mr. Hu Xubo (胡旭波)
Compliance Advisor	Orient Capital (Hong Kong) Limited 28/F-29/F, 100 Queen’s Road Central Central Hong Kong

[REDACTED]

Principal Banks	Industrial and Commercial Bank of China Hangzhou Kechuang Branch No. 998 Wenyi West Road Yuhang District Hangzhou, China
	Agricultural Bank of China Hangzhou Xixi Branch No. 1500 Wenyi West Road Yuhang District Hangzhou, China
	Bank of China Hangzhou Chengxi Kechuang Branch Block 4, No. 998 Wenyi West Road Wuchang Street Yuhang District Hangzhou, China

INDUSTRY OVERVIEW

The information and statistics set out in this section and other sections of this Document were extracted from different official government publications, available sources from public market research and other sources from independent suppliers. In addition, we engaged China Insights Industry Consultancy Limited in preparing the CIC Report, an independent industry report in respect of the [REDACTED]. We believe that the sources of the information in this section and other sections of this Document are appropriate sources for such information, and we have taken reasonable care in extracting and reproducing such information. We have no reason to believe that such information is false or misleading or that any fact has been omitted that would render such information false or misleading. The information from official and non-official sources has not been independently verified by us, the Joint Sponsors, [REDACTED], [REDACTED], [REDACTED], any of the [REDACTED], any of their respective directors and advisers, or any other persons or parties involved in the [REDACTED] (except CIC), and no representation is given as to its accuracy. Accordingly, the information from official and non-official sources contained herein may not be accurate and should not be unduly relied upon. Our Directors confirm that, after making reasonable enquiries, there is no adverse change in the market information since the date of the CIC Report that would qualify, contradict or have a material impact on the information in this section.

DIABETES DISEASE

Overview

Diabetes is caused by the body’s inability to produce or effectively utilize the insulin, which prevents the body from adequately regulating blood glucose levels. According to the CIC Report, diabetes is one of the most prevalent chronic diseases globally with a large patient population and huge unmet clinical needs. Glucose, the primary source of energy for cells, must be maintained at certain concentrations in the blood in order to permit optimal cell function and health. In people with diabetes, blood glucose levels fluctuate between very high levels, a condition known as hyperglycemia, and very low levels, a condition called hypoglycemia. Hyperglycemia can lead to serious short-term complications, such as confusion, vomiting, dehydration and loss of consciousness; long-term complications, such as blindness, kidney disease, nervous system disease, amputations, stroke and cardiovascular disease; or death. Hypoglycemia can lead to short-term complications, such as hunger, sweating, shakiness, fatigue, weakness, and inability to think clearly, whereas severe hypoglycemia can lead to long-term complications, such as confusion, seizures, loss of consciousness or death. Many patients have difficulty managing their diabetes optimally. For example, patients attempting to control their blood glucose levels tightly to prevent the long-term complications associated with fluctuations in blood glucose levels are at greater risk for overcorrection and the resultant hypoglycemia.

INDUSTRY OVERVIEW

Types of Diabetes

There are three main types of diabetes, namely Type 1 diabetes, Type 2 diabetes and gestational diabetes. Type 1 diabetes can develop at any age but occurs most frequently in children and adolescents. When one has Type 1 diabetes, his/her body produces very little or no insulin. Type 2 diabetes is more common in adults and accounts for around 90% of all diabetes cases. When one has Type 2 diabetes, his/her body does not make good use of the insulin that it produces. Gestational diabetes is a type of diabetes that consists of high blood glucose during pregnancy and is associated with complications for both the mother and child. Gestational diabetes usually disappears after pregnancy but pregnant women are nevertheless affected, and their children are at an increased risk of developing Type 2 diabetes later in life.

Prevalence of Diabetes in China and Globally

According to IDF, China is the country with the highest number of diabetes patients in 2019. In China, the number of Type 1 diabetes patients increased from 1.3 million in 2015 to 2.4 million in 2019, at a CAGR of 17.0% and is expected to further increase to 4.6 million in 2030, at a CAGR of 6.2% from 2019 to 2030; the number of Type 2 diabetes patients was 114.2 million in 2019 and is expected to increase to 136.0 million in 2030, at a CAGR of 1.6% from 2019 to 2030. The chart below shows the prevalence of Type 1 diabetes, Type 2 diabetes and gestational diabetes in China.

Prevalence of diabetes, China, 2015-2030E

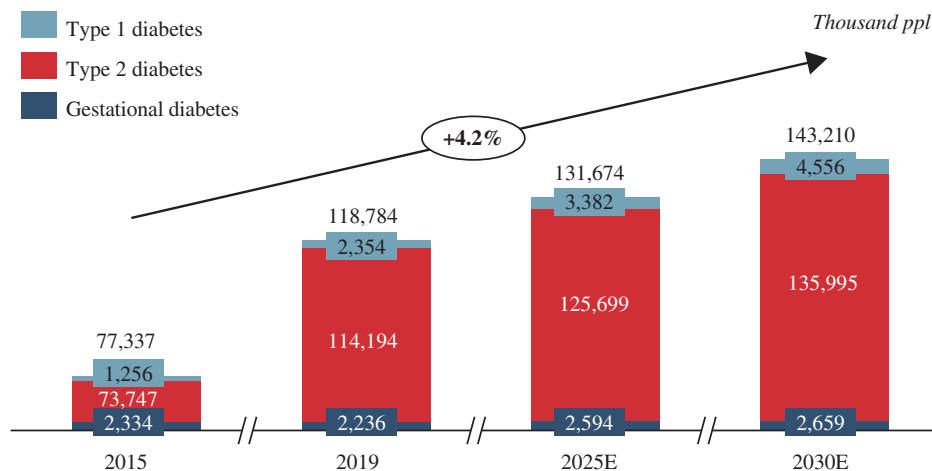

Source: CIC Report, IDF

Globally, the number of Type 1 diabetes patients increased from 16.9 million in 2015 to 20.7 million in 2019, at a CAGR of 5.2% and is expected to further increase to 26.6 million in 2030, at a CAGR of 2.3% from 2019 to 2030; the number of Type 2 diabetes patients increased from 357.9 million in 2015 to 444.1 million in 2019, at a CAGR of 5.5%, and is expected to further increase to 554.1 million in 2030, at a CAGR of 2.0% from 2019 to 2030. The chart below shows the global prevalence of Type 1 diabetes, Type 2 diabetes and gestational diabetes.

INDUSTRY OVERVIEW

Global prevalence of diabetes, 2015-2030E

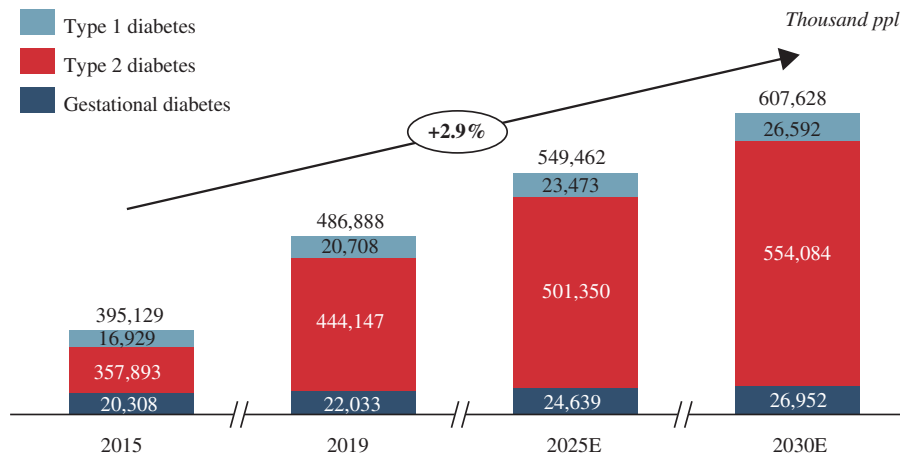

Source: CIC Report, IDF

The increasing prevalence of diabetes worldwide is largely attributable to an upsurge in Type 2 diabetes and related factors, which include among others, aging population, rising levels of obesity, unhealthy diets and widespread physical inactivity. Particularly, in China, the accelerated urbanization led to changes in people’s lifestyles, such as a significant reduction in physical activities and stressful work environment. In 2019, the medical expenditure on diabetes in China was US\$109.0 billion and the global medical expenditure on diabetes was US\$760.3 billion.

Diabetes can affect almost every part of the human body, and therefore it is important to manage diabetes effectively; when left untreated, diabetes can lead to potential complications including heart disease, stroke, kidney damage, and nerve damage, among other risks. Diabetes can be managed by using a combination of treatment and monitoring devices, typically including an insulin delivery system and a glucose monitor respectively. For Type 1 diabetes treatment, it is necessary to use insulin, and there are two types of insulin therapy, multiple daily injection (“MDI”) therapy and continuous insulin infusion (“CSII”) therapy. For Type 2 diabetes and gestational diabetes, insulin infusion treatment is also one of the major treatment methods. For all those patients, the continuous glucose monitoring is critical to avoid the risk of hyperglycemia and hypoglycemia.

DIABETES MANAGEMENT MEDICAL DEVICES MARKET

Overview of the Diabetes Management Medical Devices Market

Diabetes is managed using a combination of treatment and monitoring devices, typically including an insulin delivery system and a glucose monitor respectively. Accordingly, the diabetes management medical devices market is segmented by device type, namely into either treatment or monitoring devices. Diabetes treatment devices include insulin syringes, insulin pens and insulin pumps. Diabetes monitoring devices include blood glucose monitoring system (“BGMS”) and continuous glucose monitoring systems (“CGMS”). Artificial pancreas device, which combines the functions of both treatment and monitoring devices, is able to monitor glucose levels in the body and deliver insulin based on different glucose levels as required. The following graph illustrates how the diabetes monitoring device, diabetes treatment devices and artificial pancreas device function.

INDUSTRY OVERVIEW

Diabetes management devices

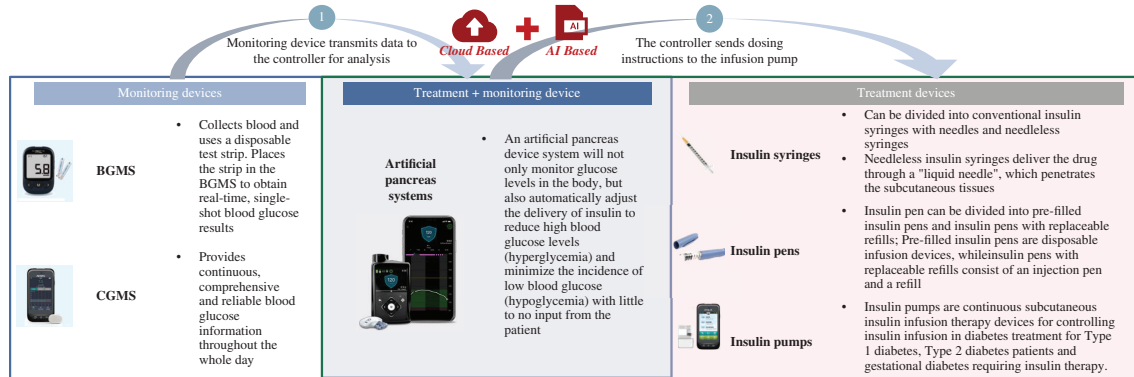

Source: CIC Report

Market Size of the Diabetes Management Medical Devices Market

The market size of the diabetes management medical devices market in China increased from US\$0.9 billion in 2015 to US\$2.4 billion in 2020, at a CAGR of 21.6%, and is expected to further increase to US\$9.5 billion in 2030, at a CAGR of 14.7% from 2020 to 2030. The market size of global diabetes management medical devices market increased from US\$33.2 billion in 2015 to US\$47.8 billion in 2020, at a CAGR of 7.6%, and is expected to further increase to US\$111.1 billion in 2030, at a CAGR of 8.8% from 2020 to 2030. The chart shows the market size of the global diabetes management medical devices market.

Global diabetes management medical devices market, 2015-2030E

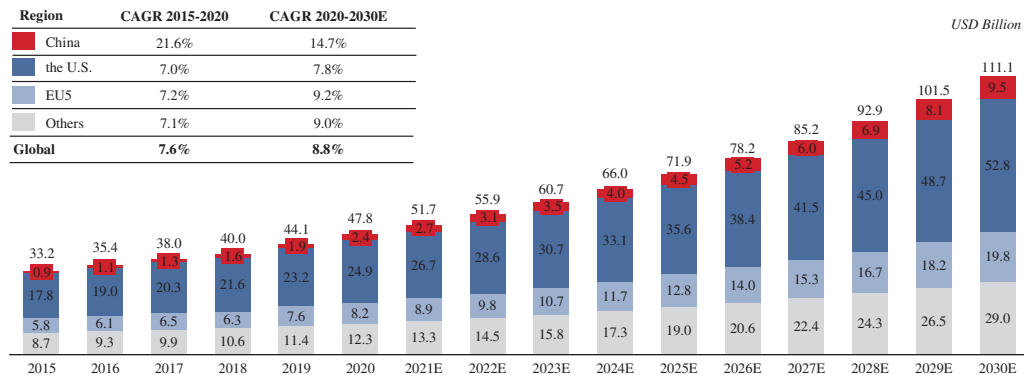

Source: CIC Report

INDUSTRY OVERVIEW

Growth Drivers of the Diabetes Management Medical Devices Market

The diabetes management medical devices market is expected to maintain its growth mainly due to the following factors:

- ***Increasing number of diabetes patients.*** The global prevalence of diabetes was 486.9 million people in 2019 and is expected to reach 607.6 million people in 2030. The prevalence of diabetes in China was 118.8 million people in 2019 and is expected to reach 143.2 million people in 2030.
- ***Increasing diabetes patient diagnosis rate.*** According to IDF statistics, approximately 40%-60% of people aged 20-79 years old with diabetes were diagnosed in 2019 globally. In another word, more than 232 million people aged 20-79 years old with diabetes were undiagnosed in 2019 globally. With rapid economic development in developing countries such as China, people’s health awareness are improving and the diagnosis rate of diabetes is expected to increase.
- ***Increasing demand for accurate continuous diabetes monitoring medical devices.*** With rapid economic development in developing countries, people’s demand for more accurate continuous diabetes monitoring medical devices, such as dynamic blood glucose monitoring, and digital management systems, such as cloud-based control functions, is projected to increase. This can greatly drive the development of the diabetes monitoring medical devices industry and increase the overall penetration rate for diabetes management.
- ***Wider usage of diabetes treatment devices.*** The strong clinical evidence increases the recognition of diabetes treatment medical devices among physicians and patients. With increasing recognition, more patients are expected to use diabetes treatment medical devices. Besides, with the benefits of reducing the patients’ blood glucose fluctuations, increasing the blood glucose compliance rate, etc., more treatment methods like short-term intensive insulin therapy using effective diabetes treatment medical devices can be used for more indications like newly diagnosed Type 2 diabetes and gestational diabetes. The innovative means of payment like insurance coverage can also boost the wider use of diabetes treatment medical devices.
- ***Favorable insurance policies and government policies for diabetes management industry.*** The development of health insurance with health management functions is the general trend, and the professional advantages of big data management of commercial health insurance will be used to promote the development of the health management industry. In 2019, the health insurance expenditure amount in the United States reached US\$2,752.8 billion. National industrial policy on medical devices and long-term planning in the area of diabetes management are expected to stimulate the rapid development of the diabetes management industry. For example, NHC issued “Promotion of the Implementation of the Healthy China Action 2020 Work Plan” in September 2020, which promotes diabetes health management code, selects pilot districts and counties to carry out diabetes health management services, focuses on groups at a high risk for diabetes, promotes the standardized management of diabetes, and improves the rate of diabetes awareness, treatment and control.

INDUSTRY OVERVIEW

Entry Barriers of the Diabetes Management Medical Devices Market

The diabetes management medical devices industry is characterized by high entry barriers, mainly including:

- **Technology.** The technical level is still the main barrier in the diabetes management devices market. Due to the technical difficulties, China’s diabetes monitoring market lacks representative CGMS, forming an obvious industry barrier. Therefore, manufacturers who can develop and produce CGMS with a high level of accuracy, high durability and calibration-free functions through technological innovations are likely to quickly build their own moat around this product offering and achieve a major first-mover advantage. In the field of medical devices for diabetes treatment, insulin pumps are the main research direction at present, and it is now the consensus of the industry to make insulin pumps more compact and portable to increase their user-friendliness. However, the overall structure of the insulin pump is complex. There is a high technical difficulty to realize the assembly of many components in a smaller device such as a patch insulin pump, which also forms an obvious industry barrier.
- **Talent.** The medical devices industry covers a wide range of disciplines and requires professionals with complex backgrounds. Medical device manufacturers need different types of talents from R&D, sales to management. Talents with composite backgrounds and rich industry experience tend to choose to work for those manufacturers with a strong market reputation, access to abundant capital, high R&D levels and advanced sales capacities. Therefore, it is difficult for new market entrants to attract talented people to join them in their initial stage of development. Medical device manufacturers that have already entered the market and have formed mature R&D teams thus have a better foundation to fend off potential competitors.
- **Manufacturing barrier.** The production of medical devices requires significant capital investment and production capacity. Due to the complex production procedures of medical devices and strict requirements on medical devices’ quality, the ability to develop technology and massively produce diabetes management medical devices will be an important entry barrier for manufactures.
- **Sales network.** The establishment of a sales network in the medical devices industry requires a long period of time and places high requirements on manufacturers in terms of their distribution capacity and level of capital reserves, which means that it is usually difficult for new entrants to establish full-scale market channels within a short period of time. Medical device sales involve a wide geographical coverage and high professional requirements in terms of sales personnel, with the corresponding investments in human, material and financial resources also running high. Hospitals and patients also have a certain degree of stickiness when it comes to certain medical device brands.

INDUSTRY OVERVIEW

- ***Strict regulatory requirements.*** The medical devices for diabetes management in China are highly regulated. For example, before a Class III medical device can be approved for commercialization in China, the manufacturer needs to conduct extensive pre-clinical studies and needs to complete clinical trials, which would take a long time to complete and would involve significant costs. In the U.S., the approval cycle for medical devices is long, and the approval period for Class II and Class III products may reach nine months. In EU, Class II and Class III approval process are generally the same, which takes three to six months. Established companies have more resources to quickly respond to, and to strictly comply with, such regulations and policies, and it may therefore be difficult for new participants in the industry to achieve the same results.

Future Trends of the Diabetes Management Medical Devices Market

With the continued development of technology, the diabetes management medical devices industry has the following trends:

- ***Integrated closed loop artificial pancreas.*** The leading development area in the diabetes management medical devices industry is that of the integrated closed loop artificial pancreas. Through integrated closed loop artificial pancreas, the glucose level can be monitored and the insulin dosage can be adjusted according to the results from CGMS. At the same time, the system shall be easy to use, convenient and discreet. With the integrated closed loop artificial pancreas, patients can manage diabetes better.
- ***Increasing demand for cost-effective and accurate continuous glucose monitoring.*** For the precise diabetes management, continuous glucose monitoring 24-7 can provide a full spectrum of patients’ glucose level, in order to help physicians to comprehend the condition of diabetic patients and to provide comprehensive diabetes treatment solutions. Based on the real-time and continuous data, diabetes management devices can provide early warning of the low and high glucose level and help to reduce the risks of hyperglycemia and hypoglycemia. Besides, with the manufacturing development and insurance coverage, the diabetes monitoring medical devices will cost less in the future, which results in a higher penetration rate among patients with diabetes.
- ***Minimal invasive or non-invasive.*** Avoid finger pricking and minimal invasive are the future trend of continuous glucose monitoring to improve patients’ compliance level. Lots of patients suffer from the finger pricking several times per day. Calibration-free CGMS measures glucose levels (typically interstitial glucose) continuously and eliminates patient’s sufferings from daily finger pricking. For the comfort and compliance purpose, the minimal invasive or even non-invasive feature is one of the goals that manufactures aim at.

INDUSTRY OVERVIEW

- Integrated diabetes management ecosystem.** With increasing data collected by monitoring devices from numbers of diabetics and pre-diabetics, integrated diabetes management ecosystem covering inside and outside hospital patient management will become an inevitable trend. Combined with AI tech, round the clock monitoring and management inside and outside hospitals can efficiently help manage the out-of-hospital market, particularly for commercial insurance companies, to reduce the incidence of diabetic complication and diabetic expenditure.

DIABETES TREATMENT MEDICAL DEVICES MARKET

Overview of the Diabetes Treatment Medical Devices Market

Insulin is one of the most widely used drugs to treat diabetes. For Type 1 diabetes treatment, it is necessary to use insulin, and there are two types of insulin therapy, MDI therapy and CSII therapy. For Type 2 diabetes and gestational diabetes, insulin infusion treatment is also one of the major treatment methods.

The chart below shows the market size of the global diabetes treatment medical device market.

Global diabetes treatment medical devices market, 2015-2030E

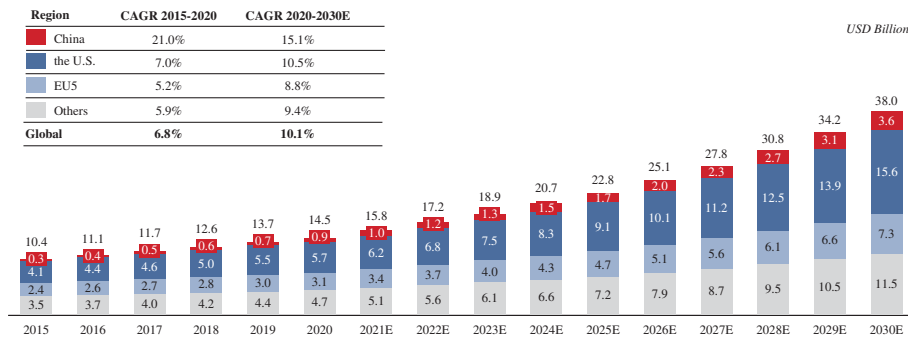

Source: CIC Report

Introduction of Insulin Infusion Devices

According to the classification of insulin delivery methods, diabetes treatment devices can be mainly divided into insulin pumps, insulin pens, insulin syringes, among others. In order to achieve blood glucose stability throughout the day, insulin pumps are gradually becoming a new generation of insulin infusion devices. The following figures illustrate the three main types of insulin infusion devices and the differences among them.

INDUSTRY OVERVIEW

Introduction and comparison of insulin infusion devices

● High → ○ Low

Infusion devices	Definition	Annual cost	Usability	Pain	Frequency	Advantages	Disadvantages
Insulin pump	<ul style="list-style-type: none"> The pump is designed to continuously infuse fluid (insulin) into a patient in a controlled manner as an aid in the management of diabetes requiring insulin infusion. The insulin pump can be connected with the CGMS to function as artificial pancreas. 	●	<ul style="list-style-type: none"> Easy to carry and use Almost no influence on lifestyle 	○	<ul style="list-style-type: none"> Consumables generally need to be changed once every 3 days 	<ul style="list-style-type: none"> Deliver insulin more accurately Deliver insulin more flexible: can be programmed to deliver different doses of insulin automatically at specific times Eliminate unpredictable effects of intermediate-or long-acting insulin With alarms 	<ul style="list-style-type: none"> Long time wear required
Insulin pen	<ul style="list-style-type: none"> The insulin pen is an insulin infusion device consisting of an insulin refill and a dial for measurement, which can be divided into reusable insulin pens after refill and disposable insulin pens with pre-filled disposable insulin refills. 	○	<ul style="list-style-type: none"> Easy to carry Easy to use 	○	<ul style="list-style-type: none"> 2-4 times per day Needles need to be changed one at a time 	<ul style="list-style-type: none"> Insulin pens can make taking insulin more convenient because they combine the medication and syringe in one handy unit Require less training and simple to perform infusion Portable and discreet: can be carried in a pocket 	<ul style="list-style-type: none"> Need to administer insulin many times a day Cannot change the basal rate If the patient inject insulin near the same place every time, hard lumps or fatty deposits can develop
Insulin syringes	<ul style="list-style-type: none"> Insulin syringes is a piston syringe, typically sterile, single-use with a needle, used for subcutaneous infusion of insulin. Moreover, Insulin needleless syringes are expected to be used to push the drug in the ampoule through the micro-hole with the power released from the spring inside the syringe to form a "liquid needle" that penetrates through the epidermal cells and into the subcutaneous tissue. 	○	<ul style="list-style-type: none"> Need for insulin extraction Easy to use 	○	<ul style="list-style-type: none"> 2-4 times per day Needles for single use and no risk of infection 	<ul style="list-style-type: none"> Two types of insulin can be mixed with a syringe 	<ul style="list-style-type: none"> Can not preload with insulin including premixed insulins If the patient inject insulin near the same place every time, hard lumps or fatty deposits can develop

Source: CIC Report

Insulin Pumps

Insulin pumps are continuous subcutaneous insulin infusion therapy devices for controlling insulin infusion in diabetes treatment for Type 1 diabetes and Type 2 diabetes patients requiring insulin therapy. Insulin pumps can be divided into tubeless patch pumps and tubed pumps. The following figures illustrate how the patch pumps and tubed pumps function.

Tubeless patch pumps

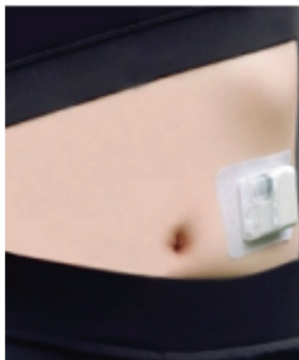

Tubed pumps



Source: Guidelines for insulin pump therapy in China, 2021 edition

INDUSTRY OVERVIEW

The following table illustrates the differences between patch pumps and tubed pumps.

Advantages of patch pump

Category	Tubeless patch pumps	Tubed pumps
Portability	<ul style="list-style-type: none"> Lighter, smaller and more discreet Tubeless 	<ul style="list-style-type: none"> Heavier, larger and less private With tubing between the pump and the cannula
Safety	<ul style="list-style-type: none"> Reduced risk of clogging of the insulin in the insulin infusion set, insulin remains at similar temperature level inside the patch pump 	<ul style="list-style-type: none"> The design of the tube may pose a risk of blockage
Compliance	<ul style="list-style-type: none"> Ease of use Simplified training with fewer steps to initiate CSII Higher patient adherence 	<ul style="list-style-type: none"> Hard to use due to the long tube Need long time training to use Poorer compliance
Expenditure	<ul style="list-style-type: none"> Due to its semi or fully disposable feature, the upfront cost is lower 	<ul style="list-style-type: none"> The upfront cost is higher

Source: CIC Report

Market Size of Insulin Pumps

Given the multiple advantages of insulin pump, it has been more widely adopted for diabetes treatment and its market share among diabetes treatment medical devices also increased. Insulin pump is currently not included under the national public medical insurance program in China. However, insulin pump is reimbursable under local governmental patient assistance program in certain cities and the inpatient treatment cost using insulin pump is included under public medical insurance program in many provinces, depending on local governmental policies, in China. Inclusion of insulin pump under the public medical insurance program in the future will promote the growth of the insulin pump market in China.

The charts below show the market size of insulin pumps globally and in China, respectively.

Global market size of insulin pumps, 2015-2030E

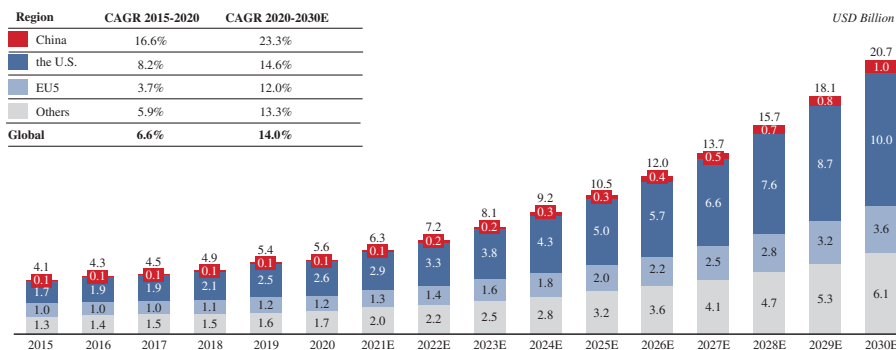

China's market size of insulin pump, 2015-2030E

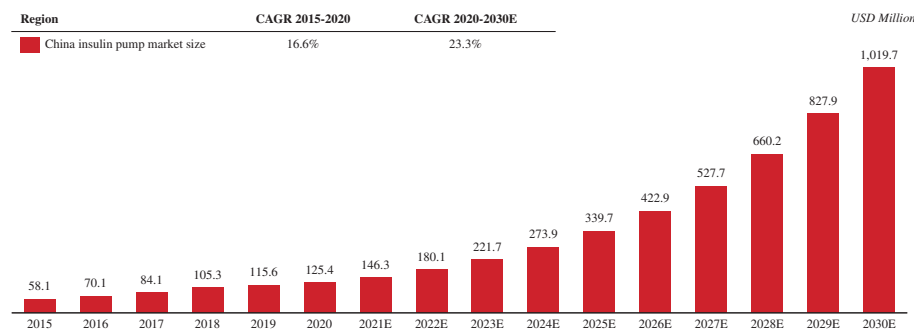

Source: CIC Report

INDUSTRY OVERVIEW

The chart below shows the market size of patch pumps and tubed pumps globally.

Global market size of insulin pumps, by type, 2015-2030E

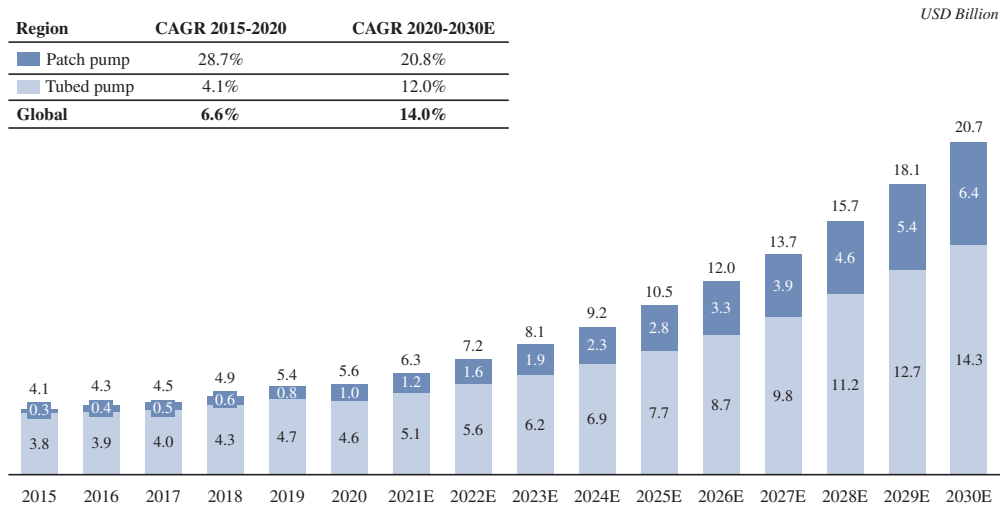

Source: CIC Report

Competitive Landscape of Insulin Pump Products

According to the CIC Report, as of the Latest Practicable Date, Equil was the first and only domestically developed patch insulin pump approved in China, which is significantly more portable and user-friendly than the traditional tubed pump. The following table sets forth the comparison of the insulin pump products by major manufacturers in China as of the Latest Practicable Date.

Insulin pump products by major manufacturers in China

Manufacturer	The Company	Medtronic	SOOIL	Fornia	Phray
Product name	Equil	MiniMed	DANA Diabecare	IP-101	Ph300
Approval time	2017.9	2011.12	2008.2	2003.10	2013.4
Applicable population	Adult with diabetes	Patients with diabetes who need to be treated with insulin infusion	Adults and children with diabetes	Patients with diabetes who need to be treated with insulin infusion	Patients with diabetes who need to be treated with insulin infusion
Type	Patch pump	Tubed pump	Tubed pump	Tubed pump	Tubed pump
Capacity of insulin reservoir	200U	300U	300U	300U	305U

Source: CIC Report

The insulin pump market is currently occupied by imported manufacturers such as Medtronic and SOOIL, while domestic manufacturers such as Fornia, Phray, Apex Medical and Microport only occupy a small portion of the market. With the first insulin pump product commercialized in 2018, the Company rapidly achieved market expansion in the fast-growing market within less than three years and had a market share of 3% in the insulin pump market in China in 2020, according to the CIC Report. As of the Latest Practicable Date, the Company’s product, Equil, was the first and only domestically developed patch insulin pump approved in China, according to the CIC Report. With the continued market expansion and upgrade of products, the Company is expected to capture the market opportunities and expand

INDUSTRY OVERVIEW

its market share in the insulin pump market to become one of the leading insulin pump manufacturers in China. The following chart illustrates the market share of top five manufacturers in terms of revenue in China’s insulin pump market in 2020.

Top five insulin pump manufactures in China’s insulin pump market, 2020

No.	Name	Product approval time	Type of marketed insulin pumps	Market share in 2020	Revenue CAGR, 2018-2020
1	Company A international brand	2011	Tubed pump	~56%	~7%
2	Company B international brand	2008	Tubed pump	~23%	~11%
3	Company C domestic brand	2003	Tubed pump	~5%	~(9%)
4	The Company	2017	Patch pump	~3%	~90%
5	Company D domestic brand	2013	Tubed pump	~3%	~8%
Total market				100%	~9%

Source: CIC Report

The following table sets forth the comparison of the insulin pump products by major manufacturers in the global market as of the Latest Practicable Date.

Insulin pump products by major manufacturers in the global market

Manufacturer	The Company	Insetlet	Roche	Medtronic	Tandem Diabetes Care
Product	Equil	Omnipod	Accu-Chek Solo	MiniMed	t:slim
Marketed regions	China, EU	The U.S., EU	EU	China, the U.S., EU	The U.S., EU
Applicable population	Adults with diabetes	Adults and children with diabetes	Adults with diabetes	Diabetic patients over 16 years old	Diabetic patients over 6 years old
Type	Patch pump	Patch pump	Patch pump	Tubed pump	Tubed pump
Duration	Several years	Three days	Four months	Several years	Several years
Weight without battery	23g	25g	29g	≤106g	112g (Equipped with rechargeable battery)
Is the pump body reusable or not	√	×	√	√	√
Capacity of insulin reservoir	200U	200U	200U	300U	300U

Source: CIC Report

INDUSTRY OVERVIEW

The following table sets for the major insulin pump products under development in the global market as of the Latest Practicable Date.

Major insulin pump products under development in the global market

Manufacturer	Product	Type	R&D progress	Product features
Medtronic	MiniMed780G	• Tubed pump	• Pending FDA approval	<ul style="list-style-type: none"> • Auto-correction every 5 mins, as needed 24/7 • Can work with Medtronic’s CGM sensor Zeus to function as artificial pancreas
Tandem	t:sport mini-pump	• Tubed pump	• Pending FDA approval	<ul style="list-style-type: none"> • Half the size of the previous generation • No display screen
Insulet	Omnipod Horizon	• Patch pump	• Pending FDA approval	<ul style="list-style-type: none"> • Can be controlled by smartphone app • Conduct automated insulin delivery • Can work with CGMS to function as artificial pancreas
BD	Patch Pump for T2	• Patch pump	• Completed clinical trials	<ul style="list-style-type: none"> • New disposable, three-day wearable tubeless pump • Provides basal and bolus dosing • Comes with reusable handheld controller and connects to smartphone app via Bluetooth

Source: CIC Report

Growth Drivers and Future Trends of Insulin Pump

The insulin pump market is expected to maintain its growth mainly due to the following factors:

- ***Increasing recognition of the clinical effects of insulin pumps.*** The up-to-date studies will further make diabetes patients realize that insulin pumps have good clinical effects and thus, patients will be willing to use insulin pumps, which drives the growth of insulin pump market. Clinical results confirmed that blood glucose controlled by insulin pumps can effectively prevent diabetic complications, and slow down existing complications. The strong clinical evidence increases the recognition of insulin pumps among physicians. Insulin pumps are included in the Guidelines for the Prevention and Treatment of Type 2 Diabetes in China (2017 Version) (《中國2型糖尿病防治指南(2017年版)》) due to wide recognition of its efficacy. With increasing recognition of insulin pumps, more patients are expected to use insulin pumps.
- ***Rising demand for insulin pump.*** With the improvement of education level, more and more patients recognize the advantages and effectiveness of insulin pumps. Together with the rising income per capita and the lower upfront cost of patch pumps, the afore-mentioned results in an increasing demand for insulin pump.
- ***Emerging wide adoption of short-term intensive insulin therapy.*** With the issuance of relevant expert guidance, along with diagnosis and treatment guidelines, short-term intensive insulin therapy has been identified as an effective treatment for diabetic patients and will gradually be promoted in hospitals. Compared with insulin injections, the use of insulin pumps can improve the effectiveness of short-term intensive therapy, since insulin pumps can maximize the physiological secretion pattern of insulin through individualized basal rates and pre-meal high-dose insulin

INDUSTRY OVERVIEW

settings, resulting in better glycemic control. Short-term intensive insulin therapy can be especially used for newly diagnosed Type 2 diabetes and gestational diabetes, as the use of insulin pumps can reduce the patients' blood glucose fluctuations, increase the blood glucose compliance rate, shorten the time required to reach the standard. With better clinical effects and patients' experience, the length of hospital stay can be shortened, reducing the cost of treatment.

- ***Lighter and smaller appearance with improved privacy experience.*** With the development of technology, the appearance and functions of insulin pumps are better. Insulin pump is becoming more portable, with a lighter and smaller appearance. Take an example, the volume of MicroTech's Equil is reduced by about 65%, compared to the current traditional insulin pumps on the market, and the weight is greatly reduced. The privacy and the comfort of patients has been greatly improved. Compared with the traditional tubed insulin pump, the patch pump greatly improves the wearing comfort and freedom of movement, thus improving medication compliance.
- ***Tubeless design with improved safety, accuracy and portability.*** Compared with tubed pumps, the tubeless design of the patch pumps not only effectively resolve the safety problems caused by line blockage, but also free patients from the inconvenience of line entanglement and greatly improve wearing comfort while providing greater freedom in lifestyle choices. The tubeless design also effectively reduces the influence of the insulin pump on infusion accuracy when worn on different parts of the body as well as improving the accuracy and efficacy of blood glucose control.
- ***The closed loop artificial pancreas and intelligent closed loop control algorithm technology.*** The hybrid artificial pancreas has been clinically proven to be significantly better than the open insulin pump (manually controlled insulin pump combined with CGMS) in terms of blood glucose control and the incidence of hypoglycemia. In the future, with the continuous advancement of insulin pump, CGMS, and intelligent closed loop control algorithm technologies, artificial pancreas products with better clinical effects are expected to continue to develop and achieve a completely closed loop system.

INDUSTRY OVERVIEW

DIABETES MONITORING MEDICAL DEVICES MARKET

Overview of the Diabetes Monitoring Medical Devices Market

Diabetes monitoring medical devices can be classified as BGMS, CGMS and others, such as HbA1C and ketones testing.

- **BGMS:** BGMS usually collects blood drawn from the fingertip and uses disposable test strips to place into and reload the blood glucose meter so as to obtain single-shot blood glucose results.
- **CGMS:** CGMS measures glucose levels (typically interstitial glucose) continuously and updates the glucose level display every one to five minutes. CGMS can provide both retrospective as well as real-time information to measure glucose levels.
- **Others (like HbA1C and ketones testing):** Other devices include biochemical analyzers which are a specialized instrument used in hospitals to detect HbA1C, blood lipids, liver function, kidney function and other indicators.

The chart below shows the market size of the global diabetes monitoring medical devices market.

Global diabetes monitoring medical devices market, 2015-2030E

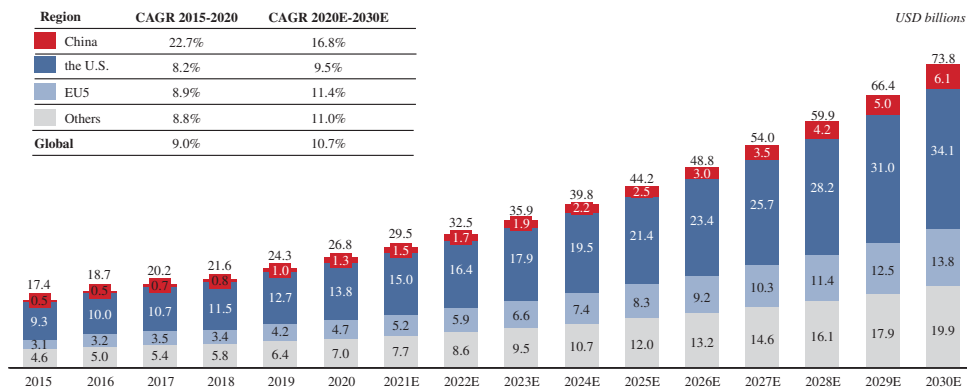

Source: CIC Report

INDUSTRY OVERVIEW

The chart below shows the market share of different types of diabetes monitoring medical devices in the global diabetes monitoring medical devices market.

**Global diabetes monitoring medical devices market, by type,
2015-2030E**

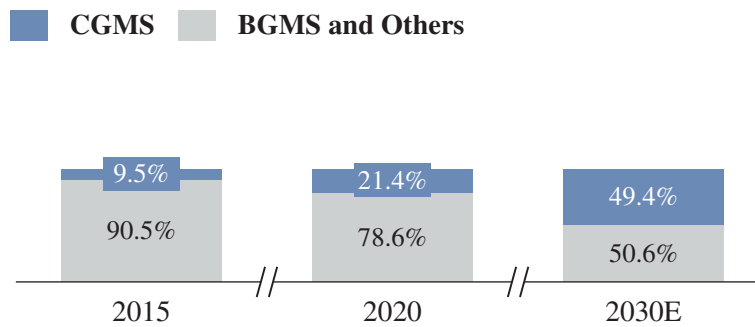

Source: CIC Report

CGMS Market

Overview of the CGMS Market

A CGMS measures the amount of glucose in the fluid that surrounds a human body’s cells – called interstitial fluid. Glucose in the interstitial fluid will come into contact with the sensor, causing a glucose-oxidation reaction to occur. A CGMS has three parts: (1) a sensor that sits just underneath the skin and measures glucose levels, (2) a transmitter that is attached to the sensor and sends glucose levels to a display device, and (3) a display device that shows glucose levels, as illustrated in the following figure.

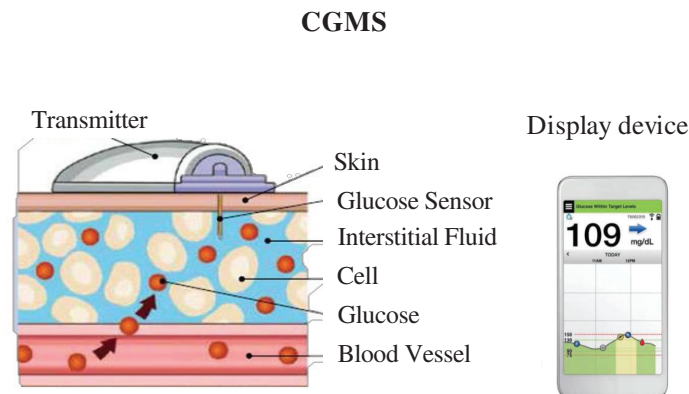

Source: CIC Report

INDUSTRY OVERVIEW

Compared to BGMS products, CGMS have the following advantages:

- ***Calibration-free CGMS avoids complex and painful finger pricking.*** BGMS requires a daily routine of finger pricking to monitor blood glucose levels. It is uncomfortable and painful for patients, which can result in a low compliance of testing. Calibration-free CGMS uses a micro electrochemical sensor to monitor glucose levels continuously for 24 hours. Patients do not need to test their glucose level several times a day and most CGMS last 7-14 days.
- ***CGMS can detect the monitoring blind area of BGMS.*** CGMS has a video-recording-like function that can record continuous glucose level whereas BGMS has a camera-like function that can only record noncontinuous glucose level. BGMS cannot alert users of their hypo- or hyperglycemic status due to the lack of continuous glucose monitoring, and is easy to miss data indicating extremely high or low glucose levels, which may cause misdiagnosis and even lead to the wrong treatment. CGMS can alert users of their high or low glucose status via both low- and high-level alarms set to user-defined thresholds and are able to ensure that a timely treatment can be given accordingly.
- ***CGMS can send real-time alarm of glucose level.*** CGMS can send real-time alarm of glucose level by using sound, LEDs, or vibrations as well as provide information on the PDA display, which reduces the risk of hyperglycemia and hypoglycemia.
- ***CGMS can be integrated with insulin pump to function as artificial pancreas.*** As a diabetes monitoring device, CGMS can be integrated with insulin pump to function as artificial pancreas. Artificial pancreas can realize the automation of treatment and monitoring, i.e., reducing high blood glucose levels (hyperglycemia) and minimizing the incidence of low blood glucose (hypoglycemia) with little to no input from the patients.

Based on whether or not a CGMS needs to be directly calibrated by the user with his/her fingertip to measure glucose level, CGMS can be divided into devices requiring fingertip calibration and those without requiring fingertip calibration. CGMS with calibration-free function (i.e., without requiring fingertip calibration) is more convenient and has high patient compliance level with lower possibility of infection as compared to CGMS that requires fingertip calibration.

Penetration Rates of CGMS in China and Globally

The CGMS market is at a fast-growing stage with a relatively low penetration rate. In the future, as more CGMS products are released, leading to a wider acceptance and adoption. Moreover, with people’s increasing healthcare awareness, the penetration rate for CGMS is expected to experience a significant growth in the future. In addition, compared to U.S. and EU5, the penetration rate for CGMS in China is much lower, indicating marketing opportunities and significant growth potential for medical device companies providing CGMS products in China. CGMS is currently not included under the national public medical insurance program in China. Inclusion of CGMS under the public medical insurance program in the future will promote the penetration and growth of the CGMS market in China. The charts below illustrate the penetration rate of CGMS in U.S., EU5 and China.

INDUSTRY OVERVIEW

Penetration rate of CGMS in the U.S., EU5 and China, 2020-2030E

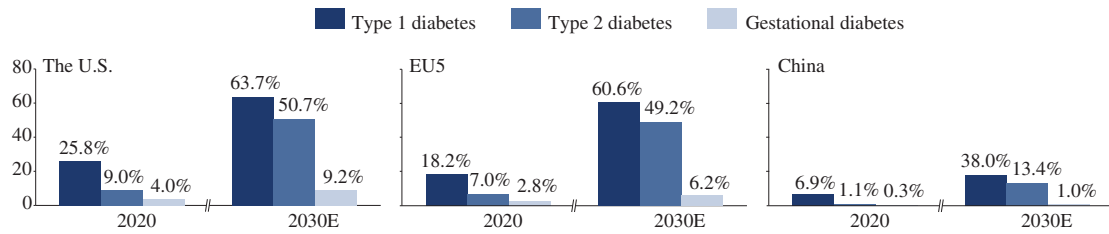

Source: CIC Report

CGMS Market Size

Due to the advantages of CGMS compared with BGMS and the rising acceptance of patients, the market size of the CGMS market in China is expected to increase from US\$0.1 billion in 2020 to US\$2.6 billion in 2030, at a CAGR of 34.0%. The market size of the CGMS market globally is expected to increase from US\$5.7 billion in 2020 to US\$36.5 billion in 2030, at a CAGR of 20.3%. The charts below show the market size of the global CGMS market.

Global CGMS devices market, 2015-2030E

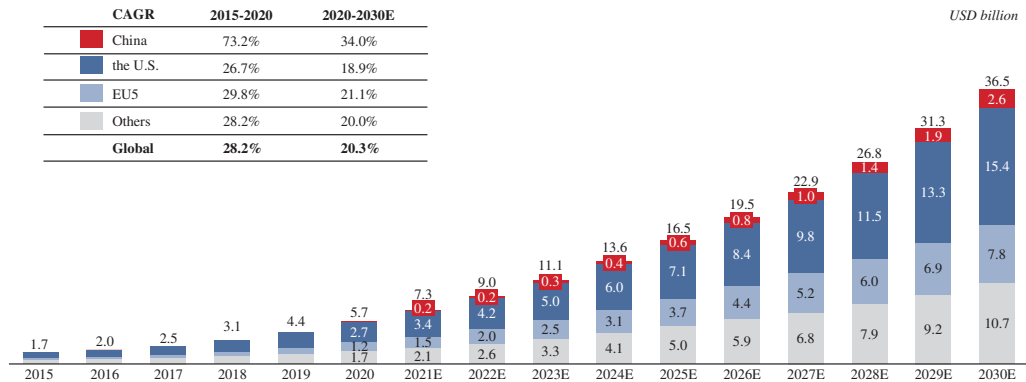

Source: CIC Report

Growth Drivers of the CGMS Market

In addition to the general industry growth drivers, such as the increasing number of diabetes patients and increasing disposal income and health expenditure, growth of the CGMS market is attributable to the following factors:

- Advantages compared to BGMS.** By avoiding the complex and painful daily routine of finger pricking, CGMS attracts more patients to use it to monitor daily glucose variation, and gain a higher compliance among patients using it. CGMS can also help diabetes patients understand their activities such as exercise, diet, and hypoglycemic therapy. The resulting changes in glucose level can prompt patients to strengthen comprehensive management and control of diabetes and choose a healthier life.





INDUSTRY OVERVIEW

- Advancement of CGMS technologies to improve the accuracy.** Technological advances have changed the face of diabetes monitoring in recent years. Sensors have become small wires with shallower penetration that no longer cause bruising. Monitors have become smaller and easier to use, bringing convenience to patients and improve compliance level of patients. In addition, most of CGMS manufactures developed tracing apps which are designed to generate easy-to-understand graphs and feedback, enabling patients to monitor and control their glucose level in a visible and effective way.
- Expansion of the use of CGMS.** Recognizing the benefits of more precise and customized diabetes treatment based on the data from CGMS, more and more patients with diabetes are expected to use CGMS. Calibration-free and high portability features of CGMS also add to the acceptance and recognition among patients. Moreover, CGMS is not only approved for patients with diabetes, and it may also be used to monitor glucose level for people that are not diagnosed with diabetes to control weight and manage dietary.
- Increasingly lower cost of CGMS.** With the clinical benefits, CGMS is expected to be covered by both medical insurance and commercial insurance, which will lower the purchase barrier of CGMS. Besides, as the technology of mass manufacturing of CGMS develops, the unit cost of CGMS is expected to be lower. Thus, patients can purchase CGMS at a relative low price, which will in turn increase the penetration of CGMS.

Competitive Landscape of the CGMS Market

The following tables set forth the major marketed CGMS products in the global market as of the Latest Practicable Date.

Global major marketed CGMS products

Performance	The Company's AiDEX G7	Abbott Freestyle Libre ProFlash	Medtronic Guardian	Dexcom G6
Calibration	Calibration-free	Calibration-free	Twice per day	Calibration-free
Usage Time	14 days	14 days	7 days	10 days
Startup Time	1 hour	1 hour	2 hours	2 hours
Transmitter Life	4 years	1 year (sensor integration)	1 year	3 months
Frequency of Readings	5 min (realtime)	15 min (retrospective)	5 min (realtime)	5 min (realtime)
Alarm Functions	Realtime high and low level glucose alarm	None	Realtime high and low level glucose alarm	Realtime high and low level glucose alarm
Built in Traditional Meter	Included	Included	None	None
Accuracy (MARD) ⁽¹⁾	9.1%	12.1%	9.1-10.6%	9.0%
Picture				

Note:

- (1) MARD refers to the mean absolute relative difference, which is the average value of the absolute error between the CGMS detection value and the referenced value. The lower the value, the higher the accuracy.

Source: CIC Report

INDUSTRY OVERVIEW

The following tables set forth the major CGMS products under development in the global market as of the Latest Practicable Date.

Global major CGMS products under development

Manufacturer	Product	R&D progress	Product Features
The Company	AiDEX G7	Pending NMPA approval	Calibration-free Real-time monitoring Usage time: 14 days
Dexcom	G7	Pending FDA approval	Calibration-free Smaller than G6 Usage time: 10 days
Abbott	Libre 3	Pending FDA approval	Calibration-free Real-time monitoring Smaller than libre 2 Usage time: 14 days
Senseonics	Eversense 180-day	Pending FDA approval	1 time per day calibration Real-time monitoring Usage time: 180 days
Medtronic	Zeus	Completed pivotal trial	Need calibration on the first day Usage time: 7 days
WaveForm Diabetes	Cascade	In clinical trial	1 time per day calibration Real-time data monitoring Usage time: 14 days

Source: CIC Report

ARTIFICIAL PANCREAS MEDICAL DEVICES INDUSTRY

Overview of the Artificial Pancreas Devices Market

An artificial pancreas device is a system-based device that closely mimics the glucose regulating function of a healthy pancreas. An artificial pancreas device is also referred to as a “closed loop” system. Artificial pancreas device consists of three important components: (1) a glucose sensor/monitor, (2) an insulin pump to store and deliver insulin, and (3) a control algorithm to compute the amount of insulin to be delivered and communicated between the sensor and the pump. The artificial pancreas device connects the treatment and monitoring functions of diabetes in a series, while the feedback regulation mechanism of a human pancreas is simulated by the closed loop control algorithm to realize the automation of treatment and monitoring.

Compared to these existing diabetes management medical devices, the artificial pancreas device connects the treatment and monitoring functions of diabetes in a series, while the feedback regulation mechanism of a human pancreas is simulated by the closed loop control algorithm to realize the automation of treatment and monitoring, i.e., reducing high blood glucose levels (hyperglycemia) and minimizing the incidence of low blood glucose (hypoglycemia) with little to no input from the patient.

INDUSTRY OVERVIEW

Market Size of the Artificial Pancreas Devices Market

The first artificial pancreas device in China is expected to be marketed by 2023. Based on its superior clinical advantages, the artificial pancreas device market in China is projected to reach US\$30.8 million in 2023 and approach to US\$488.4 million by 2030. The global pancreas device market increased from US\$522.4 million in 2017 to US\$1,053.9 million in 2020, at a CAGR of 26.4%, and is expected to further increase to US\$6,735.3 million, at a CAGR of 20.4% from 2020 to 2030. The chart below shows the market size of the artificial pancreas devices market in China.

China’s artificial pancreas device market, 2023-2030E

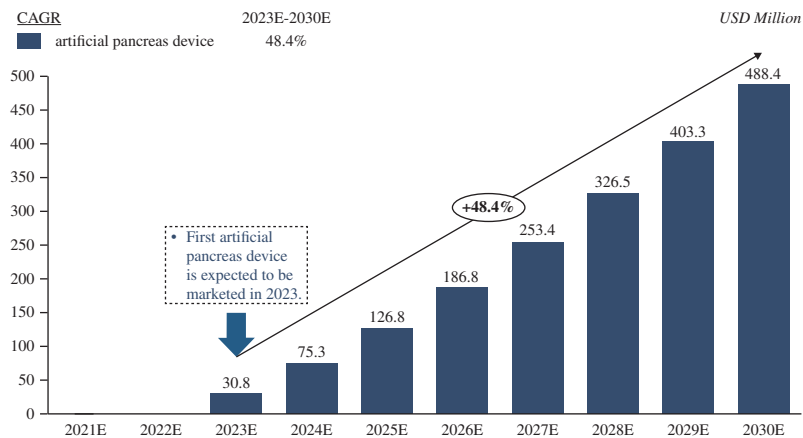

Source: CIC Report

The chart below shows the market size of the global artificial pancreas devices market.

Global artificial pancreas device market, 2017-2030E

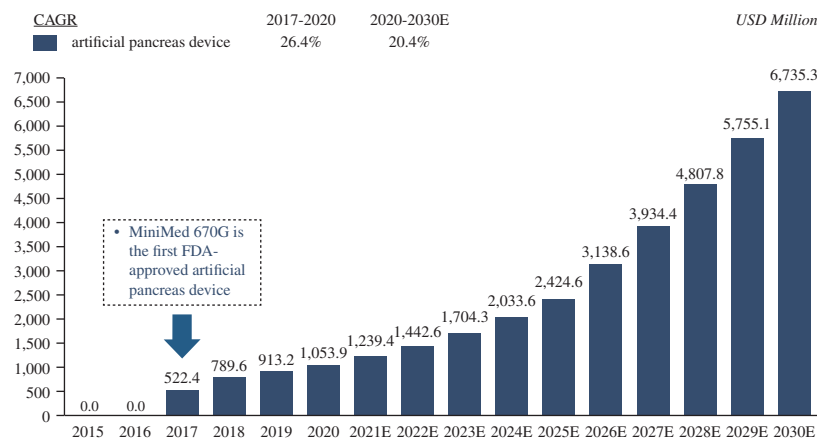



Source: CIC Report

INDUSTRY OVERVIEW

Competitive Landscape of the Artificial Pancreas Devices Market

According to the CIC Report, there was no artificial pancreas device marketed in China as of the Latest Practicable Date. The FDA had approved three artificial pancreas devices as of the Latest Practicable Date, which are set forth in the table below.

Major players in global artificial pancreas device market

Medtronic			Tandem	
				
Product	MiniMed 670G	MiniMed 770G	Product	Control-IQ hybrid closed loop
FDA approved date	Sep-2016	Sep-2020	FDA approved date	Dec-2019
Components	Calibration required CGMS + tubed pump	Calibration required CGMS + tubed pump	Components	Calibration-free CGMS + tubed pump
FDA approved patient group	≥7 years old patients with Type 1 diabetes	≥2 years old patients with Type 1 diabetes	FDA approved patient group	≥6 years old patients with Type 1 diabetes
Auto Mode	✓	✓	Auto Mode	✓
Basal Automation	✓	✓	Basal Automation	✓
Bolus Automation*	✗	✗	Bolus Automation	✓

Note:

* MiniMed 770G will recommend a correction bolus, but need to manually accept.

Source: CIC Report

There are only few companies developing artificial pancreas, such as Medtronic, MicroTech, Insulet and Dexcom, etc. According to the CIC Report, the Company’s artificial pancreas device is expected to become the world’s first closed loop solution based on self-developed calibration-free CGMS and patch insulin delivery system.

Growth Drivers of the Artificial Pancreas Devices Market

The artificial pancreas medical device market is expected to grow in the future mainly due to the following factors:

- Increasing demand due to the clinical benefits of artificial pancreas.** Artificial pancreas can improve life quality of patients with diabetes by improving patients’ blood glucose control throughout the day and overnight and reducing the risk of hypoglycemia. Besides, through glucose control, artificial pancreas can not only treat diabetes but also reduce the incidence of diabetic complications, which results in a huge demand from patients with diabetes. By reducing diabetic complications, artificial pancreas can also reduce social diabetic expenditure.

INDUSTRY OVERVIEW

- ***Continuous development of insulin pumps and CGMS.*** The continuous development and updates to insulin pumps, CGMS and closed loop control algorithm technologies are promoting the application and popularization of artificial pancreas technology. For example, real-time CGMS are able to realize the extraction of blood glucose level every one to five minutes, obtaining more accurate blood glucose data and detecting related changes, while insulin pump has achieved 24 hour real-time accurate infusion and the infusion rate can be adjusted every one to five minutes, providing better control of blood glucose level.
- ***More advanced AI algorithms.*** With more data and advanced AI algorithms, closed loop artificial pancreas systems with the intelligent control of insulin dosage will become more accurate and more effective at controlling blood glucose. Patients will not need to manually adjust the infusion dose before meals, and the artificial pancreas system can achieve the fully intelligent control of insulin dosage and the automatic regulation of blood glucose levels.

REPORT COMMISSIONED BY CHINA INSIGHTS INDUSTRY CONSULTANCY LIMITED

In connection with the [REDACTED], we have engaged CIC to conduct a detailed analysis and to prepare an industry report on diabetes management medical devices market and related markets. Services provided by CIC include market assessments, competitive benchmarking, and strategic and market planning for a variety of industries. CIC is an independent consulting firm founded in Hong Kong. It offers industry research and market strategies and provides growth consulting and corporate training.

We have included certain information from the CIC Report in this Document because we believe such information facilitates an understanding of the diabetes management medical devices market and related markets for potential [REDACTED]. CIC prepared its report based on its in-house database, independent third-party reports and publicly available data from reputable industry organizations. Where necessary, CIC contacts companies operating in the industry to gather and synthesize information in relation to the market, prices and other relevant information. CIC believes that the basic assumptions used in preparing the CIC Report, including those used to make future projections, are factual, correct and not misleading. CIC has independently analyzed the information, but the accuracy of the conclusions of its review largely relies on the accuracy of the information collected. CIC research may be affected by the accuracy of these assumptions and the choice of these primary and secondary sources.

We have agreed to pay CIC a fee of _____ for the preparation of the CIC Report. The payment of such amount was not contingent upon our successful [REDACTED] or on the content of the CIC Report. Except for the CIC Report, we did not commission any other industry report in connection with the [REDACTED]. We confirm that after taking reasonable care, there has been no adverse change in the market information since the date of the report prepared by CIC, which may qualify, contradict or have an impact on the information set forth in this section in any material respect.

REGULATORY OVERVIEW

LAWS AND REGULATIONS RELATING TO MEDICAL DEVICES

Regulation and Classification of Medical Devices

Pursuant to the Regulations on the Supervision and Administration of Medical Devices (《醫療器械監督管理條例》) (“**Regulations of Medical Devices**”) amended by the State Council and coming into effect on May 4, 2017, the China Food and Drug Administration of the State Council (now known as National Medical Products Administration) (國家藥品監督管理局) (“**NMPA**”) is in charge of the supervision and administration of medical devices nationwide. The relevant departments under the State Council shall be responsible for the supervision and administration with respect to medical devices within their respective scope of authorities. The food and drug supervision and administration departments of the local people’s governments at the county level and above are responsible for the supervision and administration of medical devices within their own administrative districts. The relevant departments of the local people’s governments at the county level and above are responsible for the supervision and administration with respect to medical devices within their respective scope of duties.

In the PRC, medical devices have been classified into three categories for administration based on the degree of risk. Class I medical devices shall refer to those devices with low risks, whose safety and effectiveness can be ensured through routine administration. Class II medical devices shall refer to those devices with moderate risks, which shall be strictly controlled and administered to ensure their safety and effectiveness. Class III medical devices shall refer to those devices with relatively high risks, which shall be strictly controlled and administered through special measures to ensure their safety and effectiveness.

The products we currently produce and sell in China are Class II and Class III medical devices, for which, we have obtained Class II and Class III medical device registration certificates which are all within the validity period.

In addition, the State Council promulgated the newly revised Regulations on Medical Devices on February 9, 2021 (which will take effect on June 1, 2021). This revision implements the registrant-or-submitter accountability systems, and further highlights the entity responsibilities of enterprises, encourages innovation in medical devices, and increase punishment cases and reinforces penalty and punishment for illegal act.

Registration and Filing of Medical Devices

According to the Regulations of Medical Devices and the Administrative Measures for the Registration of Medical Devices (《醫療器械註冊管理辦法》) coming into effect on October 1, 2014, Class I medical devices are subject to filing administration, and the filing applicants shall submit the filing materials to the food and drug supervision and administration departments of the people’s governments of the local municipalities with districts. In case of any change to the matters specified in the filing materials, the filing applicants shall apply for the filing of change with the original filing department. Class II and Class III medical devices

REGULATORY OVERVIEW

are subject to registration administration. Class II medical devices shall be examined by the drug supervision and administration departments of the people’s governments of the provinces, autonomous regions and municipalities directly under the central government where the registration applicants are located, and a Medical Device Registration Certificate (醫療器械註冊證) for such medical devices shall be issued upon approval. Class III medical devices shall be examined by the NMPA, and a Medical Device Registration Certificate for such medical devices shall be issued upon approval. In case of any substantial change of the designs, raw materials, production technologies, scopes of application and application methods, etc., of the registered Class II or Class III medical devices, which may affect the safety and effectiveness of such medical devices, the registrants shall apply to the original registration departments for changing registration.

The Medical Device Registration Certificate is valid for five years and the registrant shall apply to the food and drug supervision and administration departments for renewal, if necessary, at least six months prior to its expiration date.

Clinical Trial

According to the Administrative Measures for the Registration of Medical Devices, clinical trials are not required for the filing of the Class I medical devices, but are necessary for the application for the registration of the Class II and Class III medical devices. However, medical devices may be exempt from clinical trials under any of the following circumstances:

- (i) The medical device has clear working mechanisms, finalized design and mature manufacturing processes, and the medical devices of the same kind that are available on the market have been used in clinical practice for years without records of any seriously adverse events and with their general purposes unchanged;
- (ii) The safety and effectiveness of such medical device can be proved through non-clinical evaluation; or
- (iii) The safety and effectiveness of such medical device can be proved through the analysis and evaluation of the data obtained from the clinical trials or clinical application of the same kind of medical devices.

The catalogue of the medical devices exempt from clinical trials shall be formulated, adjusted and published by the NMPA. For the products that are not included in the catalogue of the medical devices exempt from clinical trials but whose safety and effectiveness can be proved through the data obtained from the clinical trials or clinical application of the same kind of medical devices, the applicants may, at the time of applying for registration, provide description and submit relevant proofing materials.

REGULATORY OVERVIEW

Clinical trial on medical devices shall be conducted by organizations that possess relevant qualifications as required by the Good Clinical Practice for Medical Devices Trial. According to the Good Clinical Practice for Medical Devices (《醫療器械臨床試驗質量管理規範》), which came into effect on June 1, 2016, the Good Clinical Practice includes full procedures of clinical trial of medical devices, including, among others, the protocol design, conduct, monitoring, verification, inspection, and data collection, recording, analysis and conclusion and reporting procedure of a clinical trial. Prior to a clinical trial, the applicant shall complete the preclinical study of the investigational medical devices, including product design (structural composition, working principle and mechanism of action, intended use and scope of application, applicable technical requirements) and quality inspection, animal trial and risk analysis, and the result shall support the clinical trial. Clinical trial of medical devices shall be conducted in two or more clinical trial institutions of medical devices. Prior to the clinical trial, the applicant shall enter into an agreement in writing with the clinical trial organization and researchers regarding matters such as the design of the trial, quality control of the trial, division of responsibility in the trial, fees to be borne by the applicant in relation to the clinical trial and principles in handling potential harm in the trial. The clinical trial shall be subject to the approval of the ethics committee of clinical trial institution of medical devices. The medical devices included in the List of Class III Medical Devices Requiring Clinical Trial Approval shall also be approved by the NMPA. Before a clinical trial, the applicant shall file with the supervision and administration departments of the provinces, autonomous regions or municipalities where it is located.

Medical Devices Production Permit (醫療器械生產許可)

The Regulations of Medical Devices and the Administrative Measures on the Production of Medical Devices (《醫療器械生產監督管理辦法》) (the “**Measures on the Production**”) amended and coming into effect on November 17, 2017 stipulates the following conditions which a producer of medical devices shall satisfy:

- (i) possessing production sites, environmental conditions, production equipment and professional technicians that are suitable for such medical device produced;
- (ii) possessing organizations or professional examination staff and examination equipment for quality examination of such medical device produced;
- (iii) formulating a management system which ensures the quality of such medical device;
- (iv) having capability of after-sale services that is suitable for such medical device produced; and
- (iv) satisfying the requirements as prescribed in production R&D and production technique documents.

REGULATORY OVERVIEW

An enterprise engaged in the production of Class I medical devices shall make filing relating to the production of such Class I medical devices with the food and drug supervision and administration department of the people’s government of the local city with districts and provide proofing materials for its satisfying the relevant conditions of engaging in the production of medical devices; an enterprise engaged in the production of Class II and Class III medical devices shall apply for a production permit to the food and drug supervision and administration departments of the people’s governments of the provinces, autonomous regions and municipalities directly under the central government where it is located and provide proofing materials for its satisfying the relevant conditions of engaging in the production of such medical devices.

The production permit for a medical device is valid for five years and the producer of the relevant medical device shall apply for renewal, if necessary, to the original department that issued such permit at least six months prior to its expiration date.

Production and Quality Management of Medical Devices

The Standards on Production and Quality Management of Medical Devices (《醫療器械生產質量管理規範》) (the “**Standards on Production and Quality Management**”) which came into effect on March 1, 2015, stipulates that an enterprise engaging in the production of medical devices shall establish and effectively maintain a quality control system in accordance with the requirements of the Standards on Production and Quality Management. The enterprise engaging in the production of medical devices shall regularly conduct comprehensive self-inspection on the operation of quality management system in accordance with the requirements of the Standards on Production and Quality Management and submit an annual self-inspection report to the food and drug supervision and administration department of the people’s government of the province, autonomous region and municipality directly under the central government where it is located or the local municipality with districts before the end of every year.

The enterprise shall establish its procurement control procedure and examine and assess its suppliers by establishing an examination system to ensure that the purchased products are in compliance with the statutory requirements. The enterprise shall record the procurement, production and inspection of raw materials. Such records shall be true, accurate, complete and traceable. The enterprise shall apply risk management to the whole process of design and development, production, sales and after-sale services. The measures being adopted shall be applicable to risks of the related products.

Pursuant to The Notice of Four Guidelines including On-site Inspection Guidelines for the Standards on Production and Quality Management of Medical Devices (《關於印發<醫療器械生產質量管理規範現場檢查指導原則>等4個指導原則的通知》) promulgated and coming into effect on September 25, 2015, during the course of on-site verification of the registration of medical devices and on-site inspection of production permit (including changing registration), the inspection team shall, in accordance with the guidelines, issue recommended conclusions for on-site inspections, which shall be divided into “Passed,” “Failed” or “Reassessment after

REGULATORY OVERVIEW

rectification.” During the supervision and inspection, if key items are found to be non-compliant, or only general items are found to be non-compliant, which may have a direct impact on product quality, the enterprise shall be required to stop production for rectification; if only general items are found to be non-compliant, which does not directly affect the product quality, the enterprise shall be required to make rectification within a time limit. The regulatory authorities shall examine and verify the recommended conclusions and on-site inspection materials submitted by the inspection group and issue the final inspection results.

Administration of Medical Devices Operation

Pursuant to the Regulations of Medical Devices and the Measures for the Supervision and Administration of Medical Devices Operation (《醫療器械經營監督管理辦法》), promulgated on July 30, 2014, coming into effect on October 1, 2014 and amended on November 17, 2017, an enterprise engaging in the operation of medical devices shall have business premises and storage conditions suitable for the operation scale and scope, and shall have the quality management system and quality management institution or quality management personnel suitable for the medical devices it operates. An enterprise engaged in the operation of Class II medical devices shall make filing with the local food and drug supervision and administration department at the level of city with districts and provide proofing materials for its satisfying the relevant conditions of engaging in the operation of medical devices, while an enterprise engaged in the operation of Class III medical devices shall apply for an operation permit to the local food and drug supervision and administration department at the level of city with districts and provide proofing materials for its satisfying the relevant conditions of engaging in the operation of such medical devices.

The food and drug supervision and administration department which accepts operation permit application shall grant the operation permit if the enterprise meets the prescribed requirements. An operation permit is valid for five years and may be renewed pursuant to the relevant regulations. An enterprise engaging in the operation of medical devices shall not operate or use any medical device that has not been legally registered, has no qualification certificate, or is out-dated, invalid or eliminated.

Special Procedures for Examination and Approval of Innovative Medical Devices

On October 8, 2017, the General Office of the CPC Central Committee and the General Office of the State Council jointly issued the Opinions on Deepening the Reform of the Evaluation and Approval Systems and Encouraging Innovation on Drugs and Medical Devices (《關於深化審評審批制度改革鼓勵藥品醫療器械創新的意見》) (the “**Innovation Opinions**”), which aims to encourage the research and development of innovative medical devices. Pursuant to the Innovation Opinions, the priority review and approval will be applicable to innovative medical devices supported by the National Science and Technology Major Projects and the National Key R&D Program (國家科技重大專項和國家重點研發計劃支持項目) of the PRC, and the clinical trials of which have been conducted, and approved by the management department of the National Clinical Research Center. Pursuant to the Special Procedures for Examination and Approval of Innovative Medical Devices (《創新醫療器械特

REGULATORY OVERVIEW

別審查程序》) which were promulgated on November 2, 2018 and came into effect on December 1, 2018, special procedures shall be applicable to the examination and approval for medical devices in the following circumstances:

- (i) The applicant legally owns the invention patent of the core technology of the product in the PRC through its leading technological innovation activities, or legally obtains the invention patent or the right of use thereof through transfer in the PRC, and the interval between the date of application for the special examination and approval of innovative medical devices and the date of authorized publication should not exceed five years; or the patent administration department of the State Council has disclosed the application for the invention patent of the core technology and the Patent Search and Consultation Center of the National Intellectual Property Administration of the PRC (國家知識產權局專利檢索諮詢中心) has issued the patent search report setting out the novelty and innovation of the core technology solution of the product.
- (ii) The applicant has completed the preliminary research of the product and developed the prototype product under a true and controllable process that generated complete and traceable data.
- (ii) The product (a) has major working mechanism or mechanism of action which is the first of its kind in the PRC, (b) has fundamental improvement in product performance or safety compared with similar products, (c) is of an internationally leading standard in terms of techniques and has significant clinical application value.

The Center for Medical Device Evaluation of the NMPA (國家藥品監督管理局醫療器械技術審評中心) shall give priority to the innovative medical devices in their technical review upon receiving the registration application, after which the NMPA shall give priority to the product in their administrative approval.

Centralized Procurement of Medical Devices

Pursuant to the Notice on Further Strengthening the Administration of Centralized Procurement of Medical Devices (《關於進一步加強醫療器械集中採購管理的通知》) issued by the Ministry of Health on June 21, 2007, centralized procurement of medical devices shall be subject to geographic administration. It shall be led by the government and conducted at three levels, namely, the central level, the provincial level and the municipal level, and mainly at the provincial level. All non-profit medical institutions founded by the governments at various levels, industries and state-owned enterprises shall participate in centralized procurement of medical devices. No medical institution may evade centralized procurement in any way. The medical devices as mentioned above refers to medical equipment and medical consumables.

REGULATORY OVERVIEW

Two-invoice System

According to the Notice on Opinions on the Implementation of the “Two-invoice System” in Drug Procurement by Public Medical Institutions (for Trial Implementation) (《關於在公立醫療機構藥品採購中推行“兩票制”的實施意見(試行)的通知》) (the “**Notice**”), jointly issued by the Medical Reform Office of the State Council (國務院醫改辦), the National Health and Family Planning Commission (國家衛生計生委), China Food and Drug Administration (國家食品藥品監管總局), the National Development and Reform Commission (國家發展改革委), the Ministry of Industry and Information Technology (工業和信息化部), the Ministry of Commerce (商務部), the State Taxation Administration (國家稅務總局) and the National Administration of Traditional Chinese Medicine (國家中醫藥管理局) on December 26, 2016, the “Two-invoice System” refers to the system that requires one invoice to be issued from pharmaceutical manufacturers to pharmaceutical distributors and the other invoice to be issued from pharmaceutical distributors to medical institutions. The Notice requires the gradual implementation of the “Two-invoice System” in drug procurement by public medical institutions, encourages other medical institutions to implement the “Two-invoice System”, and strives to promote the “Two-invoice System” in full swing nationwide by 2018.

As of the Latest Practice Date, the relevant regulations with respect to the “Two-invoice System” have been promulgated in some provinces in the PRC and the reform of the “Two-invoice System” is under way.

Regulations Relating to Advertisements of Medical Devices

According to the Regulations on Medical Devices, the advertisements of a medical device shall be true and lawful, and its content shall not be false, exaggerated or misleading. Advertisements for medical devices shall be examined and approved by the food and drug supervision and administration departments of the people’s governments of the provinces, autonomous regions or municipalities where the manufacturing enterprises of medical devices or the agents of imported medical devices are located, and obtain the approval document for such advertisements for medical devices. A publisher of a medical device advertisement shall verify approval documents and their authenticity prior to the publication; if no approval document was obtained or the authenticity of any approval document has not been verified or the content of the advertisement is inconsistent with the approval documents, such medical device advertisement shall not be published.

According to the Interim Administrative Measures for Censorship of Advertisements for Drugs, Medical Devices, Dietary Supplements and Foods for Special Medical Purposes (《藥品、醫療器械、保健食品、特殊醫學用途配方食品廣告審查管理暫行辦法》) issued on December 24, 2019 and became effective on March 1, 2020, no advertisement of medical devices shall be published without examination. The State Administration for Market Regulation (國家市場監督管理總局) (the “**SAMR**”) shall be responsible for organizing and guiding the examination of advertisements of medical devices, and the administration for market regulation and administration for drugs of provinces, autonomous regions and municipalities shall be responsible for the advertisement examination of medical devices, and

REGULATORY OVERVIEW

may entrust other administrative organs to carry out advertisement examination according to law. The contents of a medical device advertisement shall be based on the contents of the registration certificate or filing certificate approved by the drug administrations, or the registered or filed product instructions. Where the medical device advertisement involves the name, scope of application, functional mechanism or structure or composition, etc. of the medical device, the scopes of the registration certificate or filing certificate, or registered or filed product instruction shall not be exceeded.

National Medical Insurance Program

The national medical insurance program was implemented pursuant to the Decision of the State Council on the Establishment of the Urban Employee Basic Medical Insurance Program (《關於建立城鎮職工基本醫療保險制度的決定》) issued by the State Council on December 14, 1998, under which, all employers in urban cities are required to enroll their employees in the Urban Employee Basic Medical Insurance Program and the insurance premium is jointly contributed by the employers and employees. Pursuant to the Opinions on the Establishment of the New Rural Cooperative Medical System (《關於建立新型農村合作醫療制度意見的通告》) forwarded by the General Office of the State Council on January 16, 2003, China launched the New Rural Cooperative Medical System to provide medical insurance for rural residents in selected areas which has spread to the whole nation thereafter. The State Council promulgated Guiding Opinions of the State Council about the Pilot Urban Resident Basic Medical Insurance (《國務院關於開展城鎮居民基本醫療保險試點的指導意見》) on July 10, 2007, under which urban residents of the pilot district, rather than urban employees, may voluntarily join Urban Resident Basic Medical Insurance. In 2015, the General Office of the State Council issued the Outline for the Planning of the National Medical and Health Service System (2015-2020) (《全國醫療衛生服務體系規劃綱要(2015-2020年)》) which aimed to establish a basic medical and health care system that covers both rural and urban citizens by 2020.

On January 3, 2016, the State Council issued the Opinions on Integrating the Basic Medical Insurance Systems for Urban and Rural Residents (《國務院關於整合城鎮居民基本醫療保險制度的意見》) to integrate the Urban Resident Basic Medical Insurance and the New Rural Cooperative Medical System and the establishment of a unified Basic Medical Insurance for Urban and Rural Residents, which will cover all rural and non-working urban residents except for rural migrant workers and persons in flexible employment arrangements who participate in the basic medical insurance for urban employees.

With regard to reimbursement for medical devices and diagnostic tests, the Notice of Opinion on the Diagnosis and Treatment Management, Scope and Payment Standards of Medical Service Facilities Covered by the National Urban Employees Basic Medical Insurance Scheme (Lao She Bu Fa [1999] No. 22) (《關於印發<城鎮職工基本醫療保險診療項目管理、醫療服務設施範圍和支付標準意見>的通知》(勞社部發[1999]22號)) issued by the Ministry of Labor and Social Security (勞動和社會保障部) prescribes the coverage of diagnostic and treatment devices and diagnostic tests where part of the fees are paid through the basic medical

REGULATORY OVERVIEW

insurance scheme. It also includes a negative list that precludes certain devices and medical services from governmental reimbursement. Detailed reimbursement coverage and rate for medical devices and medical services (including diagnostic tests and kits) are subject to each province's local policies.

Export Sales Certificates of Medical Devices

Pursuant to the Regulations on the Administration of Export Sales Certificates of Medical Devices (《醫療器械產品出口銷售證明管理規定》), which was promulgated on June 1, 2015 and came into effect on September 1, 2015, if the registration certificate for a medical device and production permit for a medical device have been obtained in China, or the medical device registration and production filing have been completed, the food and drug supervision and administration department may issue a Medical Device Product Export Sales Certificate (醫療器械產品出口銷售證明) to the relevant manufacturing enterprise. The validity term of the Medical Device Product Export Sales Certificate should not exceed the earliest deadline for the various documents submitted by the enterprise in the application materials, and the maximum validity term shall also not exceed two years.

Medical Device Recalls

Pursuant to the medical device regulations and the Administrative Measures for Medical Device Recalls (《醫療器械召回管理辦法》), which was promulgated on January 25, 2017 and came into effect on May 1, 2017, in light of the severity harm, medical device recalls are divided into: (i) Class I recall where the circumstances leading to the recall may cause or have caused serious health hazards; (ii) Class II recall where the circumstances leading to the recall may cause or have caused temporary or reversible health hazards; or (iii) Class III recall where the circumstances leading to the recall are not likely to cause harm but such medical device still needs to be recalled. Medical device manufacturers shall determine the recall class based on the specific situation and properly design and implement the recall plan based on the recall class and the sale and use of the medical devices.

In terms of class I recall, the recall notice of the medical devices shall be published on the NMPA website and major central media. In terms of Class II and Class III recalls, the recall notice of the medical devices shall be published on the website of the food and drug administrative authority at the level of provinces, autonomous regions or municipalities.

Online Sales of Medical Device

According to the Administration and Supervision Measures of Online Sales of Medical Devices (《醫療器械網絡銷售監督管理辦法》), which was promulgated on December 20, 2017 and came into effect on March 1, 2018, enterprises engaged in online sales of medical devices must be medical device manufacture and operation enterprises with medical devices production licenses or operation licenses or being filed for record in accordance with laws and regulations, and shall carry out online sales activities of medical devices through its own website or the third-party platform of online medical devices transaction services. The

REGULATORY OVERVIEW

enterprises engaging in online sales of medical devices through their own website shall obtain an Internet Drug Information Services Qualification License (互聯網藥品信息服務資格證書) according to law, and have the appropriate office space and technical conditions for data backup and failure recovery in line with the business scale. The third-party platform provider shall obtain an Internet Drug Information Services Qualification License in accordance with the law, have the appropriate office space and technical conditions for data backup and failure recovery in line with the business scale, and set up a special medical device network quality and safety management organization or equip medical device quality and safety management personnel.

OTHER LAWS AND REGULATIONS

Regulations Relating to Labor and Social Protection and Housing Provident Fund

Pursuant to the PRC Labor Law (《中華人民共和國勞動法》) promulgated on July 5, 1994 and amended on December 29, 2018 by the Standing Committee of the National People's Congress (全國人民代表大會常務委員會) (the "SCNPC"), the PRC Labor Contract Law (《中華人民共和國勞動合同法》) amended by the SCNPC on December 28, 2012 and taking into effect on July 1, 2013, and the Implementing Regulations of the PRC Labor Contract Law (《中華人民共和國勞動合同法實施條例》) promulgated by the State Council and taking into effect on September 18, 2008, an employer shall strictly comply with the national standards, provide training to its employees, protect their labor rights and perform its labor obligations. An employer shall enter into written labor contracts with its employees. Labor contracts shall be categorized into labor contracts with fixed term, labor contracts without fixed term and labor contracts to be expired upon completion of certain tasks. Wages payable by an employer to its employees shall not be less than local minimum wage. Employers must establish a system for labor safety and sanitation, strictly abide by state standards for labor safety and sanitation and provide relevant education to its employees. Violations of the PRC Labor Law and the PRC Labor Contract Law may result in the imposition of fines and other administrative liabilities and may incur criminal liabilities in the case of serious circumstances.

According to the Law on Social Insurance of the PRC (《中華人民共和國社會保險法》) promulgated on October 28, 2010 and amended on December 29, 2018 by the SCNPC and the Provisional Regulations on the Collection and Payment of Social Insurance Premiums (《社會保險費徵繳暫行條例》) amended by the State Council and taking effect on March 24, 2019, a domestic enterprise shall pay pension insurance, unemployment insurance, maternity insurance, work injury insurance and basic medical insurance for its employees at the applicable rates based on the amounts stipulated by the laws. If it fails to pay required amount of premium to the relevant local administrative authorities on time and in full, the employer it may be required to settle the overdue amount or subject to fine. At the same time, the Regulation on Work Injury Insurance (《工傷保險條例》), the Regulations on Unemployment Insurance (《失業保險條例》), the Provisional Measures on Maternity Insurance for Enterprise Employees (《企業職工生育保險試行辦法》) and other laws and regulations contain specific clauses on different types of social insurance. Enterprise governed by such laws and regulations shall pay corresponding insurance premiums for their employees.

REGULATORY OVERVIEW

According to Regulations on the Administration of Housing Provident Fund (《住房公積金管理條例》), which was implemented on April 3, 1999, and was amended on March 24, 2002 and March 24, 2019, a newly established entity shall make deposit registration for housing provident fund at the housing provident fund management center within 30 days since its establishment and shall complete the housing provident fund account establishment procedures for its employees within 20 days from the date of registration. Within 30 days as at the date an employee is recruited, the entity shall make deposit registration at the housing provident fund management center and go through the procedures for the establishment or transfer of an employee's housing provident fund account. With respect to any entity that fails to make deposit registration of the housing provident fund or fails to complete the housing provident fund account establishment procedures for its employees, such entity shall be ordered by the housing provident fund management center to complete such procedures within a prescribed time limit; where failing to do so at the expiration of the time limit, a fine of not less than RMB10,000 nor more than RMB50,000 shall be imposed. Any entity fails to make payment of housing provident fund within the time limit or has shortfall in payment of housing provident fund will be ordered by the housing provident fund management center to make the payment or make up the shortfall within the prescribed time limit, otherwise, the housing provident fund management center is entitled to apply for compulsory enforcement with the people's court.

Production Safety

Pursuant to the Production Safety Law of the PRC (《中華人民共和國安全生產法》) amended by the SCNPC on August 31, 2014 and taking into effect on December 1, 2014, an enterprise shall (i) provide production safety conditions as stipulated in this law and other relevant laws, administrative regulations, national and industry standards, (ii) establish the responsibility system and rules and regulations for production safety, and (iii) develop production safety standards to ensure production safety. Any entity that fails to provide required production safety conditions is prohibited from engaging in production activities.

The person-in-charge of an enterprise shall be fully responsible for the safety of production of the enterprise. An enterprise having more than 100 employees shall establish a department or engage in personnel managing production safety specifically. Personnel who is responsible for managing production safety shall inspect the safety of production regularly based on the characteristics of production of the enterprise and shall deal with any safety issue identified during the inspection in a timely manner. Any unsolved issue shall be reported to the person-in-charge in a timely manner and the person-in-charge shall solve such issue immediately. The inspection and measures taken shall be duly recorded. Enterprises and institutions shall provide their employees with training on production safety and shall truthfully inform their employees of any potential risks in relation to the workplace and duties, preventive measures and emergency measures. In addition, an enterprise shall provide its employees with protective equipment that meet the national or industry standards and supervise and train them to use such equipment.

REGULATORY OVERVIEW

Regulations Relating to Environmental Protection

Environmental Protection

The Environmental Protection Law of the People's Republic of China (《中華人民共和國環境保護法》), promulgated by the SCNPC on December 26, 1989 and amended on April 24, 2014, summarizes the rights and responsibilities of environmental protection regulatory authorities. The Ministry of Environmental Protection (now the Ministry of Ecology and Environment) (生態環境部) is authorized to promulgate national standards for environmental quality and discharge and to supervise China's environmental protection policies. At the same time, local environmental protection authorities may formulate local standards that are stricter than the national standards, in which case, the companies concerned shall comply with the national and local standards.

Environmental Impact Assessment

According to the Regulations on the Administration of Construction Project Environmental Protection (《建設項目環境保護管理條例》) promulgated by the State Council on November 29, 1998 and amended on July 16, 2017 and taking effect on October 1, 2017, the construction entity shall submit an environmental impact report or an environmental impact statement, or fill in a registration form depending on the degree of impact the construction project has on environment. For a construction project for which an environmental impact report or environmental impact statement shall be prepared, the construction entity shall submit the environmental impact report and environmental impact statement to the competent administrative department of the environmental protection for approval before starting construction. If the Environmental Impact Assessment Documents of a construction project have not been reviewed by the approving authority in accordance with the law or have not been granted approval after the review, the construction unit shall be prohibited from commencing construction works.

According to the Law of the People's Republic of China on Environmental Impact Assessment (《中華人民共和國環境影響評價法》) promulgated by the SCNPC on October 28, 2002 and amended on July 2, 2016 and December 29, 2018, for construction projects that have an impact on the environment, entities shall prepare an environmental impact report, report form or registration form in accordance with the severity of the impact that the project may have on the environment.

Completion and Acceptance

The Interim Measures for Acceptance of Environmental Protection upon Completion of Construction Projects (《建設項目竣工環境保護驗收暫行辦法》) was promulgated and implemented by the former Ministry of Environmental Protection (now the Ministry of Ecology and Environment) on November 20, 2017. The Measures regulates the procedures and standards for environmental protection acceptance by construction units upon the completion of construction projects.

REGULATORY OVERVIEW

Product Responsibility

Pursuant to the Product Quality Law of the PRC (《中華人民共和國產品質量法》) which was amended by the SCNPC and came into effect on December 29, 2018, producers and sellers shall have their own proper regulations for the management of product quality, rigorously implementing post-oriented quality regulations, quality liabilities and relevant measures for their assessment. Producers and sellers are responsible for the product quality according to the provisions of the laws. The product quality supervision and administration departments of the State Council are responsible for the supervision of the quality of products of the whole country. All relevant departments of the State Council shall be responsible for the supervision of product quality within their own functions and duties. Quality of products shall pass standard examinations and it is not allowed to pass off sub-standard products as standard ones. Industrial products which may be hazardous to the health of people and the safety of lives and property shall conform to the State and trade standards for ensuring the health of the human body and safety of lives and property. Where no such State or trade standards have been formulated, the products shall conform to the minimum requirements for ensuring the health of the human body and the safety of lives and property. It shall be prohibited to produce or sell industrial products that do not meet the requirements and demands for physical health and safety of body and property. Producers or sellers shall be responsible for any compensation arising from their unlawful acts such as production or sales of defective, eliminated or ineffective products, faking the place of origin or quality marks, mixing or adulterating products or passing off imitations as genuine, substandard products as quality ones or non-conforming products as conforming, while the proceeds from the sales may be confiscated, the business license may be revoked, and penalties may be imposed. If the case is serious, criminal responsibilities shall be investigated. Producers or sellers shall be liable for any damage to any person or property due to the defects of products resulting from the default of the producers or sellers.

According to the Civil Code of the People's Republic of China (《中華人民共和國民法典》) taking effect on January 1, 2021, if the personal and property safety of others is endangered due to product defect, the infringed party shall have the right to request the producer and seller to undertake the tort liability such as stopping the infringement, removing the obstruction and eliminating the danger. The injured person may claim compensation from the producer or seller. Where the product defect is caused by the producer, the seller may, after paying compensation, claim the same from the producer. Where the product defect is caused by the fault of the seller, the producer may, after paying compensation, claim the same from the seller.

Regulations Relating to Intellectual Property Rights

Trademarks

The Trademark Law of the People's Republic of China (《中華人民共和國商標法》) amended by the SCNPC on April 23, 2019 and taking effect on November 1, 2019, and the Regulation on the Implementation of the Trademark Law of the People's Republic of China

REGULATORY OVERVIEW

(《中華人民共和國商標法實施條例》) amended by the State Council on April 29, 2014 and taking effect on May 1, 2014 stipulate the application, examination and approval, renewal, modification, transfer, use and invalidation of trademark registration, and protect the exclusive right to use a trademark enjoyed by the trademark registrant. According to the above-mentioned laws and regulations, the valid period of a registered trademark shall be 10 years, commencing from the date of approval of the registration. Upon expiry of the period of validity of a registered trademark, the registrant shall go through the formalities for renewal within twelve months prior to the date of expiry as required if the registrant needs to continue to use the trademark. Where the registrant fails to do so, a grace period of six months may be granted. The valid period for each renewal of registration is 10 years, counted from the next day of the expiration day of the last term of such trademark. Trademark registrant may license its registered trademark to another party by entering into a trademark license agreement.

Patent

According to the Patent Law of the PRC (《中華人民共和國專利法》) (the “**Patent Law**”) which was amended by the SCNPC on December 27, 2008 and came into effect on October 1, 2009 and the Rules for the Implementation of the Patent Law of the PRC (《中華人民共和國專利法實施細則》) which was amended by the State Council on January 9, 2010 and came into effect on February 1, 2010, patents in China are divided into invention patent, utility patent and design patent. An invention patent is granted to a new technical solution proposed in respect of a product or method or an improvement of a product or method. A utility patent is granted to a new technical solution that is practicable for application and proposed in respect of the shape, structure or a combination of both of a product. A design patent is granted to the new design of a certain product in shape, pattern or a combination of both and in color, shape and pattern combinations aesthetically suitable for industrial application. The duration of a patent right for inventions shall be 20 years and the duration of a patent right for utility models and designs shall be 10 years, both commencing from the filing date. The patent right entitled to its owner shall be protected by the laws. Others may use the patent after obtaining the permit or proper authorization of the patent holder, otherwise such behavior will constitute an infringing act of the patent right.

On October 17, 2020, the SCNPC published the amendment to the Patent Law of the PRC (the “**Amendment to the Patent Law**”) (《專利法修正案》). The Amendment to the Patent Law will be formally implemented on June 1, 2021. Compared with the current Patent Law, the main changes in the Amendment to the Patent Law focus on the following aspects: (i) defining the incentive mechanism for the inventor or designer to share the benefits of invention and creation; (ii) extending the term of appearance design patent; (iii) establishing a new “open license” system; (iv) improving the sharing of the burden of proof in patent infringement cases; and (v) increasing the compensation amount of damages for patent infringement.

REGULATORY OVERVIEW

Copyright

The Copyright Law of the PRC (《中華人民共和國著作權法》) (the “**Copyright Law**”), which was amended by the SCNPC on February 26, 2010 and came into effect on April 1, 2010, and the Rules for the Implementation of the Copyright Law of the PRC (《中華人民共和國著作權法實施條例》) which was amended by the State Council on January 30, 2013 and came into effect on March 1, 2013, specifies that works of Chinese citizens, legal persons or other organizations, including literature, art, natural sciences, social sciences, engineering technologies and computer software created in writing or oral or other forms, whether published or not, all enjoy the copyright. A copyright holder shall enjoy a number of rights, including the right of publication, the right of authorship and the right of reproduction.

On November 11, 2020, the SCNPC issued the amended Copyright Law of the People’s Republic of China (“**Amendment to the Copyright Law**”), which will be formally implemented on June 1, 2021.

Pursuant to the Measures for the Registration of Computer Software Copyright (《計算機軟件著作權登記辦法》) promulgated by the National Copyright Administration on February 20, 2002 and the Regulation on Computers Software Protection (《計算機軟件保護條例》) amended by the State Council on January 30, 2013 and came into effect on March 1, 2013, the National Copyright Administration (國家版權局) is mainly responsible for the registration and management of software copyright in China and recognizes the China Copyright Protection Centre (中國版權保護中心) as the software registration organization. The China Copyright Protection Centre shall grant certificates of registration to computer software copyright applicants in compliance with the regulations of the Measures for the Registration of Computer Software Copyright and the Regulation on Computers Software Protection.

Domain Name

According to the Measures for the Administration of Internet Domain Names (《互聯網域名管理辦法》) issued by the Ministry of Industry and Information Technology on August 24, 2017 and taking effect on November 1, 2017, setting up a domain name root server, a domain name root server operating institution, a domain name registration institution and a domain name registration service institution in China shall obtain permission from the Ministry of Industry and Information Technology or the communication administrative departments of province, autonomous region or municipality directly under the central government. The domain name registration services shall follow a “first to file” principle. The Notice on Regulating the Use of Domain Names in Internet Information Services (《關於規範互聯網信息服務使用域名的通知》) issued by the Ministry of Industry and Information Technology on November 27, 2017 and taking effect on January 1, 2018 stipulates on obligations of Internet information service providers and other entities, including anti-terrorism and maintenance of cyber security.

REGULATORY OVERVIEW

Regulations Relating to Foreign Investment

Foreign Investment

Investment activities in the PRC by foreign investors were principally governed by the Special Administrative Measures for the Access of Foreign Investment (Negative List) (2020 Version) (《外商投資准入特別管理措施(負面清單)(2020年版)》) (the “**Negative List**”) and the Catalogue of Industries for Encouraging Foreign Investment (2020 Version) (《鼓勵外商投資產業目錄(2020年版)》) (the “**Encouraging List**”). The Negative List, which came into effect on July 23, 2020, sets out special administrative measures in respect of the access of foreign investments in a centralized manner, and the Encouraging List which came into effect on January 27, 2021, specifies the encouraged industries for foreign investments.

Foreign Investment Enterprise

On December 29, 1993, the SCNPC promulgated the Company Law of the People’s Republic of China (《中華人民共和國公司法》) (newly amended on October 26, 2018). The incorporation, operation and management of corporate entities in the PRC shall be governed by the PRC Company Law and the companies shall be divided into limited liability companies and joint stock companies. The PRC Company Law shall be applicable to foreign-invested companies, unless otherwise specified by relevant laws.

According to the Foreign Investment Law of the People’s Republic of China (《中華人民共和國外商投資法》) promulgated by the SCNPC on March 15, 2019 and taking effect on January 1, 2020, the state implements pre-entry national treatment and negative list management system for foreign investment and provides national treatment to foreign investment outside the negative list. Simultaneously, the Sino-Foreign Equity Joint Venture Enterprises Law of the PRC (《中華人民共和國中外合資經營企業法》), the Wholly Foreign-Owned Enterprises Law of the PRC (《中華人民共和國外資企業法》) and the Chinese-Foreign Contractual Joint Venture Enterprise Law of the PRC (《中華人民共和國中外合作經營企業法》) have been repealed since January 1, 2020.

In December 2019, the State Council promulgated the Regulations on Implementing the Foreign Investment Law of the PRC (《中華人民共和國外商投資法實施條例》), which came into effect in January 2020. After the Regulations on Implementing the Foreign Investment Law of the PRC came into effect, the Regulation on Implementing the Sino-Foreign Equity Joint Venture Enterprise Law of the PRC (《中華人民共和國中外合資經營企業法實施條例》), Provisional Regulations on the Duration of Sino-Foreign Equity Joint Venture Enterprise Law (《中外合資經營企業合營期限暫行規定》), the Rules for the Implementation of the Wholly Foreign-Invested Enterprise Law of the PRC (《中華人民共和國外資企業法實施細則》) and the Rules for the Implementation of the Sino-foreign Contractual Joint Venture Enterprise Law of the PRC (《中華人民共和國中外合作經營企業法實施細則》) have been repealed simultaneously.

REGULATORY OVERVIEW

According to the Measures of the Reporting of Foreign Investment Information (《外商投資信息報告辦法》) (the “**Measures**”) which was promulgated by the Ministry of Commerce (商務部) (“**MOFCOM**”) and the State Administration for Market Regulation on December 30, 2019 and became effective on 1 January 2020, and replaced the Interim Measures for the Recordation Administration of the Establishment and Change of Foreign-invested Enterprises (《外商投資企業設立及變更備案管理暫行辦法》), for foreign investors carrying out investment activities directly or indirectly in PRC, the foreign investors or foreign-invested enterprises shall submit investment information to the commerce authorities pursuant to the Measures.

Regulations Relating to Foreign Exchange and Overseas Investment

On January 29, 1996, the State Council promulgated the Regulations on Foreign Exchange Administration of the PRC (《中華人民共和國外匯管理條例》) which became effective on April 1, 1996 and was amended on January 14, 1997 and August 5, 2008. According to the administrative provisions of the foreign exchange administrative department of the State Council on the payment and purchase of foreign currencies, the foreign exchange expenditure under current items shall, in accordance with the administrative provisions of the foreign exchange administrative department of the State Council on the payment and purchase of foreign exchange, be paid by an institution with its self-owned foreign exchange upon valid documents or with the foreign exchange purchased from any financial institution operating the foreign exchange sale or settlement business. Domestic institutions or individuals that make direct investments abroad, are engaged in the distribution, sale of valuable securities or derivative products overseas shall handle the registration formalities pursuant to the provisions of the foreign exchange administrative department of the State Council. Such institutions or individuals subject to prior approval or record-filing with relevant authorities shall complete the required approval or record-filing prior to foreign exchange registration.

On November 19, 2012, the State Administration of Foreign Exchange (國家外匯管理局) (“**SAFE**”) issued the Circular of the State Administration of Foreign Exchange on Further Improving and Adjusting Foreign Exchange Administration Policies for Direct Investment (《國家外匯管理局關於進一步改進和調整直接投資外匯管理政策的通知》) (the “**SAFE Circular 59**”), which took effect from December 17, 2012 and was amended on May 4, 2015, October 10, 2018 and partially abolished on December 30, 2019. The SAFE Circular 59 aims to simplify the foreign exchange procedure and promote the facilitation of investment and trade. Pursuant to Circular 59, the opening of various special purpose foreign exchange accounts, such as pre-establishment expenses accounts, foreign exchange capital accounts and guarantee accounts, the reinvestment of RMB proceeds derived by foreign investors in the PRC, and remittance of foreign exchange profits and dividends by a foreign-invested enterprise to its foreign shareholders no longer require the approval or verification of SAFE, and multiple capital accounts for the same entity may be opened in different provinces. Later, the SAFE promulgated the Circular on Further Simplifying and Improving Foreign Exchange Administration Policies for Direct Investment (《關於進一步簡化和改進直接投資外匯管理政策的通知》) in February 2015, which was partially abolished in December 2019 and prescribed that the bank instead of SAFE shall directly examine and handle foreign exchange registration

REGULATORY OVERVIEW

under domestic direct investment and foreign exchange registration under overseas direct investment, and the SAFE and its branches shall indirectly regulate the foreign exchange registration of direct investment through banks.

On May 10, 2013, the SAFE issued the Administrative Provisions on Foreign Exchange in Domestic Direct Investment by Foreign Investors (《外國投資者境內直接投資外匯管理規定》), which became effective on May 13, 2013, was amended on October 10, 2018 and partially abolished on December 30, 2019. It specifies that the administration by SAFE or its local branches over direct investment by foreign investors in the PRC shall be conducted by way of registration and banks shall process foreign exchange business relating to the direct investment in China based on the registration information provided by SAFE or its branches.

Pursuant to the Notice on Issues Concerning the Foreign Exchange Administration of Overseas Listing (《關於境外上市外匯管理有關問題的通知》) issued by the SAFE on December 26, 2014, the domestic companies shall register the overseas listed with the foreign exchange control bureau located at its registered address in 15 working days after completion of the overseas listing and issuance. The funds raised by the domestic companies through overseas listing may be repatriated to China or deposited overseas, provided that the intended use of the fund shall be consistent with the contents of the document and other public disclosure documents.

The Circular on Reforming the Management Approach regarding the Settlement of Foreign Capital of Foreign-invested Enterprise (《國家外匯管理局關於改革外商投資企業外匯資本金結匯管理方式的通知》), which was promulgated on March 30, 2015, came into effect on June 1, 2015 and partially abolished on December 30, 2019, foreign-invested enterprises could settle their foreign exchange capital on a discretionary basis according to the actual needs of their business operations. Whilst, foreign-invested enterprises are prohibited to use the foreign exchange capital settled in RMB: (i) for any expenditures beyond the business scope of the foreign invested enterprises or forbidden by laws and regulations; (ii) for direct or indirect securities investment; (iii) to provide entrusted loans (unless permitted in the business scope), repay loans between enterprises (including advances by third parties) or repay RMB bank loans that have been on lent to a third party; and (iv) to purchase real estate not for self-use purposes (save for real estate enterprises).

On October 23, 2019, SAFE promulgated the Notice on Further Facilitating Cross-Board Trade and Investment (《關於進一步促進跨境貿易投資便利化的通知》), which became effective on the same date (except for Article 8.2, which became effective on January 1, 2020). The notice cancelled restrictions on domestic equity investments made with capital funds by non-investing foreign-funded enterprises. In addition, restrictions on the use of funds for foreign exchange settlement of domestic accounts for the realization of assets have been removed and restrictions on the use and foreign exchange settlement of foreign investors' security deposits have been relaxed. Eligible enterprises in the pilot area are also allowed to use revenues under capital accounts, such as capital funds, foreign debts and overseas listing

REGULATORY OVERVIEW

revenues for domestic payments without providing materials to the bank in advance for authenticity verification on an item-by-item basis, while the use of funds should be true, in compliance with applicable rules and conforming to the current capital revenue management regulations.

Regulations Relating to Taxation

Enterprise income tax

The Enterprise Income Tax Law of PRC (《中華人民共和國企業所得稅法》) (the “**EIT Law**”) which was amended by the SCNPC and became effective on December 29, 2018, and the Implementation Rules for the Enterprise Income Tax Law of the PRC (《中華人民共和國企業所得稅法實施條例》) which was amended by the State Council and became effective on April 23, 2019, are the principal laws and regulations governing enterprise income tax in the PRC. According to the EIT Law and its Implementation Rules, enterprises are classified into resident enterprises and non-resident enterprises. Resident enterprises refer to enterprises that are legally established in the PRC, or are established under foreign laws but whose actual management bodies are located in the PRC. And non-resident enterprises refer to enterprises that are legally established under foreign laws and have set up institutions or sites in the PRC but with no actual management body in the PRC, or enterprises that have not set up institutions or sites in the PRC but have derived incomes from the PRC. A uniform income tax rate of 25% applies to all resident enterprises and non-resident enterprises that have set up institutions or sites in the PRC to the extent that such incomes are derived from their set-up institutions or sites in the PRC, or such income are obtained outside the PRC but have an actual connection with the set-up institutions or sites. And non-resident enterprises that have not set up institutions or sites in the PRC or have set up institutions or sites but the incomes obtained by the said enterprises have no actual connection with the set-up institutions or sites, shall pay enterprise income tax at the rate of 10% in relation to their income sources from the PRC.

Value-added Tax

The main Chinese laws and regulations governing value-added tax (“**VAT**”) are the Interim Regulations of the People’s Republic of China on Value-added Tax (《中華人民共和國增值稅暫行條例》) (promulgated by the State Council on December 13, 1993, taking effect on January 1, 1994 and amended on November 10, 2008, February 6, 2016 and November 19, 2017) and the Rules for the Implementation of the Provisional Regulations of the People’s Republic of China on Value-added Tax (《中華人民共和國增值稅暫行條例實施細則》) (promulgated by the Ministry of Finance (財政部) (“**MOF**”) on December 25, 1993 and taking effect on the same date, and amended on December 15, 2008 and October 28, 2011). Institutions and individuals engaged in the sales of goods, provision of processing and repair services and import of goods in the PRC are taxpayers of value-added tax and shall pay value-added tax in accordance with laws and regulations. The rate of VAT for sale of goods is 17% unless otherwise specified. With the VAT reforms in the PRC, the rate of VAT has been changed several times. The MOF (財政部) and the STA (國家稅務總局) issued the Notice of on Adjusting VAT Rates (《關於調整增值稅稅率的通知》) on April 4, 2018 to adjust the tax

REGULATORY OVERVIEW

rates of 17% and 11% applicable to any taxpayer’s VAT taxable sale or import of goods to 16% and 10%, respectively, this adjustment became effect on May 1, 2018. Subsequently, the MOF, the STA and the General Administration of Customs jointly issued the Announcement on Relevant Policies for Deepening the VAT Reform (《關於深化增值稅改革有關政策的公告》) on March 20, 2019 to make a further adjustment, which came into effect on April 1, 2019. The tax rate of 16% applicable to the VAT taxable sale or import of goods shall be adjusted to 13%, and the tax rate of 10% applicable thereto shall be adjusted to 9%.

HISTORY, DEVELOPMENT AND CORPORATE STRUCTURE

OVERVIEW

We are a pioneer in the diabetes management medical devices industry that innovates and integrates the treatment and monitoring of diabetes to reshape the diabetes management paradigm in China and globally. See “—Establishment and Development of Our Company—(1) Establishment of MicroTech Medical” for the founders of our Group.

BUSINESS DEVELOPMENT MILESTONES

The following table summarizes the key milestones in our business development:

Year	Milestone
2011	MicroTech Medical, being our predecessor, was established in the PRC
2013	We obtained the medical device registration certificate for our Blood Glucose Monitoring System
2014	MicroTech Medical, being our predecessor, was designated as the Key Diabetes Research Center in Zhejiang Province, China We initiated the clinical trial for Equil
2015	MicroTech Medical, being our predecessor, was recognized as a National High and New Tech Enterprise
2016	We completed the Series A financing in an aggregate amount of approximately RMB31 million
2017	We completed the Series B financing in an aggregate amount of RMB120 million We obtained the NMPA approval and CE marking for Equil
2018	We completed the Series C financing in an aggregate amount of RMB135.9 million We initiated clinical trial for AiDEX G7, being our first CGMS product
2020	We completed the Series D financing in an aggregate amount of approximately RMB513.2 million We obtained CE marking for AiDEX G7 We moved into our new plant facilities with an aggregate area of approximately 20,000 sq.m.
2021	We submitted a 510(k) premarket notification for Equil to the FDA We submitted the registration application to NMPA for AiDEX G7 and also successfully launched AiDEX G7 in Europe

HISTORY, DEVELOPMENT AND CORPORATE STRUCTURE

OUR SUBSIDIARY

Our Company is principally engaged in diabetes management and the research and development and manufacturing of related medical devices. MicroTech E-Commerce, our subsidiary, is principally engaged in the e-commerce business of online marketing and sales of the products of our Group.

MicroTech E-Commerce was established by our Company (as to 51% equity interest), Mr. Hu Hangyu (胡航宇) (as to 24.5% equity interest) and Ms. Xu Fangling (徐方玲) (as to 24.5% equity interest) as a limited liability company under the laws of the PRC on September 19, 2019. On August 12, 2020, a shareholders’ resolution of MicroTech E-Commerce was passed whereby Mr. Hu Hangyu and Ms. Xu Fangling agreed to transfer and the Company agreed to acquire the 24.5% equity interest held by each of Mr. Hu Hangyu and Ms. Xu Fangling in MicroTech E-Commerce. The consideration of each of the aforementioned transfers was nil as each of Mr. Hu Hangyu and Ms. Xu Fangling had not contributed capital into MicroTech E-Commerce as of August 12, 2020. The aforementioned transfers were completed on September 16, 2020 and MicroTech E-Commerce became the wholly-owned subsidiary of our Company on the same date.

ESTABLISHMENT AND DEVELOPMENT OF OUR COMPANY

(1) Establishment of MicroTech Medical

On January 20, 2011, our predecessor MicroTech Medical was established as a limited liability company under the laws of the PRC, with an initial registered capital of RMB27,780,000. The shareholding structure of MicroTech Medical upon establishment is set forth in the table below:

Shareholders	Registered capital subscribed for <i>(RMB)</i>	Corresponding equity interest in our Company <i>(%)</i>
Dr. Zheng	10,000,800	36.00
Hangzhou Ruili Technology Co., Ltd. (杭州瑞利科技有限公司) (“ Hangzhou Ruili ”)	9,445,200	34.00
Mr. Wang Chunjiang	5,278,200	19.00
Ms. Qiu Yifeng	1,111,200	4.00
The 715th Research Institute of China Shipbuilding Industry Corporation (中國船舶重工集團公司第七一五研究所) (“ 715th Research Institute ”)	833,400	3.00
Ms. Liu Yajun	555,600	2.00
Mr. Zhou Shenghao	555,600	2.00
Total	27,780,000	100.00

HISTORY, DEVELOPMENT AND CORPORATE STRUCTURE

(2) [REDACTED] Investments and Major Shareholding Changes of Our Company

The major shareholding changes of our Company are set out below:

(a) November 2013 Equity Transfer

Pursuant to separate equity transfer agreements dated November 5, 2013 entered into by the following transferees, respectively with Dr. Zheng as the transferor, the following transfers of equity interest in our Company were agreed:

<u>Transferors</u>	<u>Transferees</u>	Registered capital transferred (RMB)	Consideration (RMB)
Dr. Zheng	Hangzhou Ruili	2,656,000	2,656,000
	Mr. Wang Chunjiang	1,484,300	1,484,300
	Ms. Qiu Yifeng	312,500	312,500
	715th Research Institute	234,400	234,400
	Ms. Liu Yajun	156,200	156,200
	Mr. Zhou Shenghao	156,200	156,200

Upon the completion of the abovementioned equity transfers on November 29, 2013, the shareholding structure of our Company was as follows:

<u>Shareholders</u>	Registered capital (RMB)	Equity interest (%)
Hangzhou Ruili	12,101,200	43.56
Mr. Wang Chunjiang	6,762,500	24.34
Dr. Zheng	5,001,200	18.00
Ms. Qiu Yifeng	1,423,700	5.12
715th Research Institute	1,067,800	3.84
Ms. Liu Yajun	711,800	2.56
Mr. Zhou Shenghao	711,800	2.56
Total	27,780,000	100.00

(b) March 2014 Capital Increase

Pursuant to a shareholders’ resolution dated December 9, 2013, the then Shareholders of the Company agreed to increase the registered capital of the Company from RMB27,780,000 to RMB41,670,000, which were all subscribed by the then Shareholders.

HISTORY, DEVELOPMENT AND CORPORATE STRUCTURE

The respective subscription amount and consideration paid by the relevant subscribers were as follows:

<u>Subscribers</u>	Registered capital subscribed for	Consideration paid⁽¹⁾
	<i>(RMB)</i>	<i>(RMB)</i>
Hangzhou Ruili	2,066,600	2,066,600
715th Research Institute	182,300	182,300
Dr. Zheng	10,000,000	10,000,000
Mr. Wang Chunjiang	1,154,800	1,154,800
Ms. Qiu Yifeng	243,100	243,100
Ms. Liu Yajun	121,600	121,600
Mr. Zhou Shenghao	121,600	121,600
Total	13,890,000	13,890,000

Note:

- (1) Other than Dr. Zheng, who made the capital contribution in the amount of RMB10,000,000 in the form of intellectual property rights, all other subscribers made the capital contribution in the form of cash.

Upon completion of the abovementioned capital increase on March 13, 2014, the shareholding structure of our Company was as follows:

<u>Subscribers</u>	Registered capital subscribed for	Equity interest
	<i>(RMB)</i>	<i>(%)</i>
Dr. Zheng	15,001,200	36.00
Hangzhou Ruili	14,167,800	34.00
Mr. Wang Chunjiang	7,917,300	19.00
Ms. Qiu Yifeng	1,666,800	4.00
715th Research Institute	1,250,100	3.00
Ms. Liu Yajun	833,400	2.00
Mr. Zhou Shenghao	833,400	2.00
Total	41,670,000	100.00

HISTORY, DEVELOPMENT AND CORPORATE STRUCTURE

(c) 2016 Equity Transfers

Pursuant to a series of separate equity transfer agreements entered into by (among others) the then Shareholders of the Company in March, April and May 2016, respectively, Hangzhou Ruili, 715th Research Institute, Ms. Qiu Yifeng and Mr. Wang Chunjiang transferred all their equity interests in the Company to the other shareholders of the Company and other third parties. Pursuant to the aforementioned equity transfer agreements, the following transfers of equity interest in our Company were agreed:

Transferors	Transferees	Registered capital transferred (RMB)	Consideration (RMB)
Hangzhou Ruili ⁽¹⁾	Dr. Zheng	14,167,800	34,996,982
715th Research Institute ⁽¹⁾	Dr. Zheng	1,250,100	3,087,969
Ms. Qiu Yifeng ⁽²⁾	Ms. Lv Tengfei	833,400	1,600,000
	Ms. Tang Weizhi	833,400	1,600,000
Mr. Wang Chunjiang ⁽³⁾	Dr. Zheng	7,917,300	38,000,000

Notes:

- (1) These equity transfers were pursuant to separate equity transfer agreements dated March 14, 2016 entered into by Hangzhou Ruili and 715th Research Institute, respectively with Dr. Zheng, and were completed on March 29, 2016.
- (2) These equity transfers were pursuant to equity transfer agreements dated April 21, 2016 entered into by Ms. Lv Tengfei and Ms. Tang Weizhi, respectively with Ms. Qiu Yifeng, and were completed on April 27, 2016.
- (3) This equity transfer was pursuant to equity transfer agreements dated May 23, 2016 entered into by Mr. Wang Chunjiang and Dr. Zheng, and was completed on June 3, 2016.

Upon the completion of the abovementioned equity transfers, the shareholding structure of our Company was as follows:

Shareholders	Registered capital (RMB)	Equity interest (%)
Dr. Zheng	38,336,400	92.00
Ms. Liu Yajun	833,400	2.00
Mr. Zhou Shenghao	833,400	2.00
Ms. Lv Tengfei	833,400	2.00
Ms. Tang Weizhi	833,400	2.00
Total	41,670,000	100.00

HISTORY, DEVELOPMENT AND CORPORATE STRUCTURE

(d) Series A Financing (September 2016 Capital Increase)

Pursuant to (i) a capital injection agreement dated December 1, 2014 (as supplemented by a supplemental agreement dated on the same date) entered into by our Company, LAV Evergreen (Hong Kong) Co., Limited (“LAV”), Shanghai Li’an Venture Capital Center (Limited Partnership) (上海禮安創業投資中心(有限合夥)) (“Shanghai Li’an”), Shanghai Aijian Investment Partnership (Limited Partnership) (上海艾健投資合夥企業(有限合夥)) (“Shanghai Aijian”) and our then Shareholders (the “Series A Investment Agreement”) and (ii) a joint venture agreement dated July 26, 2016 entered into by LAV, Shanghai Li’an, Shanghai Aijian and the then Shareholders, the registered capital of our Company was increased from RMB41,670,000 to RMB55,560,000, and the aforementioned [REDACTED] Investors agreed to subscribe for the increased registered capital of RMB13,890,000 of our Company at a total consideration of RMB31,370,000 (the “Series A Financing”).

The respective subscription amount and consideration paid by the relevant [REDACTED] Investors were as follows:

Subscribers	Registered capital subscribed for <i>(RMB)</i>	Consideration paid <i>(RMB)</i>
LAV	8,102,500	18,299,167
Shanghai Li’an	3,858,333	8,713,889
Shanghai Aijian	1,929,167	4,356,944
Total	13,890,000	31,370,000

Upon completion of the Series A Financing on September 26, 2016, the shareholding structure of our Company was as follows:

Shareholders	Registered capital <i>(RMB)</i>	Equity interest <i>(%)</i>
Dr. Zheng	38,336,400	69.00
LAV	8,102,500	14.58
Shanghai Li’an	3,858,333	6.95
Shanghai Aijian	1,929,167	3.47
Ms. Liu Yajun	833,400	1.50
Mr. Zhou Shenghao	833,400	1.50
Ms. Lv Tengfei	833,400	1.50
Ms. Tang Weizhi	833,400	1.50
Total	55,560,000	100.00

HISTORY, DEVELOPMENT AND CORPORATE STRUCTURE

(e) Series B Financing (February 2017 Capital Increase and Equity Transfers)

Pursuant to a capital increase and equity transfer agreement dated November 1, 2016 (the “**Series B Capital Increase and Equity Transfer Agreement**”) (as supplemented by a supplemental agreement dated on the same date) entered into by our Company, Suzhou Qiming Ronghe Venture Capital Partnership (Limited Partnership) (蘇州啟明融合創業投資合夥企業(有限合夥)) (“**Suzhou Qiming**”), QM32 Limited (“**QM32**”), Hangzhou Zibo Investment Management Partnership (Limited Partnership) (杭州紫博投資管理合夥企業(有限合夥)) (“**Hangzhou Zibo**”), Shenzhen Zijingang Innovation Industry Investment Enterprise (Limited Partnership) (深圳紫金港創新產業投資企業(有限合夥)) (“**Shenzhen Zijingang**”), Hangzhou Jiuyao Equity Investment Partnership (Limited Partnership) (杭州九瑛股權投資合夥企業(有限合夥)) (Previously known as Haining Jiuyao Equity Investment Partnership (Limited Partnership) (海寧九曜股權投資合夥企業(有限合夥)) (“**Hangzhou Jiuyao**”), Hangzhou Jiufu Equity Investment Partnership (Limited Partnership) (杭州九賦股權投資合夥企業(有限合夥)) (“**Hangzhou Jiufu**”), Hangzhou Chende Investment Partnership (Limited Partnership) (杭州辰德投資合夥企業(有限合夥)) (“**Hangzhou Chende**”), Power SUM Limited (“**Power SUM**”), Hangzhou Haibang Pharmaceutical Valley Congzheng Venture Capital Partnership (Limited Partnership) (杭州海邦藥谷從正創業投資合夥企業(有限合夥)) (“**Hangzhou Haibang**”) and our then Shareholders, the registered capital of our Company was increased from RMB55,560,000 to RMB66,860,339.

The following [REDACTED] Investors agreed to subscribe for the increased registered capital of RMB11,300,339 of our Company at a consideration of RMB120,000,000 and the respective subscription amount and consideration paid by the relevant [REDACTED] Investors were as follows:

Subscribers	Registered capital subscribed for (RMB)	Consideration paid (RMB)	Corresponding equity interest in our Company (upon completion of the Series A Financing) (%)
QM32	7,062,712	75,000,000 ⁽¹⁾	10.56
Hangzhou Haibang	1,883,390	20,000,000	2.82
Hangzhou Chende	1,412,542	15,000,000	2.11
Hangzhou Jiufu	941,695	10,000,000	1.41
Total	11,300,339	120,000,000	16.90

Note:

(1) Paid in USD equivalent to RMB75,000,000.

HISTORY, DEVELOPMENT AND CORPORATE STRUCTURE

Pursuant to the Series B Capital Increase and Equity Transfer Agreement and separate equity transfer agreements dated November 1, 2016, the following transfers of equity interest in our Company were also agreed:

Transferors	Transferees	Registered capital transferred <i>(RMB)</i>	Consideration <i>(RMB)</i>
Dr. Zheng	Suzhou Qiming	3,691,444	39,200,000
	Hangzhou Jiuyao	2,825,085	30,000,000
	Hangzhou Jiufu	1,883,390	20,000,000
	Hangzhou Zibo	1,506,712	16,000,000
	Shenzhen Zijingang	941,695	10,000,000
	Power SUM	915,328	9,720,004 ⁽¹⁾
	Dore Chin Mark ⁽²⁾	2,584,952	nil

Notes:

- (1) Paid in USD equivalent to RMB9,720,004.
- (2) Dore Chin Mark is the vice president of our Company and has been a core R&D team member since he joined our Company in March 2011. Therefore, Dr. Zheng, the chairman of our Board, transferred a total of RMB2,584,952 registered capital in our Company to Dore Chin Mark for nil consideration as gratitude for his contribution for the Company.

Upon completion of the abovementioned transfers and capital increase on February 14, 2017, the shareholding structure of our Company was as follows:

Shareholders	Registered capital <i>(RMB)</i>	Equity interest <i>(%)</i>
Dr. Zheng	23,987,794	35.88
LAV	8,102,500	12.12
QM32	7,062,712	10.56
Shanghai Li'an	3,858,333	5.77
Suzhou Qiming	3,691,444	5.52
Hangzhou Jiuyao	2,825,085	4.23
Hangzhou Jiufu	2,825,085	4.23
Dore Chin Mark	2,584,952	3.87
Shanghai Aijian	1,929,167	2.89
Hangzhou Haibang	1,883,390	2.82
Hangzhou Zibo	1,506,712	2.25
Hangzhou Chende	1,412,542	2.11
Shenzhen Zijingang	941,695	1.41
Power SUM	915,328	1.37
Ms. Liu Yajun	833,400	1.25
Mr. Zhou Shenghao	833,400	1.25
Ms. Lv Tengfei	833,400	1.25
Ms. Tang Weizhi	833,400	1.25
Total	66,860,339	100.00

HISTORY, DEVELOPMENT AND CORPORATE STRUCTURE

(f) February 2018 Capital Increase by Hangzhou Yantai and Equity Transfer

Pursuant to a Board resolution of our Company dated December 25, 2017, the registered capital of our Company was increased from RMB66,860,339 to RMB71,892,838 and Hangzhou Yantai agreed to subscribe for the increased registered capital of RMB5,032,499 of our Company at a consideration of RMB5,032,499. On the same date, an equity transfer agreement was entered into by Dore Chin Mark and Power SUM, pursuant to which Dore Chin Mark agreed to transfer and Power SUM agreed to acquire a total of RMB750,282 registered capital of the Company at a consideration of RMB7,967,995.

Hangzhou Yantai was established as a limited partnership under the laws of the PRC on January 2, 2018. For the details on Hangzhou Yantai, see “Employee Incentive Schemes—Hangzhou Yantai.”

Upon completion of the abovementioned equity transfer and the capital increase on February 8, 2018, the shareholding structure of our Company was as follows:

Shareholders	Registered capital (RMB)	Equity interest (%)
Dr. Zheng	23,987,794	33.37
LAV	8,102,500	11.27
QM32	7,062,712	9.82
Hangzhou Yantai	5,032,499	7.00
Shanghai Li'an	3,858,333	5.37
Suzhou Qiming	3,691,444	5.13
Hangzhou Jiuyao	2,825,085	3.93
Hangzhou Jiufu	2,825,085	3.93
Shanghai Aijian	1,929,167	2.68
Hangzhou Haibang	1,883,390	2.62
Dore Chin Mark	1,834,670	2.55
Power SUM	1,665,610	2.32
Hangzhou Zibo	1,506,712	2.10
Hangzhou Chende	1,412,542	1.96
Shenzhen Zijingang	941,695	1.31
Ms. Liu Yajun	833,400	1.16
Mr. Zhou Shenghao	833,400	1.16
Ms. Lv Tengfei	833,400	1.16
Ms. Tang Weizhi	833,400	1.16
Total	71,892,838	100.00

HISTORY, DEVELOPMENT AND CORPORATE STRUCTURE

(g) Series C Financing (December 2018 Capital Increase and Equity Transfers)

Pursuant to a capital increase agreement dated December 26, 2018 and an investment agreement dated December 8, 2018 (together, the “**Series C Capital Increase and Investment Agreements**”) entered into by and amongst Jiangsu Jiequan Lize Health Industry Venture Capital Fund (Limited Partnership) (江蘇惠泉醴澤健康產業創業投資基金(有限合夥)) (“**Jiangsu Jiequan**”), Jiaxing Furui Equity Investment Partnership (Limited Partnership) (嘉興福銳股權投資合夥企業(有限合夥)) (“**Jiaxing Furui**”), Hangzhou Yunbo Investment Partnership (Limited Partnership) (杭州雲帛投資合夥企業(有限合夥)) (“**Hangzhou Yunbo**”), Hangzhou Jiuge Equity Investment Partnership (Limited Partnership) (杭州九歌股權投資合夥企業(有限合夥)) (“**Hangzhou Jiuge**”), Shanghai Guofang Master Fund Phase I Venture Capital Investment Partnership (Limited Partnership) (上海國方母基金一期創業投資合夥企業(有限合夥)) (formerly known as Shanghai Guofang Master Fund Phase I Equity Investment Partnership (Limited Partnership) (上海國方母基金一期股權投資合夥企業(有限合夥)) (“**Shanghai Guofang I**”), Shanghai Guofang Master Fund Phase II Venture Capital Investment Partnership (Limited Partnership) (上海國方母基金二期創業投資合夥企業(有限合夥)) (formerly known as Shanghai Guofang Master Fund Phase II Equity Investment Partnership (Limited Partnership) (上海國方母基金二期股權投資合夥企業(有限合夥)) (“**Shanghai Guofang II**”), Shanghai Tongfanghui Business Consulting Partnership (Limited Partnership) (上海潼方匯商務諮詢合夥企業(有限合夥)) (“**Shanghai Tongfanghui**”, collectively with Shanghai Guofang I and Shanghai Guofang II called “**Guofang Master Fund**”), QM32 (together, the “**Series C [REDACTED] Investors**”), our Company and our then Shareholders, the registered capital of our Company was increased from RMB71,892,838 to RMB78,871,579.

The following Series C [REDACTED] Investors agreed to subscribe for the increased registered capital of RMB6,978,741 of our Company at a total consideration of RMB135,900,000 (the “**Series C Financing**”) and the respective subscription amount and consideration paid by the relevant Series C [REDACTED] Investors were as follows:

Subscribers	Registered capital subscribed for <i>(RMB)</i>	Consideration paid <i>(RMB)</i>
Jiangsu Jiequan	3,594,642	70,000,000
Shanghai Guofang I	1,916,073	37,312,500
Shanghai Guofang II	638,691	12,437,500
Shanghai Tongfanghui	12,838	250,000
Hangzhou Yunbo	462,168	9,000,000
QM32	354,329	6,900,000 ⁽¹⁾
Total	6,978,741	135,900,000

Note:

(1) Paid in USD equivalent to RMB6,900,000.

HISTORY, DEVELOPMENT AND CORPORATE STRUCTURE

Pursuant to the Series C Capital Increase and Investment Agreements and separate equity transfer agreements dated December 8, 2018, the following transfers of equity interest in our Company were also agreed:

Transferors	Transferees	Registered capital transferred (RMB)	Consideration (RMB)
Ms. Tang Weizhi	Hangzhou Jiuge	332,285	5,500,000
LAV	Jiaxing Furui	483,324	8,000,000
LAV	Hangzhou Jiuge	422,908	7,000,000
LAV	QM32	416,867	6,900,000
Shanghai Li'an	Jiangsu Jiequan	689,403	11,411,040
Ms. Lv Tengfei	Jiangsu Jiequan	289,661	4,794,480
Ms. Lv Tengfei	Hangzhou Yunbo	543,739	9,000,000
Ms. Liu Yajun	Jiangsu Jiequan	833,400	13,794,480

Upon completion of the abovementioned equity transfers on December 26, 2018 and the capital increase on December 29, 2018, the shareholding structure of our Company was as follows:

Shareholders	Registered capital (RMB)	Equity interest (%)
Dr. Zheng	23,987,794	30.41
QM32	7,833,908	9.93
LAV	6,779,401	8.59
Jiangsu Jiequan	5,407,106	6.86
Hangzhou Yantai	5,032,499	6.38
Suzhou Qiming	3,691,444	4.68
Shanghai Li'an	3,168,930	4.02
Hangzhou Jiufu	2,825,085	3.58
Hangzhou Jiuyao	2,825,085	3.58
Shanghai Aijian	1,929,167	2.44
Shanghai Guofang I	1,916,073	2.43
Hangzhou Haibang	1,883,390	2.39
Dore Chin Mark	1,834,670	2.33
Power SUM	1,665,610	2.11
Hangzhou Zibo	1,506,712	1.91
Hangzhou Chende	1,412,542	1.79
Hangzhou Yunbo	1,005,907	1.28
Shenzhen Zijingang	941,695	1.19
Mr. Zhou Shenghao	833,400	1.06
Hangzhou Jiuge	755,193	0.96
Shanghai Guofang II	638,691	0.81
Ms. Tang Weizhi	501,115	0.64
Jiaxing Furui	483,324	0.61
Shanghai Tongfanghui	12,838	0.02
Total	78,871,579	100.00

HISTORY, DEVELOPMENT AND CORPORATE STRUCTURE

(h) June 2019 Equity Transfer

Pursuant to an equity transfer agreement dated May 28, 2019, Shenzhen Zijingang agreed to transfer and Dr. Zheng agreed to acquire a total of RMB941,695 registered capital of the Company at a consideration of RMB13,100,000.

Upon completion of the abovementioned equity transfer on June 4, 2019, the shareholding structure of our Company was as follows:

Shareholders	Registered capital (RMB)	Equity interest (%)
Dr. Zheng	24,929,489	31.60
QM32	7,833,908	9.93
LAV	6,779,401	8.59
Jiangsu Jiequan	5,407,106	6.86
Hangzhou Yantai	5,032,499	6.38
Suzhou Qiming	3,691,444	4.68
Shanghai Li'an	3,168,930	4.02
Hangzhou Jiufu	2,825,085	3.58
Hangzhou Jiuyao	2,825,085	3.58
Shanghai Aijian	1,929,167	2.44
Shanghai Guofang I	1,916,073	2.43
Hangzhou Haibang	1,883,390	2.39
Dore Chin Mark	1,834,670	2.33
Power SUM	1,665,610	2.11
Hangzhou Zibo	1,506,712	1.91
Hangzhou Chende	1,412,542	1.79
Hangzhou Yunbo	1,005,907	1.28
Mr. Zhou Shenghao	833,400	1.06
Hangzhou Jiuge	755,193	0.96
Shanghai Guofang II	638,691	0.81
Ms. Tang Weizhi	501,115	0.64
Jiaxing Furui	483,324	0.61
Shanghai Tongfanghui	12,838	0.02
Total	78,871,579	100.00

HISTORY, DEVELOPMENT AND CORPORATE STRUCTURE

(i) *December 2019 Capital Increase by Hangzhou Hengtai*

Pursuant to a capital increase agreement dated December 25, 2019 entered into by Hangzhou Hengtai and our then Shareholders, the registered capital of our Company was increased from RMB78,871,579 to RMB83,022,715, and Hangzhou Hengtai agreed to subscribe for the increased registered capital of RMB4,151,136 of our Company at a total consideration of RMB4,151,136.

Hangzhou Hengtai was established as a limited partnership under the laws of the PRC on December 11, 2019. For the details on Hangzhou Hengtai, see “Employee Incentive Schemes—Hangzhou Hengtai.”

Upon completion of the abovementioned capital increase on December 25, 2019, the shareholding structure of our Company was as follows:

Shareholders	Registered capital (RMB)	Equity interest (%)
Dr. Zheng	24,929,489	30.03
QM32	7,833,908	9.44
LAV	6,779,401	8.17
Jiangsu Jiequan	5,407,106	6.51
Hangzhou Yantai	5,032,499	6.06
Hangzhou Hengtai	4,151,136	5.00
Suzhou Qiming	3,691,444	4.45
Shanghai Li'an	3,168,930	3.82
Hangzhou Jiufu	2,825,085	3.40
Hangzhou Jiuyao	2,825,085	3.40
Shanghai Aijian	1,929,167	2.32
Shanghai Guofang I	1,916,073	2.31
Hangzhou Haibang	1,883,390	2.27
Dore Chin Mark	1,834,670	2.21
Power SUM	1,665,610	2.01
Hangzhou Zibo	1,506,712	1.81
Hangzhou Chende	1,412,542	1.70
Hangzhou Yunbo	1,005,907	1.21
Mr. Zhou Shenghao	833,400	1.00
Hangzhou Jiuge	755,193	0.91
Shanghai Guofang II	638,691	0.77
Ms. Tang Weizhi	501,115	0.60
Jiaxing Furui	483,324	0.58
Shanghai Tongfanghui	12,838	0.02
Total	83,022,715	100.00

HISTORY, DEVELOPMENT AND CORPORATE STRUCTURE

(j) June 2020 Equity Transfer

Pursuant to separate equity transfer agreements dated May 7, 2020, the following transfers of equity interest in our Company were agreed:

Transferors	Transferees	Registered capital transferred <i>(RMB)</i>	Consideration <i>(RMB)</i>
Shanghai Guofang I	Shanghai Guofang Zouzhen Enterprise Service Center (Limited Partnership) (上海國方奏臻企業服務 中心(有限合夥)) (Formerly known as Shanghai Zouzhen Enterprise Service Center (Limited Partnership) (上海奏臻 企業服務中心(有限合 夥)) (“ Shanghai Zouzhen ”)	1,916,073	37,312,500
Shanghai Guofang II	Shanghai Zouzhen	638,691	12,437,500
Shanghai Tongfanghui	Shanghai Zouzhen	12,838	250,000
Mr. Zhou Shenghao	Suzhou Likang Equity Investment Center(Limited Partnership) (蘇州禮康 股權投資中心(有限合 夥)) (“ Suzhou Likang ”)	522,935	9,259,078
Mr. Zhou Shenghao	Jiangsu Jiequan	310,465	5,497,100
Ms. Tang Weizhi	Jiangsu Jiequan	501,115	8,872,741
Hangzhou Haibang	QM32	1,175,832	20,819,273
Hangzhou Haibang	Suzhou Qiming	554,068	9,810,324
Hangzhou Haibang	Mr. Zhu Liuping	153,490	2,717,702
Shanghai Aijian	Mr. Zhu Liuping	958,905	16,978,374
Shanghai Aijian	Suzhou Likang	970,262	17,179,452

HISTORY, DEVELOPMENT AND CORPORATE STRUCTURE

(k) September 2020 Equity Transfer

On September 22, 2020, the following parties entered into separate equity transfer agreements, respectively, pursuant to which the following transfers of equity interest in our Company were agreed:

Transferors	Transferees	Registered capital transferred (RMB)	Consideration (RMB)
Dr. Zheng	QM153 Limited (“QM153”)	755,507	28,665,000 ⁽¹⁾
Dr. Zheng	Suzhou Likang	655,879	24,885,000
Dr. Zheng	Power SUM	174,348	6,615,000 ⁽²⁾

Notes:

(1) Paid in USD equivalent to RMB28,665,000.

(2) Paid in USD equivalent to RMB6,615,000.

Upon completion of the abovementioned June 2020 equity transfer and September 2020 equity transfer on June 2, 2020 and September 29, 2020, the shareholding structure of our Company was as follows:

Shareholders	Registered capital (RMB)	Equity interest (%)
Dr. Zheng	23,343,755	28.12
QM32	9,009,740	10.85
LAV	6,779,401	8.17
Jiangsu Jiequan	6,218,686	7.49
Hangzhou Yantai	5,032,499	6.06
Suzhou Qiming	4,245,512	5.11
Hangzhou Hengtai	4,151,136	5.00
Shanghai Li'an	3,168,930	3.82
Hangzhou Jiuyao	2,825,085	3.40
Hangzhou Jiufu	2,825,085	3.40
Shanghai Zouzhen	2,567,602	3.10
Suzhou Likang	2,149,076	2.59
Dore Chin Mark	1,834,670	2.21
Power SUM	1,839,958	2.22
Hangzhou Zibo	1,506,712	1.81
Hangzhou Chende	1,412,542	1.70
Mr. Zhu Liuping	1,112,395	1.34
Hangzhou Yunbo	1,005,907	1.21
QM153	755,507	0.91
Hangzhou Jiuge	755,193	0.91
Jiaxing Furui	483,324	0.58
Total	83,022,715	100.00

HISTORY, DEVELOPMENT AND CORPORATE STRUCTURE

(l) Conversion into a joint stock limited company

On October 15, 2020, our Board passed resolutions approving, among other matters, the conversion of our Company from a limited liability company into a joint stock limited company and the change of name of our Company from MicroTech Medical (Hangzhou) Company Limited (微泰醫療器械(杭州)有限公司) to MicroTech Medical (Hangzhou) Co., Ltd. (微泰醫療器械(杭州)股份有限公司). Pursuant to the promoters’ agreement dated October 15, 2020 entered into by all the then Shareholders, all promoters approved the conversion of RMB83,022,715 in the net assets value of our Company as of September 30, 2020 into 83,022,715 Shares of our Company. On October 30, 2020, our Company convened our founding meeting, being the first extraordinary general meeting of our Company in 2020, and passed related resolutions approving the conversion of our Company into a joint stock limited company, the articles of association and the relevant internal rules. Upon completion of the conversion, the registered capital of our Company became RMB83,022,715 divided into 83,022,715 Shares with a nominal value of RMB1.0 each, which were subscribed by all the then Shareholders in proportion to their respective equity interests in our Company before the conversion. The conversion was completed on November 6, 2020 when our Company obtained a new business license.

(m) Series D Financing (November 2020 Capital Increase)

Pursuant to an investment agreement dated November 8, 2020 entered into by and amongst Zhangjiagang Taikang Qianzhen Equity Investment Partnership (Limited Partnership) (張家港泰康乾貞股權投資合夥企業(有限合夥)) (“**Taikang Qianzhen**”), Shenzhen Tencent Information Technology Co., Ltd. (深圳市騰訊信息技術有限公司) (“**Shenzhen Tencent**”), Zhuhai Yitai Management Consulting Enterprise (Limited Partnership) (珠海屹泰管理諮詢企業(有限合夥)) (“**Zhuhai Yitai**”), Suzhou Chenzhide Investment Partnership (Limited Partnership) (蘇州辰知德投資合夥企業(有限合夥)) (“**Suzhou Chenzhide**”), Nanjing Jianye Sanzheng Shunxin Equity Investment Partnership (Limited Partnership) (南京建鄴叁正順心股權投資合夥企業(有限合夥)) (“**Nanjing Sanzheng**”), CICC Pucheng Investment Co., Ltd. (中金浦成投資有限公司) (“**CICC Pucheng**”), Shanghai Guangkong Guanghai Equity Investment Center (Limited Partnership) (上海光控光海股權投資中心(有限合夥)) (“**Shanghai Guangkong**”), Mr. Teng Rongsong (滕榮松), our then Shareholders and the Company, the registered capital of our Company was increased from RMB83,022,715 to RMB95,195,805, and the abovementioned [REDACTED] investors agreed to subscribe for the increased registered capital of RMB12,173,090 of our Company at a total consideration of RMB513,180,000 (the “**Series D Financing**”).

HISTORY, DEVELOPMENT AND CORPORATE STRUCTURE

The respective subscription amount and consideration paid by the relevant [REDACTED] Investors were as follows:

Subscribers	Registered capital subscribed for <i>(RMB)</i>	Consideration paid <i>(RMB)</i>
Taikang Qianzhen	3,558,126	150,000,000
Shenzhen Tencent	2,372,080	100,000,000
Zhuhai Yitai	1,897,671	80,000,000
QM153	1,058,192	44,610,000 ⁽¹⁾
Nanjing Sanzheng	474,421	20,000,000
CICC Pucheng	474,421	20,000,000
Mr. Teng Rongsong	474,421	20,000,000
Shanghai Guangkong	474,421	20,000,000
Suzhou Chenzhide	474,421	20,000,000
Shanghai Zouzhen	474,421	20,000,000
Suzhou Likang	440,495	18,570,000
Total	12,173,090	513,180,000

Note:

(1) Paid in USD equivalent to RMB44,610,000.

Upon completion of the Series D Financing on November 23, 2020, the shareholding structure of our Company was as follows:

Shareholders	Number of Shares held	Equity interest <i>(%)</i>
Dr. Zheng	23,343,755	24.52
QM32	9,009,740	9.46
LAV	6,779,401	7.12
Jiangsu Jiequan	6,218,686	6.53
Hangzhou Yantai	5,032,499	5.29
Suzhou Qiming	4,245,512	4.46
Hangzhou Hengtai	4,151,136	4.36
Taikang Qianzhen	3,558,126	3.74
Shanghai Li'an	3,168,930	3.33
Shanghai Zouzhen	3,042,023	3.20
Hangzhou Jiuyao	2,825,085	2.97
Hangzhou Jiufu	2,825,085	2.97
Suzhou Likang	2,589,571	2.72
Shenzhen Tencent	2,372,080	2.49
Zhuhai Yitai	1,897,671	1.99

HISTORY, DEVELOPMENT AND CORPORATE STRUCTURE

Shareholders	Number of Shares held	Equity interest (%)
Power SUM	1,839,958	1.93
Dore Chin Mark	1,834,670	1.93
QM153	1,813,699	1.91
Hangzhou Zibo	1,506,712	1.58
Hangzhou Chende	1,412,542	1.48
Mr. Zhu Liuping	1,112,395	1.17
Hangzhou Yunbo	1,005,907	1.06
Hangzhou Jiuge	755,193	0.79
Jiaxing Furui	483,324	0.51
Suzhou Chenzhide	474,421	0.50
Nanjing Sanzheng	474,421	0.50
CICC Pucheng	474,421	0.50
Mr. Teng Rongsong	474,421	0.50
Shanghai Guangkong	474,421	0.50
Total	95,195,805	100.00

(n) December 2020 Capital Increase

Pursuant to a shareholders’ resolution of our Company dated December 9, 2020, the registered capital of our Company was increased from RMB95,195,805 to RMB360,000,000. The increased registered capital of RMB264,804,195 was all converted from the capital reserves of our Company. The abovementioned capital increase was completed on December 18, 2020.

Upon completion of the abovementioned capital increase on December 18, 2020, the shareholding structure of our Company was as follows:

Shareholders	Number of Shares held	Equity interest (%)
Dr. Zheng	88,278,594	24.52
QM32	34,071,947	9.46
LAV	25,637,520	7.12
Jiangsu Jiequan	23,517,076	6.53
Hangzhou Yantai	19,031,297	5.29
Suzhou Qiming	16,055,165	4.46
Hangzhou Hengtai	15,698,265	4.36
Taikang Qianzhen	13,455,691	3.74

HISTORY, DEVELOPMENT AND CORPORATE STRUCTURE

Shareholders	Number of Shares held	Equity interest (%)
Shanghai Li'an	11,983,877	3.33
Shanghai Zouzhen	11,503,955	3.20
Hangzhou Jiuyao	10,683,565	2.97
Hangzhou Jiufu	10,683,565	2.97
Suzhou Likang	9,792,927	2.72
Shenzhen Tencent	8,970,446	2.49
Zhuhai Yitai	7,176,383	1.99
Power SUM	6,958,131	1.93
Dore Chin Mark	6,938,133	1.93
QM153	6,858,828	1.91
Hangzhou Zibo	5,697,901	1.58
Hangzhou Chende	5,341,781	1.48
Mr. Zhu Liuping	4,206,721	1.17
Hangzhou Yunbo	3,804,018	1.06
Hangzhou Jiuge	2,855,898	0.79
Jiaxing Furui	1,827,776	0.51
Suzhou Chenzhide	1,794,108	0.50
Nanjing Sanzheng	1,794,108	0.50
CICC Pucheng	1,794,108	0.50
Mr. Teng Rongsong	1,794,108	0.50
Shanghai Guangkong	1,794,108	0.50
Total	360,000,000	100.00

EMPLOYEE INCENTIVE SCHEMES

In recognition of the contributions of our employees and to incentivize them to further promote our development, Hangzhou Yantai and Hangzhou Hengtai were established in the PRC as our Employee Incentive Platforms.

1. Hangzhou Yantai

Hangzhou Yantai was established as a limited partnership established in the PRC on January 2, 2018. Dr. Zheng is the sole general partner of Hangzhou Yantai and is responsible for the management of Hangzhou Yantai. As of the Latest Practicable Date, Hangzhou Yantai held approximately 5.29% equity interest in our Company. For the details on Hangzhou Yantai, see “Appendix VI—Statutory and General Information—Further Information about Our Directors, Supervisors, Senior Management and Substantial Shareholders—5. Employee Incentive Schemes.”

HISTORY, DEVELOPMENT AND CORPORATE STRUCTURE

2. Hangzhou Hengtai

Hangzhou Hengtai was established as a limited partnership established in the PRC on December 11, 2019. Dr. Zheng is the sole general partner of Hangzhou Hengtai and is responsible for the management of Hangzhou Hengtai. As of the Latest Practicable Date, Hangzhou Hengtai held approximately 4.36% equity interest in our Company. For the details on Hangzhou Hengtai, see “Appendix VI—Statutory and General Information—Further Information about Our Directors, Supervisors, Senior Management and Substantial Shareholders—5. Employee Incentive Schemes.”

DETAILED TERMS OF THE [REDACTED] INVESTMENTS

1. Overview

Between September 2016 and November 2020, our Company obtained several rounds of investments from the [REDACTED] Investors through subscriptions for increased registered capital of our Company. For further details, see the subsection headed “Establishment and Development of Our Company” in this section.

2. Principal terms of the [REDACTED] Investments and [REDACTED] Investors’ Rights

The following table summarizes the key terms of the [REDACTED] Investments to our Company made by the [REDACTED] Investors:

	Series A	Series B	Series C	Series D
Amount of registered capital increased (RMB)	13,890,000	11,300,339	6,978,741	12,173,090
Amount of registered capital after each round of [REDACTED] Investments (RMB)	55,560,000	66,860,339	78,871,579	95,195,805
Amount of consideration paid (RMB)	31,370,000	120,000,000	135,900,000	513,180,000
Post-money valuation of our Company (approximation) (RMB)	125,480,000	710,000,000 ⁽¹⁾	1,535,900,000 ⁽²⁾	4,013,171,800 ⁽³⁾⁽⁴⁾
Date of agreements	December 1, 2014 and July 26, 2016	November 1, 2016	December 8, 2018	November 8, 2020
Date of payment of full consideration	January 8, 2015	December 15, 2016	January 30, 2019	December 16, 2020

HISTORY, DEVELOPMENT AND CORPORATE STRUCTURE

	Series A	Series B	Series C	Series D
Cost per Share paid under the [REDACTED] Investments ⁽⁵⁾ (approximation) (RMB)	0.60	2.81	5.15	11.15
Discount to the [REDACTED] ⁽⁶⁾ (approximation)	[REDACTED]%	[REDACTED]%	[REDACTED]%	[REDACTED]%
Basis of determination of the valuation and consideration	The valuation and considerations for each round of [REDACTED] Investments were determined based on arm’s length negotiation amongst the respective [REDACTED] Investors and our Group after taking into consideration of the timing of the investments and the status of our business operations and clinical trials.			
Lock-up Period	Pursuant to the applicable PRC law, within the 12 months following the [REDACTED], all current Shareholders (including the [REDACTED] Investors) could not dispose of any of the Shares held by them.			
Use of [REDACTED] from the [REDACTED] Investments	We utilized the [REDACTED] from the [REDACTED] Investments for the principal business of our Group, including but not limited to research and development activities, the growth and expansion of our Company’s business and general working capital purposes. As of the Latest Practicable Date, approximately 42% of the net [REDACTED] from the [REDACTED] Investments had been utilized.			
Strategic benefits to our Company brought by the [REDACTED] Investors	At the time of the [REDACTED] Investments, our Directors were of the view that our Group could benefit from the additional funds provided by the [REDACTED] Investors’ investments in our Group and the knowledge and experience of the [REDACTED] Investors.			

Notes:

1. The increase from the post-money valuation of Series A Financing to the pre-money valuation of Series B Financing was mainly because we had a number of milestones for our products during the period between the two financings. For example, we (i) completed the clinical trial for Equil and (ii) applied for registration with NMPA and CE marking for Equil, both of which were pending approval during the period.
2. The increase from the post-money valuation of Series B Financing to the pre-money valuation of Series C Financing was mainly because we had a number of milestones for our products during the period between the two financings. For example, (i) we successfully launched Equil in China and Europe and (ii) we passed type testing and initiated the clinical trial for AiDEX G7.
3. The increase from the post-money valuation of Series C Financing to the pre-money valuation of Series D Financing was mainly because we had a number of milestones for our products during the period between the two financings. For example, (i) we completed the clinical trial and obtained CE marking for AiDEX G7 and (ii) we started our R&D projects in developing the second-generation patch insulin pump system and AiDEX X during the period.
4. Our anticipated [REDACTED] immediately upon completion of the [REDACTED] has primarily taken into account (a) the post-money valuation of the Series D Financing; (b) the expected capital raising during the [REDACTED]; (c) our business growth since completion of the Series D Financing in December 2020, and (d) the difference in risks undertaken by the [REDACTED] investors investing in a private company vis-à-vis investors investing in a [REDACTED] company. Subsequent to completion of the Series D Financing, we have continued to advance in the R&D, manufacturing and commercialization of our products. In particular, the NMPA accepted our registration application of CGMS in the first quarter of 2021 and we expect to obtain the NMPA approval in the second half of 2021. Shortly after AiDEX G7 obtained CE marking in September 2020, we completed the first shipment of AiDEX G7 to Europe in 2021. The continuous progress of our Group is expected to support the step-up in the proposed [REDACTED] valuation of our Group.
5. The cost per Share is adjusted with reference to (i) the conversion of our Company from a limited liability company to a joint stock limited company in November 2020 as set out in “Establishment and Development of Our Company—(2) [REDACTED] Investments and Major Shareholding Changes of

HISTORY, DEVELOPMENT AND CORPORATE STRUCTURE

Our Company—(l) Conversion into a joint stock limited company”, and (ii) the conversion of capital reserve to registered capital of our Company in December 2020 as set out in “Establishment and Development of Our Company—(2) [REDACTED] Investments and Major Shareholding Changes of Our Company—(n) December 2020 Capital Increase.”

6. Calculated based on the assumption that the [REDACTED] is HK\$[REDACTED] per Share (being the mid-point of the indicative [REDACTED] of HK\$[REDACTED] to HK\$[REDACTED]).

3. Rights of the [REDACTED] Investors

The [REDACTED] Investors were granted customary special rights, including but not limited to (i) right of first refusal and co-sale, (ii) anti-dilution rights, (iii) liquidation rights, (iv) divestment rights and (v) information rights. Pursuant to the supplemental agreements entered into by our Company with our [REDACTED] Investors dated April 16, 2021, except for the divestment rights as described below, all other special rights shall cease to be effective and be discontinued upon [REDACTED].

Divestment rights

Each [REDACTED] Investor is given the right to, upon the occurrence of specific divestment events, request Dr. Zheng, being the founding Shareholder of the Company, to purchase the Shares each [REDACTED] Investor then holds at the specified purchase price.

Pursuant to the capital increase and investment agreements (as supplemented and amended) in each round of [REDACTED] Investments and the supplemental agreements dated April 16, 2021 entered into by, among others, the Company, the [REDACTED] Investors and the then Shareholders of the Company, our [REDACTED] Investors have agreed to suspend the relevant divestment rights with effect from the date of submitting the application for the [REDACTED] of its H Shares on the Stock Exchange by the Company (the “[REDACTED]”) and terminate such divestments rights upon the [REDACTED], provided such divestment rights shall automatically be reinstated upon the earliest occurrence of any one of the following events:

- a. the Company withdraws its [REDACTED];
- b. the [REDACTED] is rejected or returned by the Stock Exchange; or
- c. the [REDACTED] lapses.

4. Joint Sponsors’ Confirmation

On the bases that (i) the consideration for the [REDACTED] Investments was irrevocably settled more than 28 clear days before the date of our first submission of the [REDACTED] to the Stock Exchange; and (ii) the special rights granted to the [REDACTED] Investors shall cease to be effective and be discontinued upon the [REDACTED] (save for the divestment rights as described above), the Joint Sponsors confirm that the [REDACTED] Investments are in compliance with the Interim Guidance on [REDACTED] Investments issued by the Stock Exchange on October 13, 2010 and as updated in March 2017 and the Guidance Letter HKEX-GL43-12 issued by the Stock Exchange in October 2012 and as updated in July 2013 and March 2017.

HISTORY, DEVELOPMENT AND CORPORATE STRUCTURE

5. Information about our [REDACTED] Investors

Our [REDACTED] Investors include Sophisticated Investor, including QM32, QM153, Shanghai Li’an, Suzhou Likang and Jiangsu Jiequan, and each Sophisticated Investor has made meaningful investment in the Company at least six months before the [REDACTED]. The background information on our [REDACTED] Investors who made meaningful investment in the Company is set out below. To the best knowledge of our Directors, save as disclosed below and in the section headed “Capitalization of Our Company” below, none of such [REDACTED] Investors have any relationship with other [REDACTED] Investors.

Qiming Venture Partners

QM32 is a company incorporated under the laws of Hong Kong, with Qiming Venture Partners V, L.P. and Qiming Managing Directors Fund V, L.P. being its shareholders. Qiming GP V, L.P. is the general partner of Qiming Venture Partners V, L.P., whereas Qiming Corporate GP V, Ltd. is the general partner of Qiming GP V, L.P. and Qiming Managing Directors Fund V, L.P. The voting and investment power of the Shares in the Company held by QM32 is exercised by Qiming Corporate GP V, Ltd., which is 25% owned by each of Mr. Duane Ziping Kuang, Mr. Gary Rieschel, Ms. Nisa Bernice Leung and Mr. Robert Headley, respectively.

QM153 is a company incorporated under the laws of Hong Kong, with Qiming Venture Partners VII, L.P. and Qiming VII Strategic Investors Fund, L.P. being its shareholders. Qiming GP VII, LLC is the general partner of both Qiming Venture Partners VII, L.P. and Qiming VII Strategic Investors Fund, L.P. The voting and investment power of the Shares in the Company held by QM153 is exercised by Qiming GP VII, LLC (together with Qiming Corporate GP V, Ltd. and their respective associates, “**Qiming Venture Partners**”), which is 25% owned by each of Mr. Duane Ziping Kuang, Mr. Gary Rieschel, Ms. Nisa Bernice Leung and Mr. Robert Headley, respectively.

Both QM32 and QM153 are set up by venture capital funds operated under Qiming Venture Partners. Qiming Venture Partners is a leading China venture capital firm with over US\$5.9 billion of assets under management, and its portfolio companies in healthcare and biotech areas include Connect Biopharma (stock sticker: CNTB (NASDAQ)), New Horizon (stock code: 6606 (SEHK)), Jacobio (stock code: 1167 (SEHK)), Antengene (stock code: 6996 (SEHK)) and SinoCellTech (stock code: 688520 (SHSE)). Each of QM32 and QM153 is focusing on the investments in healthcare and biotech and thus a Sophisticated Investor. To the best knowledge of our Directors, each of QM32 and QM153 is an Independent Third Party.

LAV

LAV is a private company limited by shares incorporated under the laws of Hong Kong and is wholly-owned by Lilly Asia Ventures Fund II, L.P., which is a Cayman exempted limited partnership fund managed by Lilly Asia Ventures Fund GP, L.P., which in turn is managed by LAV Corporate GP, Ltd. (collectively and together with their respective associates, “**LAV USD**”), which is ultimately owned by Dr. Shi Yi. To the best knowledge of our Directors, LAV is an Independent Third Party.

HISTORY, DEVELOPMENT AND CORPORATE STRUCTURE

LAV USD is a leading Asia-based life science investment firm with portfolios covering all major sectors of the biomedical and healthcare industry including biopharmaceuticals, medical devices, diagnostics and healthcare services such as CanSinBIO (康希諾生物) (stock code: 688185 (SHSE), 06185 (SEHK)), Ausun Pharm (奧翔藥業) (stock code: 603229 (SHSE)) and Kawin Technology (凱因科技) (stock code: 688687 (SHSE)). LAV USD is managed by a team of professionals with substantial biomedical domain expertise, as well as extensive investing experiences in China.

Jiangsu Jiequan

Jiangsu Jiequan (also known as “LYZZ Capital RMB Fund”) is a venture capital fund established under the laws of PRC and is managed by Jiangsu Lize Investment Management Co., Ltd. (江蘇醴澤投資管理有限公司), a company wholly-owned by Mr. Zhu Yong (朱勇). LYZZ Capital RMB Fund focuses on the investments in biotech, healthcare and other high-tech and strategic emerging industries and had RMB1.1 billion of assets under management as of March 31, 2021, thus it is a Sophisticated Investor. The invested companies of Jiangsu Jiequan in biotech and healthcare industry include Alpha Biopharma Inc (江蘇晨泰醫藥科技有限公司), Shanghai Hanyu Medical Technology Co., Ltd. (上海捍宇醫療科技股份有限公司) and Beijing Mabworks Biotech Co., Ltd. (北京天廣實生物技術股份有限公司). To the best knowledge of our Directors, LYZZ Capital RMB Fund is an Independent Third Party.

Suzhou Qiming

Suzhou Qiming is a limited partnership established under the laws of the PRC, which is controlled by Suzhou Qicheng Investment Management Partnership (Limited Partnership) (蘇州啟承投資管理合夥企業(有限合夥)), which is in turn controlled by Shanghai Qichang Investment Consulting Co., Ltd. (上海啟昌投資諮詢有限公司), a company held as to 50% and 50% by Mr. Hu Xubo, a non-executive Director of our Company, and Ms. Yu Jia (于佳), respectively. Hence, Suzhou Qiming is a connected person of our Company. Suzhou Qiming is an investment fund focusing on the investments in healthcare, TMT and cleantech areas with a fund size of RMB1 billion and its portfolio companies in healthcare and biotech area include Venus Medtech (stock code: 02500 (SEHK)), Shanghai MedSci Pharmaceutical Technology Co., Ltd. (上海梅斯醫藥科技有限公司) and Shanghai Aohua Endoscope Co., Ltd. (上海澳華內鏡股份有限公司). To the best knowledge of our Directors, Suzhou Qiming is an Independent Third Party.

Taikang Qianzhen

Taikang Qianzhen is an equity investment fund established under the laws of PRC and its general partner is Zhangjiagang Taikang Gongying Consulting Management Co., Ltd. (張家港泰康共贏諮詢管理有限公司). Taikang Qianzhen is managed by Beijing Taikang Investment Co., Ltd. (北京泰康投資管理有限公司), which mainly focuses on the investments in healthcare, technology and consumer industries. Beijing Taikang Investment Co., Ltd. is a subsidiary of Taikang Insurance Group Inc. (泰康保險集團股份有限公司). Founded in 1996, Taikang Insurance Group is an insurance and financial service conglomerate focused on insurance, asset management and health and elderly care as main businesses. To the best knowledge of our Directors, Taikang Qianzhen is an Independent Third Party.

HISTORY, DEVELOPMENT AND CORPORATE STRUCTURE

Shanghai Li’an and Suzhou Likang

Shanghai Li’an and Suzhou Likang are venture capital funds established under the laws of PRC and are both managed by Shanghai Liyi Investment Management Partnership (Limited Partnership) (上海禮頤投資管理合夥企業(有限合夥)) which is in turn managed by Shanghai Liyao Investment Management Co., Ltd. Each of Shanghai Li’an with over RMB226 million of assets under management and Suzhou Likang with over RMB2.5 billion focuses on the investments in healthcare area and thus a Sophisticated Investor. The portfolio companies of Shanghai Li’an and Suzhou Likang in healthcare area include CanSinBIO (康希諾生物) (stock code: 688185 (SHSE), 06185 (SEHK)), Ausun Pharm (奧翔藥業) (stock code: 603229 (SHSE)), Allist Pharmaceuticals (艾力斯醫藥) (stock code: 688578 (SHSE)) and Remegen (榮昌生物) (stock code: 9995 (SEHK)). To the best knowledge of our Directors, Shanghai Li’an and Suzhou Likang are Independent Third Parties.

Shanghai Zouzhen

Shanghai Zouzhen is a limited partnership established under the laws of PRC. Its general partner is Shanghai Growth-FOF Equity Investment Management Co., Ltd. (上海國方母基金股權投資管理有限公司, “**GF Capital**”, together with its associates, “**GF Capital Investment**”) whose single largest shareholder (owned as to 35%) is SIG Asset Management Co., Ltd. (上海國際集團資產管理有限公司, “**SIG AM**”). SIG AM is a state-owned enterprise and is ultimate controlled by Shanghai State-owned Assets Supervision and Administration Committee (上海市國有資產監督管理委員會). Shanghai Zouzhen focuses on the investments in advanced manufacturing, healthcare and information services industries. Shanghai Zouzhen has over RMB1.3 billion of registered capital. The portfolio companies of GF Capital Investment in biotech and healthcare industry include MGI Tech Co., Ltd. (深圳華大智造科技股份有限公司), Shanghai Zhenge Biotech Co., Ltd. (上海臻格生物技術有限公司), Wuhan Neurophth Biological Technology Limited Company (武漢紐福斯生物科技股份有限公司), Beijing Kunlun Medical Technology Co., Ltd. (科亞醫療科技股份有限公司 (formerly known as 北京科亞方舟醫療科技股份有限公司)), MicroPort (Shanghai) MedBot Co., Ltd. (上海微創醫療機器人(集團)股份有限公司). To the best knowledge of our Directors, Shanghai Zouzhen is an Independent Third Party.

Hangzhou Jiuyao and Hangzhou Jiufu

Each of Hangzhou Jiuyao and Hangzhou Jiufu is an equity investment fund established under the laws of PRC and is managed by Zhejiang Jiuren Capital Management Co., Ltd. (浙江九仁資本管理有限公司). Hangzhou Jiuyao has an investment size of RMB53 million and Hangzhou Jiufu has an investment size of RMB30 million. The invested companies of Hangzhou Jiuyao in biotech and healthcare industry also include Beijing Genomeprecision Medical Technology Co., Ltd. (北京旌准醫療科技有限公司). To the best knowledge of our Directors, each of Hangzhou Jiuyao and Hangzhou Jiufu is an Independent Third Party.

HISTORY, DEVELOPMENT AND CORPORATE STRUCTURE

Shenzhen Tencent

Shenzhen Tencent is a limited liability company incorporated under the laws of PRC and wholly-owned by Tencent Technology (Shenzhen) Co., Ltd. (騰訊科技(深圳)有限公司), which is wholly-owned by Oriental Power Holdings Limited, which in turn is wholly-owned by Tencent Holding Limited (together with its subsidiaries, “**Tencent Group**”), whose shares are listed on the Stock Exchange (stock code: 0700). Tencent Group is a leading provider of internet value added services in China. To the best knowledge of our Directors, Shenzhen Tencent is an Independent Third Party.

Zhuhai Yitai

Zhuhai Yitai, with registered capital of RMB101 million, is a limited partnership established under the laws of PRC and its general partner is Shenzhen Jingchuang Zhizao Enterprise Management Partnership (Limited Partnership) (深圳精創智造企業管理合夥企業(有限合夥)) (“**Shenzhen Jingchuang**”), which is ultimately controlled by Mr. Li Jianguang (李建光), Mr. Niu Kuiguang (牛奎光) and Mr. Wang Jingbo (王靜波). To the best knowledge of our Directors, Zhuhai Yitai is an Independent Third Party.

CD Capital

Power SUM is a limited company incorporated under the laws of Hong Kong, which is wholly-owned by Master Summer Limited, a company controlled by CDBI Partners Fund I, L.P. and ultimately controlled by Mr. Tan Ching (談慶). Hangzhou Chende is a limited partnership established under the laws of PRC and its sole general partner is Shanghai Jiachen Investment Co., Ltd. (上海甲辰投資有限公司), which is wholly-owned by Mr. Tan Yuren (談玉仁). Both Power SUM and Hangzhou Chende are investment vehicles of CD Capital (“**CD Capital**”), a venture capital firm specialized in life science and medical technology industries with over USD750 million of assets under management. The portfolio companies of CD Capital in biotech and healthcare industry include Guangzhou Kingmed Diagnostics Group Co Ltd (廣州金域醫學檢驗集團股份有限公司) (stock code: 603882 (Shanghai Stock Exchange)) and Shanghai iRay Electronic Technology Co., Ltd. (上海奕瑞光電子科技股份有限公司) (stock code: 688301 (Shanghai Stock Exchange)). To the best knowledge of our Directors, each of Power SUM and Hangzhou Chende is an Independent Third Party.

Hangzhou Zibo

Hangzhou Zibo is a limited partnership established under the laws of PRC and its sole general partner is Hangzhou Zijingang Investment Management Co., Ltd. (杭州紫金港投資管理有限公司), which is ultimately controlled by Chen Jun (陳軍). Hangzhou Zibo focuses on the investment in healthcare industry. The invested companies of Hangzhou Zibo in biotech and healthcare industry also include Hangzhou Diagen Biotech Co., Ltd. (杭州德適生物科技有限公司). To the best knowledge of our Directors, Hangzhou Zibo is an Independent Third Party.

HISTORY, DEVELOPMENT AND CORPORATE STRUCTURE

PUBLIC FLOAT

The 286,473,574 Shares held by Dr. Zheng, Jiangsu Jiequan, Hangzhou Yantai, Suzhou Qiming, Hangzhou Hengtai, Taikang Qianzhen, Shanghai Li'an, Shanghai Zouzhen, Hangzhou Jiuyao, Hangzhou Jiufu, Suzhou Likang, Shenzhen Tencent, Zhuhai Yitai, Dore Chin Mark, Hangzhou Zibo, Hangzhou Chende, Mr. Zhu Liuping, Hangzhou Yunbo, Hangzhou Jiuge, Jiaxing Furui, Suzhou Chenzhide, Nanjing Sanzheng, CICC Pucheng, Mr. Teng Rongsong and Shanghai Guangkong, representing approximately 79.58% of our total issued Shares as of the Latest Practicable Date, or approximately [REDACTED]% of our total issued Shares upon [REDACTED] (assuming the [REDACTED] is not exercised), or approximately [REDACTED]% of our total issued Shares upon exercise of the [REDACTED] in full, will not be considered as part of the public float as the Shares they hold are Domestic Shares which will not be converted into H Shares and [REDACTED] upon the completion of the [REDACTED].

The 73,526,426 Unlisted Foreign Shares held by LAV, QM32, QM153 and Power SUM, representing approximately 20.42% of our total issued Shares as of the Latest Practicable Date, or approximately [REDACTED]% of our total issued Shares upon [REDACTED] (assuming the [REDACTED] is not exercised), or approximately [REDACTED]% of our total issued Shares upon exercise of the [REDACTED] in full, will not be considered as part of the public float as the Shares they hold are Unlisted Foreign Shares which will not be converted into H Shares and [REDACTED] upon the completion of the [REDACTED].

Pursuant to the applicable PRC law, within the 12 months following the [REDACTED], all current Shareholders could not dispose of any of the Shares held by them.

Based on the above, it is expected that immediately following completion of the [REDACTED] and assuming the [REDACTED] is not exercised, the total number of [REDACTED] H Shares of our Company held by the public represents [REDACTED]% of the total number of issued Shares of our Company. [REDACTED]

Immediately upon completion of the [REDACTED], assuming that (i) [REDACTED] H Shares are issued in the [REDACTED] and (ii) the [REDACTED] is not exercised, based on an [REDACTED] of HK\$[REDACTED] per H Share (being the mid-point of the indicative [REDACTED]), the Company will have a market capitalization of at least HK\$[REDACTED] held by the public as required under Rule 18A.07 of the Listing Rules.

THE A SHARE [REDACTED]

We may conduct the [REDACTED] and [REDACTED] of A shares at an appropriate time after the [REDACTED]. As of the Latest Practicable Date, we have not determined the size and scope of the contemplated A share [REDACTED] and have not made any application to any recognized stock exchange in the PRC for approval for the [REDACTED] of any A shares. There is no assurance we will conduct an A share [REDACTED] in the future.

HISTORY, DEVELOPMENT AND CORPORATE STRUCTURE

CAPITALIZATION OF OUR COMPANY

The table below is a summary of the capitalization of our Company as of the date of this Document and the [REDACTED] (assuming the [REDACTED] is not exercised):

Shareholders	Number of Shares	Ownership percentage as of the date of this Document	Ownership percentage as of the [REDACTED]
Dr. Zheng ^{(A)(1)}	88,278,594	24.52%	[REDACTED]
QM32 ^{(B)(2)}	34,071,947	9.46%	[REDACTED]
LAV ^(B)	25,637,520	7.12%	[REDACTED]
Jiangsu Jiequan ^(A)	23,517,076	6.53%	[REDACTED]
Hangzhou Yantai ^{(A)(1)}	19,031,297	5.29%	[REDACTED]
Suzhou Qiming ^{(A)(3)}	16,055,165	4.46%	[REDACTED]
Hangzhou Hengtai ^{(A)(1)}	15,698,265	4.36%	[REDACTED]
Taikang Qianzhen ^(A)	13,455,691	3.74%	[REDACTED]
Shanghai Li'an ^{(A)(4)}	11,983,877	3.33%	[REDACTED]
Shanghai Zouzhen ^(A)	11,503,955	3.20%	[REDACTED]
Hangzhou Jiuyao ^{(A)(5)}	10,683,565	2.97%	[REDACTED]
Hangzhou Jiufu ^{(A)(5)}	10,683,565	2.97%	[REDACTED]
Suzhou Likang ^{(A)(4)}	9,792,927	2.72%	[REDACTED]
Shenzhen Tencent ^(A)	8,970,446	2.49%	[REDACTED]
Zhuhai Yitai ^(A)	7,176,383	1.99%	[REDACTED]
Power SUM ^{(B)(6)}	6,958,131	1.93%	[REDACTED]
Dore Chin Mark ^(A)	6,938,133	1.93%	[REDACTED]
QM153 ^{(B)(2)}	6,858,828	1.91%	[REDACTED]
Hangzhou Zibo ^(A)	5,697,901	1.58%	[REDACTED]
Hangzhou Chende ^{(A)(6)}	5,341,781	1.48%	[REDACTED]
Mr. Zhu Liuping ^(A)	4,206,721	1.17%	[REDACTED]
Hangzhou Yunbo ^{(A)(5)}	3,804,018	1.06%	[REDACTED]
Hangzhou Jiuge ^{(A)(5)}	2,855,898	0.79%	[REDACTED]
Jiaxing Furui ^(A)	1,827,776	0.51%	[REDACTED]
Suzhou Chenzhide ^{(A)(6)}	1,794,108	0.50%	[REDACTED]
Nanjing Sanzheng ^(A)	1,794,108	0.50%	[REDACTED]
CICC Pucheng ^(A)	1,794,108	0.50%	[REDACTED]
Mr. Teng Rongsong ^(A)	1,794,108	0.50%	[REDACTED]
Shanghai Guangkong ^(A)	1,794,108	0.50%	[REDACTED]
Investors taking part in the [REDACTED]	[REDACTED]	[REDACTED]	[REDACTED]
Total	[REDACTED]	100.00%	[REDACTED]

HISTORY, DEVELOPMENT AND CORPORATE STRUCTURE

Notes:

- (1) Dr. Zheng, being the sole general partner, controls and manages Hangzhou Yantai and Hangzhou Hengtai, both of which are Employee Incentive Platforms. Dr. Zheng, Hangzhou Yantai and Hangzhou Hengtai are collectively interested in approximately 34.17% interest of our total issued share capital immediately prior to the [REDACTED]. Each of Dr. Zheng, Hangzhou Yantai and Hangzhou Hengtai is a member of the Single Largest Group of Shareholders of our Company upon [REDACTED].
- (2) QM32 is controlled by Qiming Venture Partners V, L.P. which is ultimately controlled by Qiming Corporate GP V, Ltd., a company 25% owned by each of Mr. Duane Ziping Kuang, Mr. Gary Rieschel, Ms. Nisa Bernice Leung and Mr. Robert Headley, respectively. QM153 is controlled by Qiming Venture Partners VII, L.P., which is ultimately controlled by Qiming GP VII, LLC, a company also 25% owned by each of Mr. Duane Ziping Kuang, Mr. Gary Rieschel, Ms. Nisa Bernice Leung and Mr. Robert Headley, respectively. QM32 and QM153 are collectively interested in 11.36% interest of our total issued share capital immediately prior to the [REDACTED].
- (3) Suzhou Qiming is managed by Suzhou Qicheng Investment Management Partnership (Limited Partnership) (蘇州啟承投資管理合夥企業(有限合夥)), which is in turn managed by Shanghai Qichang Investment Consulting Co., Ltd. (上海啟昌投資諮詢有限公司), a company held as to 50% by Mr. Hu Xubo, a non-executive Director of our Company. Thus Suzhou Qiming is a connected person of the Company.
- (4) Shanghai Li'an and Suzhou Likang are both managed by Shanghai Liyi Investment Management Partnership (Limited Partnership) (上海禮頤投資管理合夥企業(有限合夥)), which in turn is managed by Shanghai Liyao Investment Management Co., Ltd. Shanghai Li'an and Suzhou Likang are collectively interested in approximately 6.05% interest of our total issued share capital immediately prior to the [REDACTED].
- (5) Zhejiang Jiuren Capital Management Co., Ltd. (浙江九仁資本管理有限公司) manages Hangzhou Jiuyao, Hangzhou Jiufu, Hangzhou Yunbo and Hangzhou Jiuge in its capacity as the fund manager of these funds. Hangzhou Jiuyao, Hangzhou Jiufu, Hangzhou Yunbo and Hangzhou Jiuge, collectively interested in approximately 7.79% interest of our total issued share capital immediately prior to the [REDACTED].
- (6) Power SUM is wholly-owned by Master Summer Limited, a company controlled by CDBI Partners Fund I, L.P. and ultimately controlled by Mr. Tan Ching (談慶). Each of Hangzhou Chende and Suzhou Chenzhide is managed by its sole general partner Shanghai Jiachen Investment Co., Ltd. (上海甲辰投資有限公司), which is wholly-owned by Mr. Tan Yuren (談玉仁) and its legal representative is Mr. Tan Ching. Power SUM, Hangzhou Chende and Suzhou Chenzhide are collectively interested in approximately 3.91% interest of our total issued share capital immediately prior to the [REDACTED].

Remarks

- (A) The Shares held by these Shareholders are Domestic Shares.
- (B) The Shares held by these Shareholders are Unlisted Foreign Shares.

HISTORY, DEVELOPMENT AND CORPORATE STRUCTURE

CORPORATE STRUCTURE IMMEDIATELY BEFORE COMPLETION OF THE [REDACTED]

The chart below sets out the shareholding structure of our Company immediately before completion of the [REDACTED]:

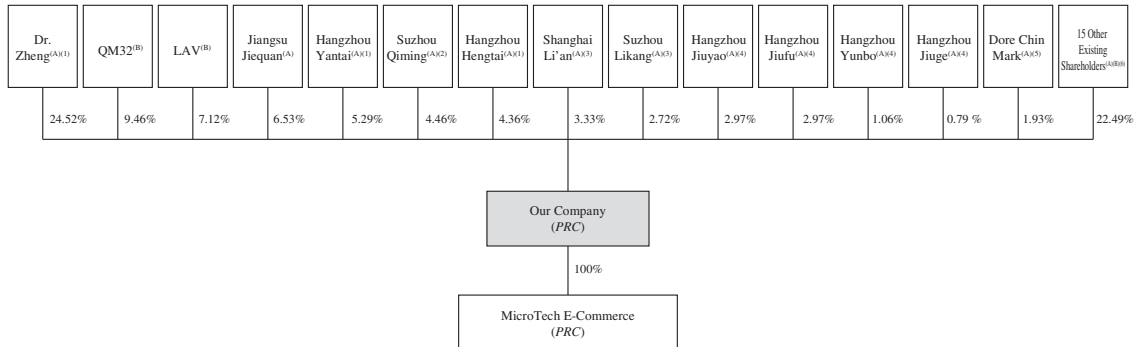

Notes:

- (1) Dr. Zheng, being the sole general partner, controls and manages Hangzhou Yantai and Hangzhou Hengtai, both of which are Employee Incentive Platforms. Dr. Zheng, Hangzhou Yantai and Hangzhou Hengtai are collectively interested in approximately 34.17% interest of our total issued share capital immediately prior to the [REDACTED]. Each of Dr. Zheng, Hangzhou Yantai and Hangzhou Hengtai is a member of the Single Largest Group of Shareholders of our Company upon [REDACTED].
- (2) Suzhou Qiming is managed by Suzhou Qicheng Investment Management Partnership (Limited Partnership) (蘇州啟承投資管理合夥企業(有限合夥)), which is in turn managed by Shanghai Qichang Investment Consulting Co., Ltd. (上海啟昌投資諮詢有限公司), a company held as to 50% by Mr. Hu Xubo, a non-executive Director of our Company.
- (3) Shanghai Li'an and Suzhou Likang are both managed by Shanghai Liyi Investment Management Partnership (Limited Partnership) (上海禮頤投資管理合夥企業(有限合夥)), which in turn is managed by Shanghai Liyao Investment Management Co., Ltd. Shanghai Li'an and Suzhou Likang is collectively interested in approximately 6.05% interest of our total issued share capital immediately prior to the [REDACTED].
- (4) Zhejiang Jiuren Capital Management Co., Ltd. (浙江九仁資本管理有限公司) manages Hangzhou Jiuyao, Hangzhou Jiufu, Hangzhou Yunbo and Hangzhou Jiuge in its capacity as the fund manager of these funds. Hangzhou Jiuyao, Hangzhou Jiufu, Hangzhou Yunbo and Hangzhou Jiuge, collectively interested in approximately 7.79% interest of our total issued share capital immediately prior to the [REDACTED].
- (5) Mr. Dore Chin Mark is the vice president of our Company. See “Directors, Supervisors and Senior Management” for the detailed background information of Mr. Dore Chin Mark.
- (6) For details on the 15 other existing Shareholders, see the capitalization table of our Company in “—Capitalization of our Company.”
- (7) See “Detailed Terms of the [REDACTED] Investments—5. Information about our [REDACTED] Investors” for the beneficial owners of our [REDACTED] Investors and their relationship with our Company.

Remarks

- (A) The Shares held by these Shareholders are Domestic Shares.
- (B) The Shares held by these Shareholders are Unlisted Foreign Shares.

HISTORY, DEVELOPMENT AND CORPORATE STRUCTURE

CORPORATE STRUCTURE IMMEDIATELY FOLLOWING COMPLETION OF THE [REDACTED]

The chart below sets out the shareholding structure of our Company immediately following completion of the [REDACTED] (assuming the [REDACTED] is not exercised):

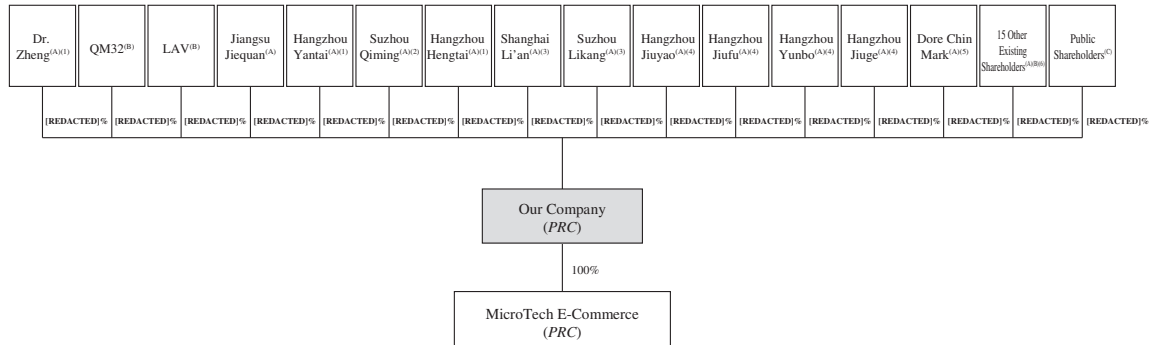

Notes:

- (1) Dr. Zheng, being the sole general partner, controls and manages Hangzhou Yantai and Hangzhou Hengtai, both of which are Employee Incentive Platforms. Dr. Zheng, Hangzhou Yantai and Hangzhou Hengtai are collectively interested in approximately [REDACTED]% interest of our total issued share capital immediately following completion of the [REDACTED] (assuming the [REDACTED] is not exercised). Each of Dr. Zheng, Hangzhou Yantai and Hangzhou Hengtai is a member of the Single Largest Group of Shareholders of our Company upon [REDACTED].
- (2) Suzhou Qiming is managed by Suzhou Qicheng Investment Management Partnership (Limited Partnership) (蘇州啟承投資管理合夥企業(有限合夥)), which is in turn managed by Shanghai Qichang Investment Consulting Co., Ltd. (上海啟昌投資諮詢有限公司), a company held as to 50% by Mr. Hu Xubo, a non-executive Director of our Company.
- (3) Shanghai Li'an and Suzhou Likang are both managed by Shanghai Liyi Investment Management Partnership (Limited Partnership) (上海禮頤投資管理合夥企業(有限合夥)), which in turn is managed by Shanghai Liyao Investment Management Co., Ltd. Shanghai Li'an and Suzhou Likang is collectively interested in approximately [REDACTED]% interest of our total issued share capital immediately following completion of the [REDACTED] (assuming the [REDACTED] is not exercised).
- (4) Zhejiang Jiuren Capital Management Co., Ltd. (浙江九仁資本管理有限公司) manages Hangzhou Jiuyao, Hangzhou Jiufu, Hangzhou Yunbo and Hangzhou Jiuge in its capacity as the fund manager of these funds. Hangzhou Jiuyao, Hangzhou Jiufu, Hangzhou Yunbo and Hangzhou Jiuge, collectively interested in approximately [REDACTED]% interest of our total issued share capital immediately following completion of the [REDACTED] (assuming the [REDACTED] is not exercised).
- (5) Mr. Dore Chin Mark is the vice president of our Company. See “Directors, Supervisors and Senior Management” for the detailed background information of Mr. Dore Chin Mark.
- (6) For details on the 15 other existing Shareholders, see the capitalization table of our Company in “—Capitalization of our Company.”
- (7) See “Detailed Terms of the [REDACTED] Investments—5. Information about our [REDACTED] Investors” for the beneficial owners of our [REDACTED] Investors and their relationship with our Company.

Remarks

- (A) The Shares held by these Shareholders are Domestic Shares.
- (B) The Shares held by these Shareholders are Unlisted Foreign Shares.
- (C) The Shares held by these Shareholders are H Shares.

BUSINESS

OVERVIEW

We are a pioneer in the diabetes management medical devices industry that innovates and integrates the treatment and monitoring of diabetes to reshape the diabetes management paradigm in China and globally. We are the only company that has commercialized both patch insulin delivery system and calibration-free CGMS in the world, according to the CIC Report. We believe that our comprehensive and market-leading product portfolio, our advanced positioning in the development of closed loop solutions, our deeply integrated treatment and monitoring platform created through robust R&D, manufacturing and commercialization capabilities, together with our visionary management team, significantly differentiate us from our peers. We are dedicated to helping people with diabetes lead healthier lives. Our long-term mission is to become the global leader in diabetes management.

We operate in a large and fast-growing diabetes monitoring, treatment and management market in China and globally with significant unmet clinical needs. Diabetes is one of the most prevalent chronic diseases, which is often frustrating and difficult for patients to manage. According to the CIC Report, the global prevalence of diabetes was 486.9 million people in 2019 and is expected to reach 607.6 million people in 2030. According to the same source, the prevalence of diabetes in China was 118.8 million people in 2019 and is expected to reach 143.2 million people in 2030. The global market size of diabetes management medical devices is expected to increase from US\$47.8 billion in 2020 to US\$111.1 billion in 2030, representing a CAGR of 8.8%, with the Chinese market alone to increase from US\$2.4 billion in 2020 to US\$9.5 billion in 2030, representing a CAGR of 14.7%. Meanwhile, there are significant unmet clinical needs for medical devices that can operate on a real-time and continuous basis to lower the risks of hypo/hyper-glycaemia and offer significant short-term and long-term benefits to patients. Manufacturers are required to have multi- and cross- disciplinary capabilities for the R&D of such innovative medical devices. To capitalize this market opportunity, we were founded in 2011 with the objective to reshape the diabetes monitoring, treatment and management paradigm through closed loop solutions that dynamically monitor and control the blood glucose level. Over the last ten years, we have strategically developed a robust and comprehensive product portfolio across multiple product lines, including patch insulin pump system and CGMS, which form the basis of the closed loop artificial pancreas, as well as IVD devices, such as BGMS and POCT devices.

Equil, our Core Product, is the second commercialized semi-disposable patch insulin pump globally, and the first and only domestically developed patch insulin pump approved in both China and the EU. Compared to traditional tubed pumps, Equil features a tubeless and lightweight design, enabling users to manage diabetes discreetly and safely. Other innovative attributes include a vibration alert that users can feel underneath their clothing and a dedicated bolus button that can initiate insulin delivery without the remote control. Furthermore, Equil has comparable or better performance than major peer products, with improved safety, better accuracy and semi-disposability. In September 2017, Equil received the marketing approval for adult use from the NMPA in China. Equil also received CE marking in the EU in the same year. As of the Latest Practicable Date, we had successfully marketed Equil in over 15 countries

BUSINESS

across Asia Pacific, Europe, Middle East, Africa and Latin America. In February 2021, we submitted a 510(k) premarket notification to the FDA and we expect to receive FDA clearance for Equil in the first half of 2022.

AiDEX G7, our CGMS, is the second commercialized calibration-free real-time CGMS in the world. Since its launch, AiDEX G7 has demonstrated various advantages over traditional BGMS products, featuring real-time monitoring, reduced risk of hyper/hypoglycemia, and increased compliance to treatment regimen without taking routine finger prick blood glucose measurements. AiDEX G7 also performs better than, or on par with, global peer products in terms of accuracy, calibration, usage time and transmitter life. AiDEX G7 received CE marking in the EU in September 2020. We completed a clinical trial for AiDEX G7 in China in May 2020 and the NMPA accepted our registration application in the first quarter of 2021. AiDEX G7 has been certified by the NMPA in May 2020 to be eligible for the Special Approval Procedures of Innovative Medical Devices promulgated by the NMPA. When approved, AiDEX G7 is expected to be the first calibration-free real-time CGMS approved for commercialization in China.

Besides Equil and AiDEX G7, we have developed a robust pipeline of product candidates with improved features, including our closed loop artificial pancreas, second-generation patch insulin pump system, AiDEX X and IVD devices. The following chart summarizes the development status of our products and major product candidates:

Product Line	Product	Major Markets	Preclinical	Clinical	Registration	Commercialization	Expected Completion of Current Stage	Expected Commercial Launch
Patch Insulin Pump System	Equil * (for adult use)		[Progress bar: Preclinical to Commercialization]				N/A	Launched
			[Progress bar: Preclinical to Commercialization]				N/A	Launched
	Equil * (for child and adolescent use) Second-Generation Patch Insulin Pump System*		[Progress bar: Preclinical to Registration]				1H 2022	1H 2022
			[Progress bar: Preclinical to Clinical]				2H 2021****	1H 2022****
Continuous Glucose Monitoring System	AiDEX G7 (for adult use)		[Progress bar: Preclinical to Registration] ▲				2H 2021	2H 2021
			[Progress bar: Preclinical to Commercialization]				N/A	Launched
	AiDEX G7 (for child and adolescent use) AiDEX X		[Progress bar: Preclinical to Clinical]				1H 2022	1H 2023
			[Progress bar: Preclinical to Clinical]				2H 2021****	1H 2022****
Closed Loop Artificial Pancreas	PanCares Artificial Pancreas* Cloud-based AI-powered Artificial Pancreas		[Progress bar: Preclinical to Clinical]				2H 2021****	1H 2023****
			[Progress bar: Preclinical to Clinical]				1H 2022****	2H 2023****
IVD	BGMS Products**		[Progress bar: Preclinical to Commercialization]				N/A	Launched
	Exactive Pro Glucose, Ketone, Uric Acid Monitoring System		[Progress bar: Preclinical to Clinical]				2H 2021	1H 2022
	IVocare Multifunctional POCT		[Progress bar: Preclinical to Registration]				2H 2021	2H 2021

* Core Product: further R&D includes indication expansion to children and adolescents, and product improvement including the development of second-generation patch insulin pump system and artificial pancreas.
▲ Eligible for NMPA Special Approval Procedures of Innovative Medical Devices
* Development of second-generation patch insulin pump system and artificial pancreas is part of the further R&D plans of our Core Product, which are expected to improve the features of our Core Product.
** Including multiple types of blood glucose meters and test strips approved for commercialization in China, the EU and/or the US
*** For commercialization in China and the EU
**** For commercialization in China

BUSINESS

As we build up our product pipeline, we have developed a deeply integrated treatment and monitoring platform with robust R&D, manufacturing and commercialization capabilities.

- *R&D.* We had a proven record of R&D experience. We were designated as the Key Diabetes Research Center in Zhejiang Province, China, and we had also established a R&D center in Silicon Valley. Equil, our Core Product, was designated as an Innovative Medical Device Product by the PRC Ministry of Science and Technology. Led by Dr. Zheng Pan, our Chief Executive Officer, who has nearly 20 years of experience in the healthcare industry, we have formed a robust R&D team with extensive industry experience and multidisciplinary capabilities. We remain at the forefront of innovation by maintaining close contact with leading medical professionals and KOLs and develop products that specifically address the unmet clinical needs. Our superior R&D capabilities will allow us to pioneer the development of high-quality closed loop solutions, patch insulin pump systems and CGMS products in a cost-effective manner.
- *Manufacturing.* We conduct all the key manufacturing procedures in-house. Over the years, we have accumulated extensive expertise and know-how in manufacturing diabetes management medical devices, which sets a solid foundation for our long-term growth. We own manufacturing facilities with an aggregate area of approximately 15,000 sq.m. in Hangzhou, China, including a 1,500 sq.m. ISO Class 7 clean-room space and an 80 sq.m. ISO Class 8 clean-room space. We uphold manufacturing quality management, and have received major international certifications. Our emphasis on the automatic and continuous control of manufacturing processes also significantly contributes to the improvement of our overall production quality and efficiency.
- *Commercialization.* We strategically use a combination of our in-house sales and marketing team and a broad network of independent distributors to sell our products in China and overseas. We had 370 distributors as of December 31, 2020 and over 120 in-house sales and marketing personnel as of the Latest Practicable Date, covering the sales of our products across 30 provinces, municipalities and autonomous regions in China, and over 60 countries overseas. We have developed a global footprint in Asia Pacific, Europe, Middle East, Africa and Latin America.

Our large portfolio of marketed products and deeply integrated treatment and monitoring platform have enabled us to achieve rapid growth. Furthermore, we are currently in the early stage of marketing our patch insulin pump system and CGMS. We expect our business will continue to grow, as we ramp up the sales of our patch insulin pump system and CGMS, and commence the marketing of our closed loop solutions, in particular, our artificial pancreas.

BUSINESS

As our product portfolio diversifies, we are making efforts in the design and training of control algorithms for our closed loop solutions. We are also seeking to synthesize advanced analytical tools and AI to gain in-depth insights into diabetes management.

We aspire to significantly improve treatment outcomes and ultimately reshape the diabetes monitoring, treatment and management paradigm in China and globally. To achieve such aspiration, we will keep improving the features and quality of our products, developing our R&D capabilities, expanding our global footprint and building a cloud-based diabetes management platform to bring clinical and commercial benefits to diabetes patients all over the world.

OUR COMPETITIVE STRENGTHS

We believe the following strengths have contributed to our success and differentiated us from our competitors.

Pioneer of reshaping diabetes management paradigm through integrated continuous treatment and monitoring devices in China and globally

We are pioneering the reshaping of diabetes management paradigm in China and globally, through the development of closed loop solutions, such as the artificial pancreas, that integrate the continuous treatment and monitoring of diabetes to meet the significant unmet clinical needs. Such closed loop solutions will require two essential components: a continuous insulin delivery system that provides background and on demand insulin dosages that compensate for blood glucose fluctuations and a CGMS that provides real-time monitoring of glucose levels. As of the Latest Practicable Date, we are the only company that has commercialized both patch insulin delivery system and calibration-free CGMS in the world, according to the CIC report:

- *Equil*, our patch insulin delivery system, is the second commercialized semi-disposable patch insulin pump globally and the first and the only domestically developed patch insulin pump system approved in both China and the EU;
- *AiDEX G7*, our CGMS, is the second commercialized calibration-free real-time CGMS in the world.

We believe that these two commercial-stage products have paved the way for us to internally develop the closed loop artificial pancreas without the need to seek collaborations for complementary technologies. More importantly, the united features of our patch insulin pump system and CGMS will benefit us in the research, development and commercialization of closed loop solutions in the following aspects:

- *Deep integration*: Enable us to create a cohesive and user-friendly ecosystem of products with deep integration, as opposed to those with fragmented technologies attempting to work at many levels;

BUSINESS

- *Unified design*: Enable us to leverage the user feedback collected from the users of one product in the design, development and optimization of the other;
- *Unified implementation*: Enable us to share common components between our CGMS and patch insulin pump system, which will reduce the complexity and cost for replacements and optimize the user experience;
- *Unified manufacturing and quality systems*: Enable us to improve operational and cost efficiency through unified manufacturing and quality control systems;
- *Unified data platform*: Enable users and healthcare institutions to receive and share data in a unified data platform provided by us, rather than from separate glucose monitoring and insulin delivery device companies; and
- *Unified sales and service*: Enable us to offer one-stop sales and services of both continuous glucose monitoring and insulin delivery systems to users.

In addition, we are seeking to harness big data analytics and AI technologies to further improve the software and the hardware of our existing products and our closed loop solutions under development.

With our strong product portfolio, years of experience and technological advances, we believe that we are well-positioned to bring to market real-time, highly accurate, user-friendly and affordable closed loop solutions, including the artificial pancreas, which could rapidly penetrate the diabetes market and reshape the current diabetes management paradigm.

Leading patch insulin pump portfolio with the first and only domestically developed patch insulin pump

Equil is the second commercialized semi-disposable patch insulin pump globally and the first and the only domestically developed patch insulin pump approved in both China and the EU.

Insulin pumps are continuous subcutaneous insulin infusion (“CSII”) therapy devices used for administering insulin infusion in diabetes treatment. CSII therapy has been shown to provide better glycemic control and increased lifestyle flexibility for patients requiring insulin-dependent therapies. In China, CSII therapy has been included in the clinical guidelines for treatment of Type 1 and Type 2 diabetes. CSII therapy has also been recognized and recommended for use in short-term insulin intensive therapy. Coupled with wider adoption of CSII therapy, there has been a growing market demand for insulin pumps. According to the CIC Report, the global market size of the insulin pump market increased from US\$4.1 billion in 2015 to US\$5.6 billion in 2020 at a CAGR of 6.6% and is expected to reach US\$20.7 billion in 2030 at a CAGR of 14.0% from 2020 to 2030; and the market size of the insulin pump market in China increased from US\$58.1 million in 2015 to US\$125.4 million in 2020 at a CAGR of 16.6% and is expected to reach US\$1.0 billion in 2030 at a CAGR of 23.3% from 2020 to 2030.

BUSINESS

Currently, tubed insulin pumps and tubeless patch insulin pumps are the two main types of insulin pumps. Patch insulin pumps are found to be significantly better than traditional tubed insulin pumps, as they avoid tubing issues and increase patients’ adherence treatment regimens by featuring tubeless, smaller device size, and greater portability. Equil is the second commercialized semi-disposable patch insulin pump globally. In addition, of all the insulin pump products currently approved in China, Equil is the only domestically developed patch insulin pump. We believe that Equil is a top-notch patch insulin pump system with better or comparable features than the commercialized peer products, as illustrated in the chart below:

Company Product name	The Company Equil	Insulet Omnipod-Dash System
Pump	Semi-disposable	Disposable, one-time use
Bolus button	Yes	No
Alarms	Patch pump: LED and vibration Remote: LED, sound, and vibration	Pod: LED and sound Remote: LED and sound
Convenience	The pump body can be removed from the body as needed, and can be reattached	Pod cannot be reused if removed from the body
Regulatory	Compliant with applicable NMPA regulations	Adjustments may be required to comply with applicable NMPA regulations
Delivery specs	Minimum step size: 0.025U	Minimum step size: 0.050U

Source: CIC Report

As of the Latest Practicable Date, we had successfully marketed Equil in over 15 countries across Asia Pacific, Europe, Middle East, Africa and Latin America. As part of the further R&D of Equil, we are also developing our second-generation patch insulin pump system, featuring smaller size, improved waterproof performance, better adaptability to insulin reservoirs in different sizes, and augmented user-friendliness. The insulin pump, as a continuous insulin delivery device, is also an essential component of closed loop artificial pancreas. We expect to equip our second-generation patch insulin pump system with internal control algorithms, which, together with our CGMS, is expected to form the bedrock of our closed loop artificial pancreas.

Global leading player in the field of CGMS with top-notch product portfolio

Our first CGMS, AiDEX G7, is the second commercialized calibration-free real-time CGMS in the world.





In recent years, CGMS has been quickly penetrating the diabetes monitoring medical devices market and gradually replacing the conventional BGMS. According to the CIC Report, the global market size of CGMS was US\$5.7 billion in 2020 and is expected to reach US\$36.5 billion in 2030. CGMS offers multiple prominent clinical benefits and advantages over conventional BGMS. BGMS usually involves unpleasant blood draws using finger pricks. Users also need to reload a disposable strip into the blood glucose meter every time reading is taken. By contrast, a growing number of CGMS products are calibration-free (i.e., no

BUSINESS

finger-prick calibration), which measure and record glucose levels in real time every one to five minutes without the pain of finger-pricking. CGMS promotes better adherence to treatment regimens in diabetes patients by simplifying and making the process of glucose monitoring and management pain free.

AiDEX G7 enjoys favorable commercialization positioning in China and globally. We completed a clinical trial for AiDEX G7 in China in May 2020 and the NMPA accepted our registration application in the first quarter of 2021. AiDEX G7 has been certified by the NMPA in May 2020 to be eligible for the Special Approval Procedures of Innovative Medical Devices promulgated by the NMPA. When approved, AiDEX G7 is expected to be the first calibration-free CGMS approved for commercialization in China that addresses the significant unmet clinical needs. AiDEX G7 received CE marking in September 2020, and we started to commercialize AiDEX G7 in Europe in March 2021.

We believe AiDEX G7 is a superior CGMS with better or comparable features than the leading peer products in the world, as demonstrated in the chart below:

Performance	The Company’s AiDEX G7	Abbott Libre	Medtronic Guardian	Dexcom G6
Calibration	Calibration-free	Calibration-free	Twice per day	Calibration-free
Usage Time	14 days	14 days	7 days	10 days
Startup Time	1 hour	1 hour	2 hours	2 hours
Transmitter Life	4 years	1 year (sensor integration)	1 year	3 months
Frequency of Readings	5 min (realtime)	15 min (retrospective)	5 min (realtime)	5 min (realtime)
Alarm Functions	Realtime high and low glucose alarm	None	Realtime high and low glucose alarm	Realtime high and low glucose alarm
Built in Traditional Meter	Included	Included	None	None
Accuracy (MARD) ⁽¹⁾	9.1%	12.1%	9.1-10.6%	9.0%
Picture				

Note:

- (1) MARD refers to the mean absolute relative difference, which is the average value of the absolute error between the CGMS detection value and the referenced value. The lower the value, the higher the accuracy.

Source: CIC Report

CGMS can also assist in scenarios where monitoring irregular glucose fluctuation is required or recommended, such as health precaution. As a result, there has been a growing trend for expanding the application of CGMS in these fields. Besides AiDEX G7, we are leveraging our proprietary technologies to develop the second-generation calibration-free CGMS – AiDEX X to better address such untapped opportunities. AiDEX X is designed for non-intensive diabetics, pre-diabetics, and health-aware non-diabetic users, who focus more on ease of use, cost-efficiency and ultra-portability. We believe that by synergistically addressing

BUSINESS

different target populations, AiDEX G7 and AiDEX X will complement each other, and will allow us to deploy a portfolio approach, enabling rapid market penetration and wide user coverage. Our CGMS products will also constitute as an essential component of our closed loop artificial pancreas.

Forerunner in designing and developing the artificial pancreas by integrating insulin pump and CGMS with AI-optimized algorithms

We had initiated the design and the development of our first closed loop solution, the artificial pancreas, as of the Latest Practicable Date. When approved, our artificial pancreas will likely become the world’s first closed loop solution that integrates the self-developed calibration-free CGMS and patch insulin pump system.

Artificial pancreas has long been viewed as one of the disruptive solutions to the monitoring, treatment and management of diabetes. Deployed by a series of control algorithms, an artificial pancreas effectively combines the insulin pump and CGMS to monitor, treat and manage the blood glucose level on a real-time and continuous basis. Instead of delivering insulin and monitoring the glucose in a static and fragmented manner, an artificial pancreas closely mimics the action of a normally-functioning pancreas, which allows a dynamic and closed loop management of blood glucose levels. Artificial pancreas enables automatic adjustments of insulin delivery guided by the continuous monitoring of glucose level. Artificial pancreas can increase the time in target glycemic range, and reduce the risk of hyperglycemia or hypoglycemia, with minimum input from the patient. According to the CIC Report, the market size of the global artificial pancreas market was US\$1.1 billion in 2020 and is expected to reach US\$6.7 billion in 2030.

Our artificial pancreas under development will be an integration of our patch insulin pump system and CGMS. Leveraging our experience and industry knowledge, we have preliminarily constructed the control algorithms, performed the multi-parameter simulation and analysis, and conducted the stress tests on the safety of such product candidate. Featuring closed loop control, we believe our artificial pancreas will fundamentally improve the monitoring, treatment and management of diabetes. We are also in the process of designing and developing a cloud-based AI-powered artificial pancreas, which will also form an integral part of our closed loop solutions. The platform will be a central repository of data collected through our CGMS on an anonymous basis. The platform will synthesize advanced analytical tools, function through data-driven, AI-powered algorithms and will be subject to continuous optimization.

BUSINESS

Integrated platform with robust R&D, manufacturing and commercialization capabilities

We have developed a deeply integrated treatment and monitoring platform with our robust research and development, manufacturing and commercialization capabilities. We are at the inflection point to further leverage such platform and improve our financial and operating performance to achieve economies of scale.

R&D

We have a strong in-house R&D team of nearly 100 staff, led by Dr. Zheng Pan, our Chief Executive Officer, who brings us nearly 20 years of industry leadership experience. Dr. Zheng has led a project under a National Major Scientific Research Program in 13th Five-Year Plan Period, namely, Construction and Application of a Cloud-based AI Diabetes Management Platform for Children and Adolescents with Diabetes. Led by Dr. Zheng Pan, our team focused on the R&D of an intelligent cognitive computed based closed loop artificial pancreas was also awarded as “Leading Innovative Team” by the Science and Technology Department of Zhejiang Province.

Over 30% of our R&D staff possess a master or doctorate degree, and they have extensive R&D experience at leading medical device companies, including Flex (or known as Flextronics), Medtronic, Johnson and Johnson, and Terumo. Among our core R&D staff, Mr. Dore Chin Mark, our vice president for engineering has over 20 years of industry experience. Mr. Dore Chin Mark has successfully led the launch of a series of medical device products overseas, and he is the inventor of more than 10 issued patents and designs in the U.S. Dr. Yu Fei, our R&D director, is an outstanding scientist in the field of bioelectric chemistry. Dr. Yu Fei has accumulated years of experience in the R&D of diabetes management medical devices. Dr. Yu Fei is the inventor of more than 10 issued patents relating to the biosignal detection. Dr. Yu Fei is also the reviewer of five leading journals, including Biosensor & Bioelectronics, IEEE Sensor and PLOS One. Our R&D team has also developed outstanding interdisciplinary capabilities in the field of mechanical engineering, electrical engineering, software engineering, communication engineering and signal processing, electrochemistry, biomedical engineering and mathematics (algorithm) and artificial intelligence.

Externally, we have built long-standing relationship with industry KOLs including well-known medical professionals and clinical experts. We leverage their meaningful insights and recommendations to steer our R&D process towards the unmet clinical needs. Our long-term collaborations with leading universities and research institutions also enable us to cultivate a high-quality talent pool, and explore frontier and breakthrough technologies.

In recognition of our strong R&D capability, we were designated as the Key Diabetes Research Center in Zhejiang Province, China. Equil was designated as an Innovative Medical Device Product by the PRC Ministry of Science and Technology. AiDEX G7 has been certified by the NMPA in May 2020 to be eligible for the Special Approval Procedures of Innovative Medical Devices promulgated by the NMPA.

BUSINESS

Manufacturing

Since our inception, we have focused on building our internal manufacturing capabilities that meet rigorous international standards. We have accumulated extensive expertise and know-how in manufacturing medical devices and IVD medical devices. As of the Latest Practicable Date, we owned manufacturing facilities with an aggregate area of approximately 15,000 sq.m. in Hangzhou, China, including a 1,500 sq.m. ISO Class 7 clean-room space and an 80 sq.m. ISO Class 8 clean-room space, for the production and pre-delivery inspection of our products. We have received major international certifications for our manufacturing quality management, demonstrating our manufacturing capabilities and commitment to high quality. Our manufacturing facilities comply with the GMP requirements, and our quality management system conforms to the ISO 13485 standard, among others.

By internally designing, implementing and optimizing our manufacturing processes and procedures leveraging our accumulated know-how, we are able to monitor and continuously improve the manufacturing efficiency and quality, and achieve significant cost advantages. Furthermore, we have also implemented a series of automation initiatives throughout the entire manufacturing process. The automatic and continuous control of our manufacturing processes significantly contributes to the improvement of our overall production quality and efficiency. We believe our ability to deliver safe and high quality products also enables us to accelerate product registration and expand our market reach in China and globally.

Commercialization

We strategically use a combination of our in-house sales and marketing team and a broad network of independent distributors to market our products. We had over 120 in-house sales and marketing personnel as of the Latest Practicable Date. Our core sales personnel have on average more than 15 years of experience working in the relevant field.

In addition, we had built a network of 370 distributors as of December 31, 2020, covering the sales of our products across 30 provinces, municipalities and autonomous regions in China, and over 60 countries in Asia Pacific, South Asia, Europe, Middle East, Africa and Latin America. We developed a long-term collaboration with leading distributors, which enables us to expand the sales channel for our products in a precise and rapid manner.

We leverage our diversified commercialization approach to generate greater market demand of our products:

- *User-centric and clinical-data-driven promotion.* To promote the knowledge of the clinical benefits of our products and enhance our brand awareness, we deeply engage with healthcare professionals and patients by providing on-site demonstration, training and education programs using our products. Once a product has been launched, our sales team and distributors continue to gather timely clinical feedbacks through regular visits and follow-up communications, which facilitates the ongoing upgrade of our products. To share our clinical findings and showcase the

BUSINESS

benefits of our products, we also regularly organize and attend educational symposia, conferences and seminars, and other activities at national, regional and local levels, that gathered leading KOLs and experts focused on the treatment of diabetes, including the International Congress of Immunology of Diabetes Society, China Diabetes Society Annual Meeting and Endocrinology Society of China Annual Meeting.

- *Collaboration with commercial insurers.* We are seeking to collaborate with leading commercial insurers, such as Taikang Insurance Group Inc., to expand diabetes patients’ access to our advanced diabetes monitoring, treatment and management products. We believe this approach will not only ramp up our market share and gain significant pricing flexibility, but also improve the overall prevention and treatment penetration among diabetes population. As additional products from our pipeline are registered in China, we also intend to seek national insurance coverage to further increase market access.

We believe our commercialization capabilities and efficiencies have strengthened throughout the process. As of the Latest Practicable Date, Equil had been sold or distributed into 747 hospitals in China. Shortly after AiDEX G7 obtained CE marking in September 2020, we completed the first shipment of AiDEX G7 to Europe.

Visionary management team of industry veterans and industry-leading investors

We believe that our success attributes to our management’s leadership and expertise, which cover the full spectrum of the medical device development cycle of design, clinical development, manufacturing and commercialization, as well as the continuous support from industry leading investors.

Dr. Zheng Pan, our Chief Executive Officer, has nearly 20 years of experience in the healthcare industry with a solid track record in designing and developing innovative medical devices. Dr. Zheng Pan has dedicated his career to applying breakthrough technologies to medical devices indicated for diabetes treatment and management. Dr. Zheng Pan is supported by a management team of industry veterans. Dr. Yu Fei, our R&D director, Mr. Dore Chin Mark, our vice president for engineering, and Mr. Lan Yi, our vice president for sales have on average 20 years of experience in the relevant field. Prior to joining us, they have served on various management positions at major pharmaceutical and medical device companies, such as Eli Lilly, Johnson & Johnson, Medtronic and Flex (also known as Flextronics). In addition, we have a growing pool of high-quality talent to support our seasoned management team in achieving our mission.

BUSINESS

Since our establishment, we have received investments from industry-leading investors, including strategic investors Tencent and Taikang, and financial investors such as Lilly Asia Venture, Qiming Venture Partners, IDG Capital, 3H Health and CICC Pucheng. This strong investor base is a testament to our vision and capabilities. These investors have also provided strategic advice and guidance to our research and development and the operational management.

OUR STRATEGIES

Our objective in the mid-term is to leverage our strengths in patch insulin pump system and CGMS to continue to grow sales, develop and launch our closed loop solutions, increase our brand awareness and expand our global footprint. In the long term, we aim to build a cloud-based diabetes management platform to bring clinical and commercial benefits to diabetes patients all over the world. To achieve these objectives, we intend to pursue the following strategies.

Advance diabetes monitoring, treatment and management around the globe with our diversified product portfolio

We are the only company that has commercialized both patch insulin delivery system and calibration-free CGMS in the world, according to the CIC Report. We intend to broaden our pipeline through indication expansion, advance and upgrade our current products, and continue to seek regulatory approval of our products in China, the U.S., Europe and other key geographies.

We will pragmatically evaluate indication expansion and perform subsequent clinical development that will expand the labels of our products. Currently, we are seeking to expand the use of Equil and AiDEX G7 to children and adolescents with diabetes. We expect to complete the registrational clinical trials in China and submit the relevant registration applications to the NMPA in the second half of 2021. As part of the further R&D of Equil, we intend to invest in the development of our second-generation patch insulin pump system, which is designed to have smaller size, reliable waterproof performance, better adaptability and improved user-friendliness. Meanwhile, we are developing AiDEX X, a CGMS designed for non-intensive diabetics, pre-diabetics and health-aware non-diabetic users. We have completed the feasibility analysis of our second-generation patch insulin pump system and AiDEX X. We expect to complete the relevant registrational clinical trial and submit the relevant registration application to the NMPA for our second-generation patch insulin pump system and AiDEX X in the first half of 2023 and the second half of 2022, respectively.

Furthermore, we will continue developing our closed loop solutions, in particular, artificial pancreas, which will provide an integrated solution for the monitoring, treatment and management of diabetes. We will equip our second-generation patch insulin pump system with control algorithms, which, together with our CGMS, is expected to form the bedrock of our closed loop artificial pancreas. We are currently testing our proprietary control algorithms, and aim to initiate the registrational clinical trial for our closed loop artificial pancreas in the first

BUSINESS

half of 2022 in China, and a registrational clinical trial in the U.S. is also under plan. We expect to title our products, in particular, our closed loop solutions, including the artificial pancreas, with high class of recommendation and level of evidence in relevant guidelines published by authorities in China, the U.S. and the EU.

We will continue to improve and expedite the introduction of our patch insulin pump system and CGMS to major markets. We completed a clinical trial for AiDEX G7 in China in May 2020 and the NMPA has accepted our registration application in the first quarter of 2021. AiDEX G7 has been certified by the NMPA in May 2020 to be eligible for the Special Approval Procedures of Innovative Medical Devices promulgated by the NMPA. When approved, AiDEX G7 is expected to be the first calibration-free real-time CGMS approved for commercialization in China. We are seeking the FDA approval of Equil for the treatment of diabetes in adult patients, and the registration application has been filed with the FDA in February 2021. We plan to continue our clinical and academic efforts, including through post-launch studies, after receiving the marketing approval for our existing and future products.

Continue to develop our multidisciplinary R&D capabilities and address the evolving clinical demands

To solidify our industry leadership and competitiveness, we plan to continue developing our R&D capabilities through a multidisciplinary approach and integrate advanced technologies in the field of material science, microfabrication, bioinformatics, cloud-based computation and artificial intelligence. We have strategically established and will maintain and expand our partnerships with leading universities and science and technology institutes. For example, we have jointly established the Flexible Electronics Joint R&D Center with Zhejiang University. We anticipate these efforts will deepen our technology research in diabetes management medical devices and bring tangible results in the future.

In parallel, we will augment our translational research to expedite our bench-to-bedside development process, transforming latest technological advancement into clinically validated solutions. Our collaborations with major research-oriented hospitals, diabetes research institutions will provide us with visibility into the clinical potentials of our product pipeline. We will also maintain periodic communications with industry KOLs and frontline medical practitioners. We believe their first-hand feedback on unmet clinical needs will pivot our product development and upgrade, and allow us to adopt effective marketing strategies to address the evolving clinical demands in a timely manner. In addition, we will continue to launch research funds and encourage researchers and physicians to explore the use of our technologies in new clinical applications and therapies and facilitate our continuing product pipeline expansion.

BUSINESS

Continue to expand our global footprint through a user-centric and clinical-data-driven sales strategy and a diversified commercialization channel

We are committed to sales and marketing through a highly specialized in-house sales and marketing team and a strong global distribution network covering the sales of our products across 30 provinces, municipalities and autonomous regions in China, and over 60 countries in Asia Pacific, South Asia, Europe, Middle East, Africa and Latin America.

We will continue to expand our global footprint by recruiting high-caliber sales staff with extensive local experience. For example, our current EU sales director has nearly 20 years of experience in the marketing of diabetes management medical devices in Europe, who also has an in-depth knowledge of continuous glucose monitoring and CSII therapy. We believe these industry veteran will enable us to fully unlock the potential commercial value of our products in major markets. Furthermore, we will explore opportunities to maintain and establish long-term cooperation with leading distribution partners who have strong local network, on-the-ground experience and knowhow to complement and further strengthen our market presence.

We strive to implement and enhance our user-centric and clinical-data-driven sales strategy. We plan to retain strong relationship with industry KOLs, as we believe that a strong relationship with KOLs will be important in influencing hospital or users’ buying decisions. We will continue to actively organize and participate in academic conferences and activities and utilize scientific presentations and publications to drive the awareness of our brand and products. In light of the chronic nature of diabetes, we will focus on rendering continuous supports to healthcare professionals and patients. These clinical feedbacks are critical to launching high-quality products and bring optimal clinical outcomes to the population suffering from diabetes or abnormal glucose level.

Furthermore, we will continue to diversify our commercialization channel by garnering appropriate reimbursement and insurance coverage of our products, including through collaboration with Taikang and other commercial insurance partners and public insurance programs. Such effort will reduce patients’ cost, and increase our market penetration without compromising the quality of our care.

Continue to increase our manufacturing capacity to support our growth and achieve economies of scale

We are committed to continuously expanding our manufacturing facilities and improving our quality management system. We will continue to design and establish our manufacturing facilities and production lines in accordance with international standards, invest in state-of-the-art manufacturing equipment, and automate production capabilities to better address market demand while capturing economies of scale. We have been upholding and will continue to uphold a high standard of quality. Our manufacturing systems have obtained GMP certifications and complied with requirements by competent authorities. We plan to leverage our strong track record and experience to obtain additional certifications and adopt advanced standards for ongoing overseas expansion.

BUSINESS

Build a cloud-based diabetes management platform to enable the formulation of personalized diabetes solutions and a closed loop diabetes management ecosystem

Aside from leveraging our enriched and diversified portfolio to reshape the diabetes management paradigm through innovating and integrating the treatment and monitoring of diabetes, we also strive to build a cloud-based diabetes management platform to provide continuous, proactive and personalized diabetes management solutions worldwide. We believe clinical data and insights accumulated through the growing use of our products are not only useful to the R&D of our closed loop solutions, but also of great value for optimizing the outcome of diabetes treatment and management. However, mismatch between the sheer amount of data available and the limited time frustrates the ability of physicians to offer personalized and in-depth analysis remains unsolved.

To address this challenge, we intend to develop and continuously optimize a cloud-based diabetes management platform, utilizing artificial intelligence, big data analytics and cloud computing technologies. We believe a platform empowered by these advanced technologies will facilitate the effective organization and evaluation of the vast amount data and information. Relying on such platform, we will be able to create a closed loop diabetes management ecosystem to improve the quality of care for patients with diabetes, increase our market penetration, and enhance user stickiness.

OUR PRODUCTS AND PRODUCT PIPELINE

We are a pioneer in the diabetes management medical devices industry that innovates and integrates the treatment and monitoring of diabetes to reshape the diabetes management paradigm in China and globally. We have a comprehensive product portfolio for diabetes monitoring, treatment and management, across multiple product lines, including patch insulin pump system and CGMS, which form the basis of the closed loop artificial pancreas, as well as IVD devices, such as BGMS and POCT devices. As of the Latest Practicable Date, all of our products and product candidates were self-developed and did not involve in-license arrangements with third-parties. Equil, our patch insulin pump system, was approved by the NMPA as a Class III medical device and constitutes our Core Product for purposes of this Document. Our product candidates are subject to approval by relevant authorities in China, the U.S. and the EU, before commercialization in relevant jurisdiction. For details, see “Regulatory Overview.” As of the date of this Document, we had not received any material comments or concerns raised by the relevant regulatory authorities with respect to our Core Product that we are not able to address in a timely manner, and we believe we are on track to file for approval related to our product candidates as described in “—Our Products and Product Pipeline.”

BUSINESS

Equil – Core Product

Our Core Product Equil is a tubeless patch pump worn directly on the body that combines the pumping mechanism and infusion set in a small wearable package. Patch pumps are controlled wirelessly by a separate device that allows programming of basal rate of infusion and bolus insulin for meals and other activities to the tubeless patch pump.

In contrast, a traditional tubed pump has a pumping mechanism combined with an insulin reservoir that delivers insulin through a long tube into an infusion set worn on the body. The large pump body contains buttons that allow the users to program bolus insulin for meals or high glucose correction, to specific basal rates for background insulin, or to suspend the insulin infusion altogether, if necessary. Equil received CE marking in Europe in June 2017 and the marketing approval by the NMPA, for adult use, in China in September 2017. We started to commercialize Equil in China and Europe in 2018. During the Track Record Period, the retail price of our Equil in China was RMB28,800 per unit. We have submitted a 510(k) premarket notification for Equil to the FDA in February 2021, and we expect to receive the FDA clearance in the first half of 2022. We are preparing for a pivotal clinical trial for purposes of registering Equil for children and adolescents’s use. We will also continue developing our second-generation patch insulin pump system and artificial pancreas, with Equil serving as an essential component. See “—Research and Development Plans.”

Product Design and Technology

Equil patch insulin pump system primarily consists of a discreet patch pump and a wireless portable diabetes assistant (“**PDA**”), which can eliminate the inconvenience of the external tubing required by a traditional tubed pump and reduce the risk of therapy obstructions caused by external tubes being kinked, bent or pulled.

- Patch pump – a small, lightweight, wearable, semi-disposable device integrating an insulin reservoir, delivery system, and cannula. The patch pump can be attached to multiple body sites and can be easily hidden beneath clothing, which addresses the discreetness concerns of users and provides great convenience. The patch pump enables users to dose insulin precisely based on personalized needs; and
- PDA – a handheld remote control device that wirelessly sends programs and commands to the patch pump. Users can initiate personalized basal programs and bolus deliveries using the easy-to-read touchscreen interface, and then send the desired commands wirelessly to the patch pump for execution. The PDA also wirelessly monitors the patch pump’s operation and status.

BUSINESS



Equil provides continuous insulin delivery at preset rates and can be worn for several days, avoiding the pain caused by conventional multiple daily injection (“MDI”) therapy. In addition, insulin delivery can be changed by swiping on touchscreen or with the press of a dedicated bolus button on the pump body without the remote control to adapt to snacks or unexpected changes in daily routine.

Equil is designed to fit within the normal daily routines of users. It mimics the normally-functioning human pancreas by delivering insulin in three ways:

- basal insulin – a small, continuous infusion of background insulin delivered automatically at a programmed rate, all day and night;
- meal bolus insulin – a rapid dose of insulin delivered to counteract high blood glucose levels resulting from ingesting carbohydrates during mealtime or snacktime; and
- correction bolus insulin – an extra rapid dose of insulin to correct high blood glucose levels not associated with meals.

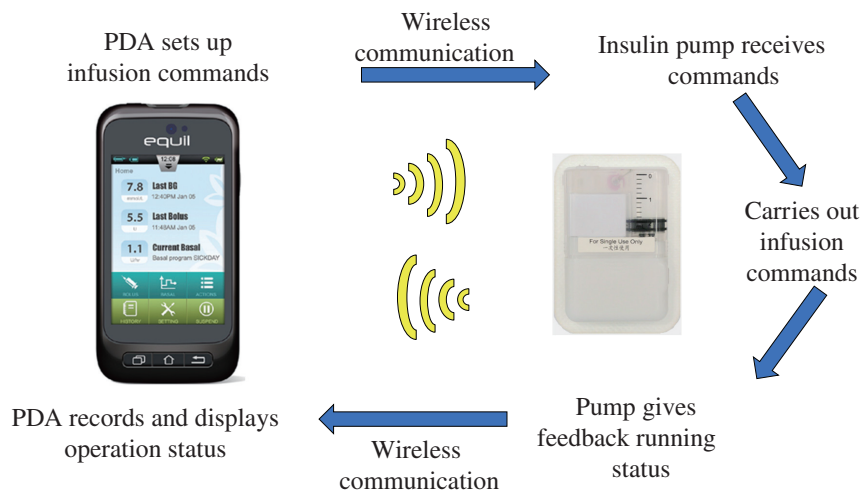

BUSINESS

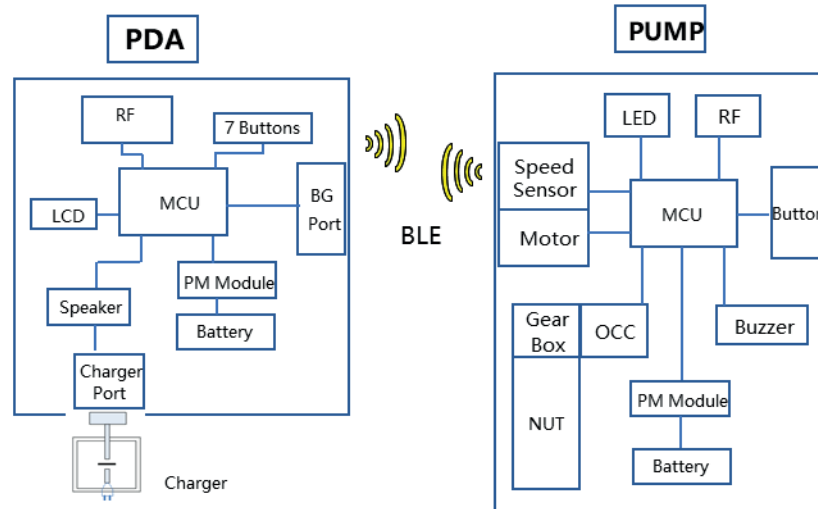

We believe that Equil is a top-notch patch insulin pump system with better or comparable features than the commercialized peer products, as illustrated in the chart below:

Company Product name	The Company Equil	Insulet Omnipod-Dash System
Pump	Semi-disposable	Disposable, one-time use
Bolus button	Yes	No
Alarms	Patch pump: LED and vibration Remote: LED, sound, and vibration	Pod: LED and sound Remote: LED and sound
Convenience	The pump body can be removed from the body as needed, and can be reattached	Pod cannot be reused if removed from the body
Regulatory	Compliant with applicable NMPA regulations	Adjustments may be required to comply with applicable NMPA regulations
Delivery specs	Minimum step size: 0.025U	Minimum step size: 0.050U

Source: CIC Report

We believe the above features make Equil attractive to people with insulin-dependent diabetes and allows healthcare professionals to prescribe pump therapy to a broader group of people.

Market Opportunity and Competition

Diabetes is one of the most prevalent chronic diseases, which is often ill-managed due to lack of effective insulin delivery and glucose monitoring. The global prevalence of diabetes was 486.9 million people in 2019, and is expected to reach 607.6 million people in 2030, according to the CIC Report. The prevalence of diabetes in China was 118.8 million people in 2019 and is expected to reach 143.2 million people in 2030, according to the CIC Report.

BUSINESS

Insulin is one of the most widely used drugs to treat diabetes. For Type 1 diabetes treatment, it is necessary to use insulin, and there are two types of insulin therapy, MDI therapy and CSII therapy. Insulin infusion treatment is also one of the major treatment methods for Type 2 diabetes.

The market size of diabetes treatment medical devices market in China increased from US\$0.3 billion in 2015 to US\$0.9 billion in 2020, at a CAGR of 21.0% and is expected to further increase to US\$3.6 billion in 2030, at a CAGR of 15.1% from 2020 to 2030, according to the CIC Report. The market size of diabetes treatment medical devices market globally increased from US\$10.4 billion in 2015 to US\$14.5 billion in 2020, at a CAGR of 6.8%, and is expected to further increase to US\$38.0 billion in 2030, at a CAGR of 10.1% from 2020 to 2030, according to the CIC Report.

According to the classification of insulin delivery methods, diabetes treatment devices can be mainly divided into insulin pumps, insulin pens, insulin syringes, among others. Given the multiple advantages of insulin pump, it has been more widely adopted for diabetes treatment and its market share among diabetes treatment medical devices also increased. Currently, tubed insulin pumps and tubeless patch insulin pumps are the two main types of insulin pumps. Patch insulin pumps have been shown to be significantly better than the traditional tubed insulin pump, featuring tubeless, smaller device size, greater portability and better patients’ adherence to treatment regimens. The market size of insulin pumps market in China increased from US\$58.1 million in 2015 to US\$125.4 million in 2020, at a CAGR of 16.6%, and is expected to further increase to US\$1.0 billion in 2030, at a CAGR of 23.3% from 2020 to 2030, according to the CIC Report. The market size of the global insulin pumps market increased from US\$4.1 billion in 2015 to US\$5.6 billion in 2020, at a CAGR of 6.6%, and is expected to further increase to US\$20.7 billion in 2030, at a CAGR of 14.0% from 2020 to 2030, according to the CIC Report.

According to the CIC Report, as of the Latest Practicable Date, Equil was the second commercialized semi-disposable patch insulin pump globally, and the first and only domestically developed patch insulin pump approved in both China and the EU. Equil is significantly more portable and user-friendly than the traditional tubed pump. The following table sets forth the comparison of the insulin pump products by major manufacturers in China as of the Latest Practicable Date.

Insulin pump products by major manufacturers in China

Manufacturer	The Company	Medtronic	SOOIL	Fornia	Phray
Product name	Equil	MiniMed	DANA Diabecare	IP-101	Ph300
Approval time	2017.9	2011.12	2008.2	2003.10	2013.4
Applicable population	Adults with diabetes	Patients with diabetes who need to be treated with insulin infusion	Adults and children with diabetes	Patients with diabetes who need to be treated with insulin infusion	Patients with diabetes who need to be treated with insulin infusion
Type	Patch pump	Tubed pump	Tubed pump	Tubed pump	Tubed pump
Capacity of insulin reservoir	200U	300U	300U	300U	305U

Source: CIC Report

BUSINESS

The following table sets forth the comparison of the insulin pump products by major manufacturers in the global market as of the Latest Practicable Date.

Insulin pump products by major manufacturers in the global market

Manufacturer	The Company	Insulet	Roche	Medtronic	Tandem Diabetes Care
Product	Equil	Omnipod	Accu-Chek Solo	MiniMed	t:slim
Marketed regions	China, EU	The U.S., EU	EU	China, the U.S., EU	The U.S., EU
Applicable population	Adults with diabetes	Adults and children with diabetes	Adults with diabetes	Diabetic patients over 16 years old	Diabetic patients over 6 years old
Type	Patch pump	Patch pump	Patch pump	Tubed pump	Tubed pump
Duration	Several years	Three days	Four months	Several years	Several years
Weight without battery	23g	25g	29g	≤106g	112g (Equipped with rechargeable battery)
Is the pump body reusable or not	√	×	√	√	√
Capacity of insulin reservoir	200U	200U	200U	300U	300U

Source: CIC Report

The following table sets forth the major insulin pump products under development in the global market as of the Latest Practicable Date.

Major insulin pump products under development in the global market

Manufacturer	Product	Type	R&D progress	Product features
Medtronic	MiniMed780G	• Tubed pump	• Pending FDA approval	<ul style="list-style-type: none"> • Auto-correction every 5 mins, as needed 24/7 • Can work with Medtronic’s CGM sensor Zeus to function as artificial pancreas
Tandem	t:sport mini-pump	• Tubed pump	• Pending FDA approval	<ul style="list-style-type: none"> • Half the size of the previous generation • No display screen
Insulet	Omnipod Horizon	• Patch pump	• Pending FDA approval	<ul style="list-style-type: none"> • Can be controlled by smartphone app • Conduct automated insulin delivery • Can work with CGMS to function as artificial pancreas
BD	Patch Pump for T2	• Patch pump	• Completed clinical trials	<ul style="list-style-type: none"> • New disposable, three-day wearable tubeless pump • Provides basal and bolus dosing • Comes with reusable handheld controller and connects to smartphone app via Bluetooth

Source: CIC Report

BUSINESS

Summary of Clinical Trial Results

We have completed a multi-center, open-label, randomized, parallel positive control, non-inferiority validation clinical trial in China to evaluate and compare the safety and efficacy of Equil with MiniMed Paradigm 712 insulin pump ("**MiniMed**"), a conventional pump, involving 152 subjects (22 subject were excluded or fell out). The trial started in August 2014 and was completed in October 2015. We conducted the trial in three sites and subjects were assigned to use Equil or MiniMed randomly on a one to one ratio. The primary efficacy indicator evaluated was the seven finger stick blood glucose values on the sixth day and the primary safety indicator evaluated was the incidence of adverse events, severity and correlation in using Equil. The clinical trial results showed that neither the blood glucose compliance rate nor cannula success rate in the trial group (using Equil) is inferior to that of the control group (using MiniMed).

The final statistical analysis set of this trial consisted of 136 cases of modified intent-to-treat population ("**MITTP**"), of which 66 cases were in the trial group and 70 were in the control group, and 130 cases were in the per-protocol population ("**PPP**"), of which 66 cases were in the trial group and 64 cases in the control group.

Efficacy Results

The primary efficacy evaluation indicator in the MITTP, namely the blood glucose compliance rate of trial group, was 77.2%, higher than 57.14% of the control group. The 95% confidence interval was (4.31%, 34.53%), with its lower limit of 4.31% higher than the non-inferiority effect boundary value of -10% set by the study, and the results show that the blood glucose compliance rate of the trial group is not inferior to the control group with statistical significance (P=0.013).

The cannula success rate of the trial group is 98.51% and the control group is 100%. The 95% confidence interval was (-5.28%, 3.38%), with its lower limit of -5.28% higher than the non-inferiority effect boundary value -10% set by the study. The results show that the cannula success rate of the trial group is not inferior to the control group. The conclusions from analyzing both PPP and MITTP data were consistent.

The secondary efficacy evaluation indicators in the MITTP, namely, the difference between trial group and control group in terms of insulin pump failure rate, hypoglycemia occurrence rate, hyperglycemia occurrence rate, total insulin dosage, daily average blood sugar and blood fluctuation was not statistically significant. The conclusion from analyzing both PPP and MITTP data were consistent.

Safety Results

A total of 27 subjects in this trial had a critical blood sugar event (hyperglycemia and hypoglycemia symptoms that occurred), in which 14.47% occurred in the test group, and 21.05 % occurred in the control group. A total of 78 cases of adverse events (adverse events other than critical blood sugar events, such as dizziness, constipation and bacterial infection) occurred, in which 56.58 % occurred in the test group, and 46.05% occurred in the control

BUSINESS

group. A total of 3 cases of serious adverse events occurred and all of them were in the control group. There was no statistically significant difference in critical blood glucose value, incidence of adverse events (including serious adverse events), severity, and device correlation between the two groups.

Research and Development Plans

Expansion to Use by Children and Adolescents

We are preparing for a pivotal multi-center, open-label, randomized, cross-over, noninferiority validation clinical trial to expand the use of Equil to children and adolescents (aged 3 to 18 years old) with diabetes. As of the Latest Practicable Date, we had determined the principal investigator and engaged the SMO, finalized the clinical trial protocol, completed the ethics committee review, and recorded with target hospitals for performing the clinical trial. We are currently in the process of executing the agreements with target hospitals to perform the clinical trials and providing relevant trainings to physicians and nurses, which we expect to take two months.

We anticipate to enroll patients and commence the clinical trial in the first half of 2021. The test subjects will be children and adolescents (aged 3 to 18 years old) with diabetes. We plan to enroll 74 subjects at 10 different clinical sites, and we expect the patient enrollment process to take three months. The primary efficacy indicator to be evaluated will be mean blood glucose and the primary safety indicator to be evaluated will be incidence of adverse events, severity and correlation in using different devices. We expect to complete the registrational clinical trial in China and submit the registration application to the NMPA in the second half of 2021.

We communicated with the NMPA regarding the clinical trial for such indication expansion in July 2020, and then filed the clinical trial record with the local counterpart of the NMPA in the same month.

Second-Generation Patch Insulin Pump System

The second-generation patch insulin pump system will be built on the technology infrastructures of Equil, including the proprietary drive system, sensors, software, algorithm, architecture and accessories. On such basis, the second-generation patch insulin pump system will feature smaller size, improved waterproof performance, more convenient battery charging mechanism, better adaptability to insulin reservoirs with a capacity of up to 300U.

We have completed the feasibility and market research in the first quarter of 2021. We are currently working on the design of our second-generation patch insulin pump system, which is expected to take three months. We anticipate to complete the engineering verification in the second half of 2021. Thereafter, we plan to initiate communications with the NMPA for the next steps, including seeking the NMPA certification on the eligibility of Special Approval Procedure for Innovative Medical Devices, as well as submitting samples to the local counterpart of NMPA for the official type testing. We will also communicate with the NMPA

BUSINESS

and clinical experts with respect to the clinical trial design. We plan to initiate the clinical trial in the first half of 2022. We expect to complete the registrational clinical trial and submit the registration application to the NMPA in the first half of 2023.

Artificial Pancreas

Leveraging our advanced technologies in the development of patch insulin pump system and CGMS, we are currently developing an artificial pancreas, an integrated diabetes management medical device that tracks blood glucose levels using a continuous glucose monitor and automatically delivers the insulin when needed using an insulin pump according to its control algorithm. For more information, see “—PanCares – Artificial Pancreas.”

AiDEX CGMS

AiDEX CGMS is designed to gather information about glucose levels every few minutes, allowing the user to see a graph of glucose levels rather than just a single measurement snapshot at a given point in time. Continuous glucose monitoring is potentially useful to anyone with diabetes, and is especially useful for patients undergoing MDI or receiving the CSII therapy. AiDEX G7, our first AiDEX CGMS, primarily focuses on the clinical needs of patients with Type 1 diabetes and severe Type 2 diabetes who need to closely monitor their blood glucose levels. The user of AiDEX G7 inserts a sensor that measures the glucose level of subcutaneous interstitial fluid. The sensor connects to a transmitter that beams the glucose data wirelessly to a receiver, which can be either a dedicated handheld device or a mobile phone with the relevant application installed. The sensor of AiDEX G7 can be worn for 14 days and then replaced with a new one.

As illustrated below, the real-time glucose level graph displayed by our CGMS provides detailed information on the user’s glucose fluctuation. The user can track glucose levels during specific parts of a daily routine, such as before or after mealtimes, during sleep, or during exercise. This can give the user a better awareness of his or her body’s needs throughout the day.

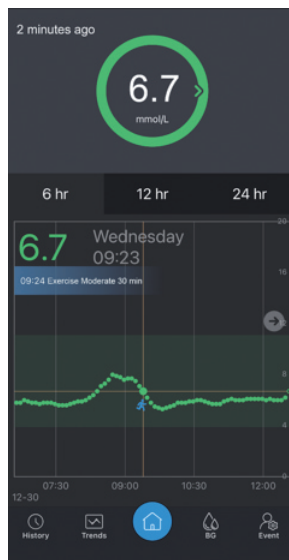

BUSINESS

AiDEX G7 received CE marking in Europe in September 2020. We started to commercialize AiDEX G7 in Europe in March 2021. We completed a clinical trial for AiDEX G7 in China in May 2020 and the NMPA accepted our registration application in the first quarter of 2021. Currently, we are in the process of developing AiDEX X, a cost-effective CGMS catering to non-intensive diabetics, pre-diabetics and health-aware non-diabetic users. For details, see “—Research and Development Plans—AiDEX X.”

Product Design and Technology

AiDEX G7 primarily consists of three components: a tiny disposable 14-day glucose sensor that is inserted subcutaneously by the user; a reusable transmitter that receives, assesses and relays data from the sensor; and a reusable receiver that receives data from the transmitter and provides real-time glucose readings, alerts and other data. All disposable components are single use and are provided in sterilized packaging. All of these components work together to provide glucose readings, trends and alerts to the user’s mobile device in real time.

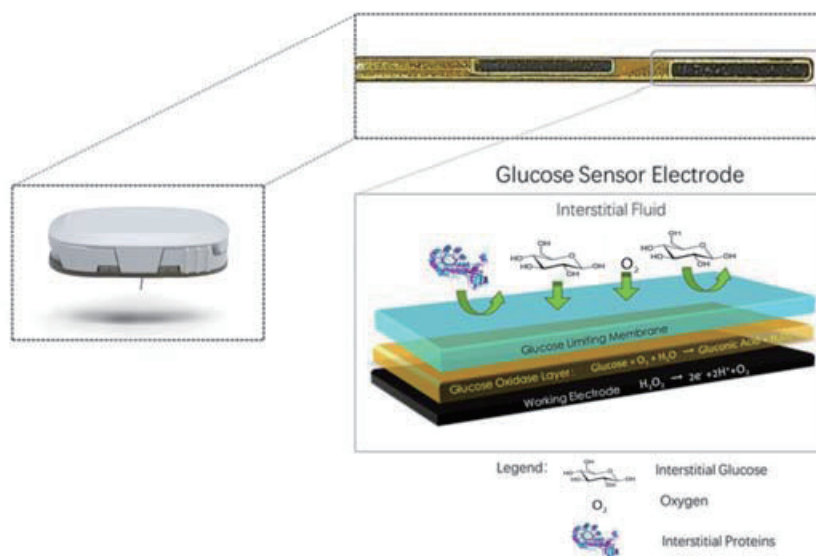

Long-lasting disposable glucose sensor

The glucose sensor is intended to be inserted under the skin, on the upper arm, abdomen in an almost painless way to measure the glucose levels in the interstitial fluid. These glucose data are collected by the transmitter and then wirelessly communicated to a standalone PDA or a mobile phone installed with the application. We have designed the sensor of AiDEX G7 to last up to 14 days, and such duration is on par with or better than other currently available continuous glucose monitoring sensors.

The glucose sensor consists of a small flexible sensing probe, and a sensor base with adhesive patch that ensures the sensor securely adheres to the skin and connected with the transmitter. The sensing probe has a working electrode that measures the interstitial fluid

BUSINESS

glucose level via glucose oxidase-mediated electrochemical reactions; it also has a dedicated interference detection electrode which ensures elimination of the noise signals from interfering substances such as acetaminophen or ascorbic acid.

Smart reusable transmitter

The transmitter of AiDEX G7 is powered by a disposable battery built into the sensor and does not need to be recharged. After the transmitter is snapped onto the sensor, the electrochemical signal generated by the sensor will be relayed to the transmitter. The transmitter uses current/impedance dual-mode monitoring technology to automatically and intelligently correct blood glucose calculations. The transmitter generates a blood glucose reading every five minutes and sends a signal via Bluetooth. The information from the transmitter is also transmitted for display to the user’s mobile device, leveraging Bluetooth low energy (“BLE”) technology.

Receiver

Users can set up, control or read data from AiDEX CGMS either through a mobile phone installed with relevant iOS or Android applications or a standalone PDA.

Mobile phone (installed with application)

Our mobile app communicates with the transmitter through BLE and obtains blood glucose data from the transmitter. The application installed on the user’s mobile phone can display current blood glucose readings and trends in a user-friendly fashion. The application can also display statistical data, such as the user’s aggregated glucose profiles, average blood glucose level in the last seven days, 14 days, or 30 days, the frequency and duration of high and low blood glucose events. The application can alert users with sounds and vibrations, when AiDEX CGMS detects high/low blood glucose and rapid blood glucose rises/falls. Users can also calibrate the transmitter through the application and record their exercise, diet, medication and insulin infusions. The user can opt to share his or her glucose data with others, such as family members or healthcare providers.

PDA

Users can use a standalone PDA as an alternative, which provides similar functions as the mobile application, except that certain ancillary functions, such as daily activity record and cloud storage, are not available. However, the PDA has a customized and dedicated system that has been thoroughly tested alongside the AiDEX CGMS glucose sensor and the transmitter, which is expected to provide more predictable performance than the mobile application.

BUSINESS





Market Opportunity and Competition

Diabetes monitoring medical devices can be classified as traditional BGMS, CGMS and others, such as HbA1C and ketones testing. For the prevalence of diabetes in China and globally, see “—Equil – Core Product—Market Opportunity and Competition.” The market size of diabetes monitoring medical devices market in China increased from US\$0.5 billion in 2015 to US\$1.3 billion in 2020, at a CAGR of 22.7%, and is expected to further increase to US\$6.1 billion in 2030, at a CAGR of 16.8% from 2020 to 2030, according to the CIC Report. The market size of the global diabetes monitoring medical devices market increased from US\$17.4 billion in 2015 to US\$26.8 billion in 2020, at a CAGR of 9.0%, and is expected to further increase to US\$73.8 billion in 2030, at a CAGR of 10.7% from 2020 to 2030, according to the CIC Report. For advantages of CGMS over traditional BGMS, see “Industry Overview—Diabetes Monitoring Medical Devices Market—CGMS Market.”

The CGMS market is fast-growing and CGMS products are witnessing a wider acceptance. Moreover, with people’s increasing healthcare awareness, the penetration rate for CGMS is expected to experience a significant growth in the future. In China, for Type 1 diabetes, the penetration rate of CGMS was 6.9% in 2020 and is expected to further increase to 38.0% in 2030; for Type 2 diabetes, the penetration rate of CGMS was 1.1% in 2020 and is expected to further increase to 13.4% in 2030, according to the CIC Report.

Due to the advantages of CGMS compared with traditional BGMS and the rising acceptance of patients, the market size of the CGMS market in China is expected to increase from US\$0.1 billion in 2020 to US\$2.6 billion in 2030, at a CAGR of 34.0%, according to the CIC Report. The market size of the global CGMS market is expected to increase from US\$5.7 billion in 2020 to US\$36.5 billion in 2030, at a CAGR of 20.3%, according to the CIC Report. The following tables set forth the major marketed CGMS products in the global market as of the Latest Practicable Date.

Global major marketed CGMS products

Performance	The Company’s AiDEX G7	Abbott Freestyle Libre ProFlash	Medtronic Guardian	Dexcom G6
Calibration	Calibration-free	Calibration-free	Twice per day	Calibration-free
Usage Time	14 days	14 days	7 days	10 days
Startup Time	1 hour	1 hour	2 hours	2 hours
Transmitter Life	4 years	1 year (sensor integration)	1 year	3 months
Frequency of Readings	5 min (realtime)	15 min (retrospective)	5 min (realtime)	5 min (realtime)
Alarm Functions	Realtime high and low glucose alarm	None	Realtime high and low glucose alarm	Realtime high and low glucose alarm
Built in Traditional Meter	Included	Included	None	None
Accuracy (MARD) ⁽¹⁾	9.1%	12.1%	9.1-10.6%	9.0%
Picture				

Note:

- (1) MARD refers to the mean absolute relative difference, which is the average value of the absolute error between the CGMS detection value and the referenced value. The lower the value, the higher the accuracy.

BUSINESS

The following tables set forth the major CGMS products under development in the global market as of the Latest Practicable Date.

Global major CGMS products under development

Manufacturer	Product	R&D progress	Product Features
The Company	AiDEX G7	Pending NMPA approval	Calibration-free Real-time monitoring Usage time: 14 days
Dexcom	G7	Pending FDA approval	Calibration-free Smaller than G6 Usage time: 10 days
Abbott	Libre 3	Pending FDA approval	Calibration-free Real-time monitoring Smaller than Libre 2 Usage time: 14 days
Senseonics	Eversense 180-day	Pending FDA approval	1 time per day calibration Real-time monitoring Usage time: 180 days
Medtronic	Zeus	Completed pivotal trial	Need calibration on the first day Usage time: 7 days
WaveForm Diabetes	Cascade	In clinical trial	1 time per day calibration Real-time data monitoring Usage time: 14 days

Source: CIC Report

Summary of Clinical Trial Results

From July 2019 to May 2020, we conducted a pivotal, multi-center, randomized, paired-design validation clinical trial in China. All subjects who participated in this trial were divided into two groups: the outpatient group and the inpatient group. Both groups wore AiDEX G7 for 14 days continuously. All subjects were randomly assigned to participate in an eight-hour supervised observation session where blood samples were collected every 15 minutes. We enrolled 120 subjects, with 120 cases included in the full analysis set (“**FAS**”), 90 cases included in the per-protocol set (“**PPS**”), and 120 cases included in the safety set, or SS.

The primary efficacy evaluation indicators include percent of results within 20% of the referenced value, mean absolute relative difference (“**MARD**”) compared with referenced value, among others. The secondary efficacy evaluation indicators include high and low glucose alert performance, glucose sensor stability, glucose sensor use life and glucose sensor usability. In order to evaluate efficacy indicators, investigators compared the blood glucose values measured by AiDEX G7 with the venous blood glucose values measured by Yellow Spring Instrument (YSI) as references. YSI is the recognized standard for laboratory analysis of blood glucose. For safety evaluation, we recorded all adverse events associated with the use of our device, and evaluated the adverse event occurrence rate and the percentage correlation.

BUSINESS

The trial device has been proven to meet the primary and secondary efficacy indicators, and safety. Therefore, this trial has verified that AiDEX G7 can be used safely and effectively on diabetes patients older than 14 years old in both inpatient and outpatient settings for continuously or periodically monitoring tissue fluid glucose levels and identifying potential hypoglycemia or hyperglycemia events.

Efficacy Results

(1) Primary efficacy indicators

The precision of the blood glucose values measured by AiDEX G7 to paired YSI values was assessed by calculating the percentage of blood glucose values measured by AiDEX G7 that were within 20mg/dL or 20% of the paired YSI reference glucose values, or 20/20% agreement with YSI reference. Point estimate of the overall 20/20% agreement rate with YSI reference of AiDEX G7 was no less than 95.46%, with lower boundary of the 95% confidence interval at 94.29%. Both values were higher than the target point estimate (>65%) and lower boundary of 95% confidence interval (>60%) set by the study as a requirement by the NMPA.

In our study, accuracy was measured by comparing the mean absolute relative difference ("MARD"), which measures the average percent disagreement between the AiDEX G7 and YSI reference. MARD indicates the average percentage disagreement between AiDEX G7 and YSI reference. The point estimate of the overall MARD of AiDEX G7 compared with YSI reference was no greater than 9.55%, with 95% confidence interval of 3.99% - 15.12%. Both values were better than the target point estimate (<18%) and upper boundary of 95% confidence interval (<20%) set by the study as a requirement by the NMPA.

(2) Secondary efficacy indicators

The high glucose alert success rate, high glucose detection success rate, low glucose alert success rate and low glucose detection success rate of AiDEX G7 were 90.57%, 95.92%, 97.37% and 86.67%, respectively. The glucose sensor stability was evaluated on different body parts and on the second, sixth to eighth, and fourteenth day after the enrollment, with all 20/20% agreement rates with YSI reference higher than the point estimate set by the study. Percentage of sensors meeting 14 days of usage time ranges from 97.78% to 100.00%. Subjects participated in this trial were overall satisfied with the use of AiDEX G7.

Safety Results

During the clinical trial, we observed a total of 60 adverse events, including one severe adverse event (in the inpatient group) unrelated to the use of the CGMS being evaluated. The adverse events that are related to the use of CGMS include blood seepage, pain after insertion, skin irritation and slight redness, which all of were eliminated after mitigation.

BUSINESS

AiDEX G7 has been certified by the NMPA in May 2020 to be eligible for the Special Approval Procedures of Innovative Medical Devices promulgated by the NMPA. We commenced the pivotal clinical trial for AiDEX G7 in China in July 2019. We had an online official communication with the NMPA in February 2021, in which the NMPA and our Company mainly discussed about the regulatory pathway of AiDEX G7 and the applicable laws, regulations and guidelines in relation to product registration. The NMPA confirmed that they had no objection if we applied for the marketing approval of AiDEX G7, following the Special Approval Procedures of Innovative Medical Devices promulgated by the NMPA. Following such communications, the NMPA accepted our registration application in the first quarter of 2021. Other than the above, we have not had any material regulatory communications with the NMPA for AiDEX G7.

Research and Development Plans

Expansion to Use by Children and Adolescents

We plan to conduct a clinical trial to expand the use of AiDEX G7 to children and adolescents with diabetes in the second half of 2021. The test subjects will include children and adolescents (aged 3 to 18 years old) with diabetes and we plan to enroll 60 subjects at three different clinical sites. We are responsible for the trial design and trial report and will engage CROs to coordinate the trial. The primary efficacy indicator to be evaluated will be the CGMS accuracy comparing to YSI reference. We expect to receive the approval for the clinical trial and complete the patient enrollment in the second half of 2021. We expect to submit the registration application to the NMPA after we complete the registrational clinical trial and obtain the registration certificate of AiDEX G7 for adult use. Such registration application is expected to take place in the second half of 2021.

AiDEX X

We are in the process developing AiDEX X, a CGMS that complements AiDEX G7 and cater to non-intensive diabetics, pre-diabetics, and health-aware non-diabetic users. AiDEX X will balance the need of a reasonable accuracy in blood glucose readings and meet the requirements of the FDA’s iCGM classification of Class II medical devices with price, convenience and comfort. AiDEX X will feature the use of new glucose sensing technology and reduced size, aseptic packaging, and usage time of no less than 15 days.

We have completed product feasibility analysis, sensing technology iteration, chip development and ID design. We plan to complete product prototype trial production and production process optimization in the second half of 2021, and complete medical device registration type testing in 2021. We expect to complete the clinical trial and submit the registration application to the NMPA in the second half of 2022.

BUSINESS

PanCares — Artificial Pancreas

The artificial pancreas is an integrated diabetes management medical device that tracks blood glucose levels using a continuous glucose monitor and automatically delivers the insulin when needed using an insulin pump according to its control algorithm. We have completed a market and feasibility research in the first quarter of 2021, and expect to complete the engineering verification of our artificial pancreas in the first half of 2022. We expect to obtain the trial approval, initiate and complete the clinical trial in 2022 and register in China, the U.S. and the EU in 2023.

Product Design and Technology

Our artificial pancreas offers patients a closed loop diabetes management solution by coupling our CGMS and our patch insulin pump via control algorithms.

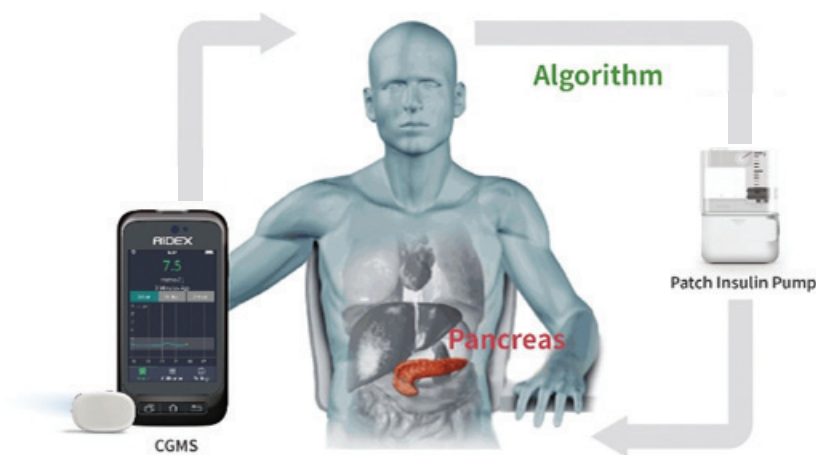

An artificial pancreas works in a similar way as the real human pancreas – it maintains a continuous, variable basal insulin delivery (which the delivery rate is higher when blood glucose is high, and delivery is less or even completely stopped when blood glucose is low). The control algorithm for an artificial pancreas is essentially a feedback loop, which functions to continuously collect blood glucose readings from the CGMS and insulin delivery history from the insulin pump, then calculate the residual insulin on board values and predict the change in the blood glucose. Based on such information and the glucose target range set by the user, it calculates how much insulin should be delivered in the next time window and send the command to the pump for execution.

Our artificial pancreas control algorithm utilizes a hybrid of the classical proportional-integral-derivative approach and the new model-based prediction control approach to provide best-in-class performance. Besides current and historical blood glucose values and insulin delivery history, our artificial pancreas is also designed to consider patient-specific parameters to fine-tune the output. It has gone through vigorous simulation testing and yielded satisfactory results. We are now developing the decision-making algorithm around the closed loop algorithm to ensure the safety of the system in even the most extreme circumstances.

BUSINESS



In addition, we plan to integrate cloud-based data analysis and AI technologies to our artificial pancreas, which will allow every user to enjoy a customized, safe and worry-free using experience.

Market Opportunity and Competition

Compared to existing diabetes management medical devices, the artificial pancreas device connects the treatment and monitoring functions of diabetes in a series, while the feedback regulation mechanism of a human pancreas is simulated by the closed loop control algorithm to realize the automation of treatment and monitoring, i.e., reducing high blood glucose levels (hyperglycemia) and minimizing the incidence of low blood glucose (hypoglycemia) with little to no input from the patient. The first artificial pancreas device in China is expected to be marketed by 2023. Based on its superior clinical advantages, the market size of the artificial pancreas device market in China is projected to reach US\$30.8 million in 2023 and approach to US\$488.4 million by 2030. The market size of the global pancreas device market increased from US\$522.4 million in 2017 to US\$1,053.9 million in 2020, at a CAGR of 26.4%, and is expected to further increase to US\$6,735.3 million, at a CAGR of 20.4% from 2020 to 2030.

According to the CIC Report, there was no artificial pancreas device marketed in China as of the Latest Practicable Date. The FDA had approved three artificial pancreas devices as of the Latest Practicable Date, which are set forth in the table below.

Major players in global artificial pancreas device market

Medtronic		Tandem		Dexcom	
					
Product	MiniMed 670G	MiniMed 770G	Product	Control-IQ hybrid closed loop	
FDA approved date	Sep-2016	Sep-2020	FDA approved date	Dec-2019	
Components	Calibration required CGMS + tubed pump	Calibration required CGMS + tubed pump	Components	Calibration-free CGMS + tubed pump	
FDA approved patient group	≥7 years old patients with Type 1 diabetes	≥2 years old patients with Type 1 diabetes	FDA approved patient group	≥6 years old patients with Type 1 diabetes	
Auto Mode	<input checked="" type="checkbox"/>	<input checked="" type="checkbox"/>	Auto Mode	<input checked="" type="checkbox"/>	
Basal Automation	<input checked="" type="checkbox"/>	<input checked="" type="checkbox"/>	Basal Automation	<input checked="" type="checkbox"/>	
Bolus Automation*	<input type="checkbox"/>	<input type="checkbox"/>	Bolus Automation*	<input checked="" type="checkbox"/>	

Note:

* MiniMed 770G will recommend a correction bolus, but need to manually accept.

Source: CIC Report

BUSINESS

According to the CIC Report, our artificial pancreas device is expected to become the world’s first closed loop solution that integrates the self-developed calibration-free CGMS and patch insulin pump system.

WE MAY NOT BE ABLE TO ULTIMATELY DEVELOP AND MARKET OUR ARTIFICIAL PANCREAS SUCCESSFULLY.

IVD Devices

BGMS Products

Blood glucose monitoring system, or BGMS, is a main type of diabetes monitoring medical device and has been used for years. BGMS usually collects blood drawn from the fingertip and uses disposable test strips to place into and reload the blood glucose meter so as to obtain single-shot blood glucose results. Test strips are supplied by the glucometer manufacturer and are generally device-specific. Since our inception, we have developed multiple types of blood glucose meters and test strips. As of the Latest Practicable Date, our BGMS products had received marketing approvals in major markets, including China, the U.S. and the EU.

Exactive Pro—Glucose, Ketone, Uric Acid Monitory System

We are leveraging our accumulated experience and know-how in BGMS products to develop Exactive Pro, which is designed to measure three parameters – blood glucose, ketone and uric acid – in one single device.



BUSINESS

Exactive Pro can achieve high accuracy and precision at wide hematocrit (or HCT, which measures the volume percentage of red blood cells) ranges (blood glucose: 20% to 70%; β -Ketone: 10% to 70%; uric acid: 10% to 70%). The following table sets forth key metrics of Exactive Pro:

	<u>Blood Glucose</u>	<u>β-Ketone</u>	<u>Uric acid</u>
Measurement range	10~600mg/dL	0.0~8.0mmol/L	150~1200 μ mol/L
Precision	\leq 100mg/dL, SD<7.7mg/dL; \geq 100mg/dL, CV<7.5%	<1.5mmol/L, SD<0.075mmol/L; \geq 1.5mmol/L, CV<7.5%	<380 μ mol/L, SD<42 μ mol/L; \geq 380 μ mol/L, CV<7.5%
Reaction time	5s	5s	10s
Sample size	Min. 0.5 μ L	Min. 0.8 μ L	Min. 1.0 μ L

We expect to commence the registrational clinical trial for Exactive Pro in the first half of 2021 and submit the registration application to NMPA in the second half of 2021. When approved, Exactive Pro is expected to be the first all-in-one product in China with all three parameters automatically code-free. As of the Latest Practicable Date, we were also exploring to equip Exactive Pro with Bluetooth connectivity. Users may receive data on smartphone app and get trends, statistics and other information for a more comprehensive monitoring. We position Exactive Pro as a multi-parameter device with high measuring accuracy for diabetes self-care and expect to market it through OTC and hospital channels in China and overseas.

WE MAY NOT BE ABLE TO ULTIMATELY DEVELOP AND MARKET EXACTIVE PRO SUCCESSFULLY.

IVocare Multifunctional POCT

HbA1C, MAU and hs-CRP+CRP are three key indicators in the monitoring and management of diabetes. We are developing a multifunctional POCT analyzer adaptable to three types of IVD assays used for the testing of HbA1C, MAU and hs-CRP+CRP.



BUSINESS

The following table sets forth key metrics of our multifunctional POCT:

	HbA1C	MAU	hs-CRP+CRP
Reaction time	4.0 minutes	3.5 minutes	3.5 minutes
Sample type	Whole blood	Urine	Whole blood/ serum/plasma
Sample size*	75μL	50μL	75μL
Storage temperature (°C)	4-30	4-30	4-30
Operating temperature (°C)	10-30	10-30	10-30
Shelf life	24 months	24 months	24 months

* including buffer mixture

Ivocare multifunctional POCT is exempted from clinical trial requirements in accordance with the Catalogue of Medical Device Exempted from Clinical Trials promulgated by the NMPA, as amended.

WE MAY NOT BE ABLE TO ULTIMATELY DEVELOP AND MARKET OUR IVOCARE MULTIFUNCTIONAL POCT SUCCESSFULLY.

RESEARCH AND DEVELOPMENT

We focus on developing innovative technologies and medical devices for the monitoring, treatment and management of diabetes. We believe that the success of our operations depends to a large extent on our ability to develop improved diabetes management medical devices. We have a proven track record of independently developing and commercializing diabetes management medical devices and management solutions.

We are engaged in ongoing R&D activities to deliver clinically advanced new products, to enhance the effectiveness, ease of use, safety, reliability, and to expand the applications of our products, as appropriate. We have a robust pipeline of product candidates in various stages of development, including our closed loop artificial pancreas, second-generation patch insulin pump system, AiDEX X and our IVD devices, which we anticipate to contribute to our future growth.

The time required from developing to commercializing a new product varies by product candidate and can be affected by various factors which may be beyond our control, such as clinical trial results and government policies and approvals. We incurred R&D expenses of RMB50.1 million and RMB82.0 million in 2019 and 2020, respectively.

Besides our diversified product portfolio, we have also developed a series of diabetes management solutions and we strive to build a cloud-based diabetes management platform to provide continuous, proactive and personalized diabetes management solutions worldwide.

BUSINESS

Cloud-based Diabetes Management Platform

To fully utilize the data collected or to be collected through our existing and future medical device products, we plan to build a cloud-based diabetes management platform for patients and healthcare providers. This cloud-based platform will organically integrate our products, after-sales services, and product and service updates that leverage big data and artificial intelligence technology. The cloud-based diabetes management platform is expected to support the post-marketing operation and feedback collection for further R&D of our Equil and other products. Through this cloud-based platform, we also plan to provide value-added services such as data analysis, disease management advising, and telemedicine for patients and healthcare providers.



R&D Team

We have a strong in-house R&D team of nearly 100 staff, including scholars and scientists from world-renowned universities, as well as elite engineers and seasoned experts. Our R&D team has outstanding interdisciplinary capabilities in the relevant fields, such as mechanical engineering, electrical engineering, software engineering, communication engineering and signal processing, electrochemistry, biomedical engineering and mathematics (algorithm) and artificial intelligence. Over 30% of our R&D staff possess a master or doctorate degree. Our key R&D staff have on average 13 years of relevant experience and more than dozen of our R&D staff has working experience at top medical device companies, such as Medtronic, Johnson and Johnson, Terumo, Flex (or known as Flextronics), among others.

Among our core R&D staff, Dr. Zheng Pan, our Chief Executive Officer, brings us nearly 20 years of industry leadership experience. Dr. Zheng Pan has led a competitive project under a National Major Scientific Research Program in 13th Five-Year Plan Period in 2016. Mr. Dore Chin Mark, our vice president for engineering has over 20 years of industry experience. Mr. Dore Chin Mark has successfully led the launch of a series of medical device products overseas, and he is the inventor of more than 10 issued patents and designs in the U.S. Dr. Yu

BUSINESS

Fei, our R&D director, is an outstanding scientist in the field of bioelectric chemistry. Dr. Yu Fei has accumulated years of experience in the R&D of diabetes management medical devices. Dr. Yu Fei is the inventor of more than 10 issued patents relating to the biosignal detection. Dr. Yu Fei is also the reviewer of five leading journals, including Biosensor & Bioelectronics, IEEE Sensor and PLOS One. Our core R&D staff have been with our Company since its inception and they are deeply committed to our mission. They have led the R&D of and brought to the global market multiple cutting-edge medical devices in their careers.

Externally, we have built long-standing relationship with industry KOLs, including well-known medical professionals and clinical experts. We leverage their meaningful insights and recommendations to steer our R&D process towards the unmet clinical needs. We have long-term collaborations with experts, universities and research institution in China. For example, we have jointly established the Flexible Electronics Joint R&D Center with Zhejiang University. To broaden our global research and development networks, we have also established a R&D center in Silicon Valley, which is expected to excel at tapping new centers of knowledge and enable us to commercialize products rapidly in the relevant local market.

In recognition of our strong R&D capability, we were designated as the Key Diabetes Research Center in Zhejiang Province, China. Equil was designated as an Innovative Medical Device Product by the PRC Ministry of Science and Technology. AiDEX G7 has been certified by the NMPA in May 2020 to be eligible for the Special Approval Procedures of Innovative Medical Devices promulgated by the NMPA. Our team focused on the R&D of an intelligent cognitive computed based closed loop artificial pancreas, was also awarded as “Leading Innovative Team” by the Science and Technology Department of Zhejiang Province.

Product Design

As of the Latest Practicable Date, we had established and strictly followed an internal protocol pursuant to NMPA regulations, ISO13485 standards and EU regulations on the quality management system of medical devices, including MDD 93/42/EEC and IVD 98/79/EEC and all related amended directives that govern the design and development of our products. The R&D team will join the sales and marketing team to conduct marketing survey and collect information required for and the feasibility of the product development. The R&D team will specify the product function, features, raw materials and manufacturing process in a written report and submit to our project management team and the senior management for approval. We set up our final design plan and product specifications through collaboration across teams. Each team undertakes work in the area of its expertise, which allows us to receive valuable input and guidance in each major aspect of product development. For each project, our project group members will collaborate with production technology team in determining the manufacturing methods, required machinery and manufacturing conditions. Our software development, electronic hardware, and mechanical structure teams are also involved in the optimization of project design. Our quality management team will assist with product testing with respect to its stability, reliability and other quality indicators under the design requirements. Our project management team takes lead in preparing documents and samples for registration inspection.

BUSINESS

We often collaborate with major hospitals, labs and universities in China and globally in the R&D of our products. We generally enter into agreements with these hospitals, labs and universities, the terms and conditions of which may vary from project to project and are determined on arm's length discussions.

Clinical Trials

Our clinical affairs team has significant experience in conducting clinical trials for our products. The team is responsible for clinical validation, including the preparation of clinical trial protocols and clinical trial reports. The leaders of our clinical affairs team have on average nearly 20 years of experience in the clinical trial registration and obtaining the overseas registration approval, and nearly 10 years of working experience at major multinational medical device companies.

We conduct clinical trials of our new products in order to obtain the requisite regulatory approvals and collect post-procedure data that can improve and enhance the design and features of our products. In addition, robust clinical data are an important marketing tool for our brand and products. The goal of a clinical trial is to measure the clinical efficacy and safety of a device. Primary parameters for clinical trials are selected based on the intended use of the medical device.

We have a separate regulatory affairs team that is in charge of regulatory communications. The team coordinates the evaluation of registration application, and submit our clinical report together with other materials to the relevant government agencies.

As of the Latest Practicable Date, we had initiated seven clinical trials, including six clinical trials in China. Our clinical data and practices are designed to meet applicable standards and regulatory guidelines.

Collaboration with Clinical Trial Institutions

The NMPA maintains a catalog of hospitals that it has approved as clinical trial centers, from which we select a number of leading hospitals with desirable expertise, patient samples, technology and equipment to conduct our clinical trials. We will meet with the selected participating hospitals to discuss the trial's goals and requirements, as well as to select the leading institution for the trial, which typically will be the largest and best-equipped hospital of the participating hospitals.

We typically enter into an agreement with each selected hospital for each clinical trial, under which we and the participating hospitals prepare a clinical trial protocol following GCP standards that describes in detail the goal of the clinical trial, the risks involved, the overall design, the methods and the procedures of the trial. We submit the relevant documents to the ethics committee of each participating hospital for review. Such documents typically include our clinical trial protocol, draft informed consent to be filled out by patients, draft case report forms to be completed by investigators supervising the clinical trial, and agreement with the

BUSINESS

hospital to perform the clinical trial. The ethics committees may ask us to revise the clinical trial protocol or other documents before their approval. Once the protocol is approved, any amendment thereafter is required to be reviewed and consented by the ethics committees and the clinical trials are required to be conducted strictly pursuant to the approved protocol.

Pursuant to the agreement, each participating hospital is obligated to conduct clinical trials following the protocol and at the end of the clinical trial, issues a case report based on the collected data. The leading institution gathers case report forms from all participating hospitals, and prepares formal reports of the clinical trial. We make payments according to the agreed schedules and items for the hospitals' services. In line with industry practice, under the agreement, we own all related intellectual property and results from the trial. Each participating hospital is entitled to publish academic papers or attend academic events using the trial results.

Relationships with CROs and SMOs

We use CROs and SMOs to manage, conduct and support our clinical trials. Our CROs provide services such as the implementation and management of clinical research projects as specified in the master agreement or a work order. Our SMOs provide services such as trial site management and subject enrollment support.

We select our CROs and SMOs based on various factors, such as their qualifications, academic credentials and professional experience of their employees and their industry reputations. We generally enter into an agreement regarding each clinical trial or research project with the CRO or SMO. We closely monitor our CROs and SMOs to help ensure their performance will comply with our protocols and applicable laws, regulations and guidelines, which in turn protect the integrity and authenticity of the data from our clinical trials and studies.

We have worked with CROs and SMOs for our clinical trials in China and overseas, including our clinical trials for Equil and AiDEX G7. Under the relevant agreements, we are responsible for the trial preparation, subject enrollment, trial implementation and management, and report preparation, while CROs and SMOs take responsibility for record keeping to ensure the compliance of clinical trial process with applicable laws, regulations and guidelines. We provide the CROs and SMOs with their required materials and information and make payments in accordance with the payment schedule agreed by parties. CROs and SMOs may further assist us in the trial preparation and management pursuant to our particular request, for which extra fees will be incurred. Under the agreements, we own all intellectual property and trial results. CROs and SMOs are obligated to keep all non-public information and data from the trials confidential, and return related materials to us at the end of our contract term.

BUSINESS

Other Collaboration

Collaboration with the Institute of Microelectronics and Nanoelectronics of Zhejiang University (“ZJU ISEE”)

In October 2016, we entered into a four-year collaboration agreement with ZJU ISEE (the “**ZJU ISEE Agreement**”), where we agreed to jointly establish a Flexible Electronics Joint R&D Center (the “**Joint R&D Center**”) to develop medical devices using flexible materials. Under the ZJU ISEE Agreement, ZJU ISEE agrees to provide access to its research sites, laboratories and equipment, and we will provide research funds to sponsor the Joint R&D Center’s R&D activities on a case-by-case basis.

Unless otherwise agreed by parties, with respect to projects fully sponsored by us, we will own the research achievements, including intellectual property rights and related economic interests, and ZJU ISEE will retain the right to use such research achievements solely for the purposes of research and development. With respect to projects mutually funded, both parties will share the research achievements in proportion to the funding amount of each.

The agreement can be terminated upon both parties’ mutual agreement, and parties can enter into separate agreements based on actual needs.

DATA PRIVACY AND PROTECTION

We currently operate substantially all our businesses in China. When conducting clinical trials for our products and providing services to our customers, we may have access to certain data of medical institutions and individual patients. Certain types of such data may fall into the scope of personal information under applicable laws and regulations. We have designed strict data protection policies to ensure that the collection, use, storage, transmission and dissemination of such data are in compliance with applicable laws and with prevalent industry practice.

As confirmed by our PRC Legal Advisor, we were not subject to any material claims, lawsuits, penalties or administrative actions which had a material and adverse effect on our business, financial condition or results of operations relating to non-compliance with applicable PRC laws and regulations with respect to data privacy and protection.

BUSINESS

MANUFACTURING

Our principal manufacturing facility is located at our headquarters in Hangzhou, China. As of the Latest Practicable Date, we owned manufacturing facilities with an aggregate area of approximately 15,000 sq.m., including a 1,500 sq.m. ISO Class 7 clean-room space and an 80 sq.m. ISO Class 8 clean-room space, for the production and pre-delivery inspection of our products. As of the Latest Practicable Date, our facility in Hangzhou was primarily used for the production of Equil and BGMS products.

The following table sets forth the production capacity, actual production volume and utilization rate of our manufacturing facility in Hangzhou for the years indicated:

Products	For the year ended December 31,	
	2019	2020
	<i>(in thousand, except for percentages)</i>	
Equil – Patch pump and PDA		
Production capacity (units) ⁽¹⁾	5.6	7.0
Actual production volume (units)	4.1	5.6
Utilization rate (%) ⁽²⁾	72.9	79.5
Equil – Disposables		
Production capacity (units) ⁽¹⁾	385.3	795.3
Actual production volume (units)	305.3	778.9
Utilization rate (%) ⁽²⁾	79.2	97.9
Blood glucose meters		
Production capacity (units) ⁽¹⁾	461.5	720.4
Actual production volume (units)	334.3	659.5
Utilization rate (%) ⁽²⁾	72.4	91.5
Test strips		
Production capacity (units) ⁽¹⁾	64,441.6	101,911.7
Actual production volume (units)	51,738.5	85,480.6
Utilization rate (%) ⁽²⁾	80.3	83.9

Notes:

- (1) Production capacity is computed based on 235 effective production hours per month.
 (2) Utilization rate equals actual production volume divided by production capacity.

BUSINESS

Our patch insulin pump system is mainly composed of the PDA, the pump and disposables (the insulin reservoir and cannula). The manufacturing of these components primarily involves the following steps:

(A) Portable diabetes assistant

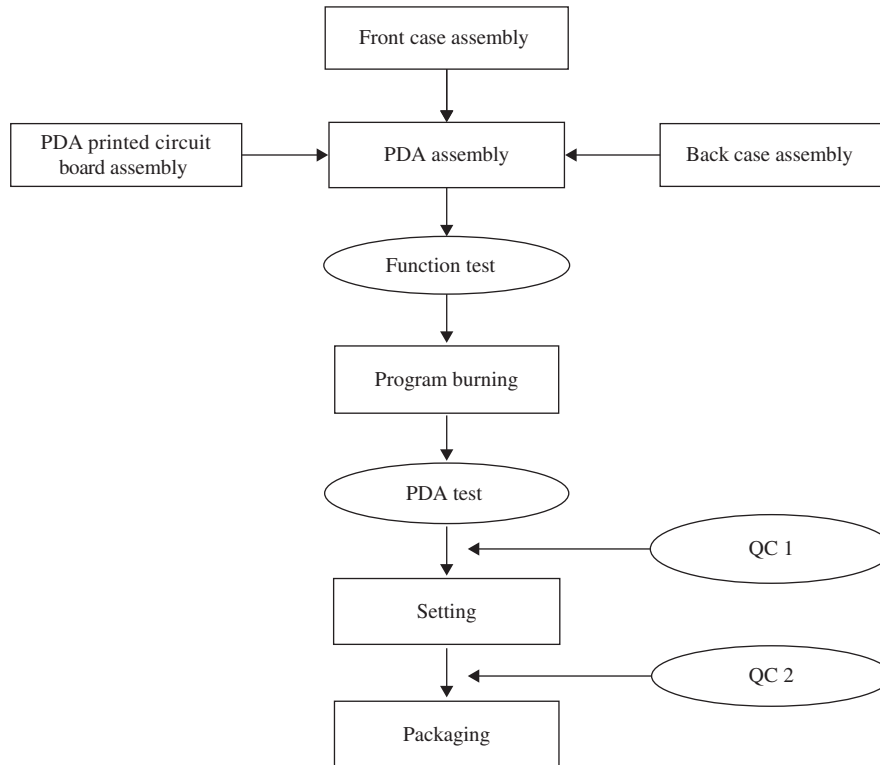

(B) Patch pump

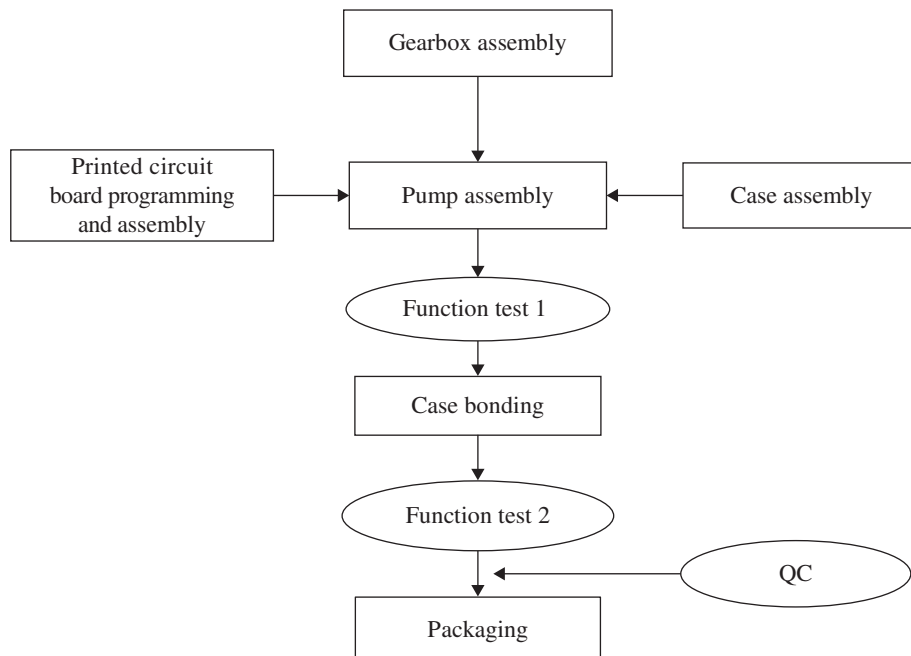

BUSINESS

(C) Disposables

Insulin reservoir

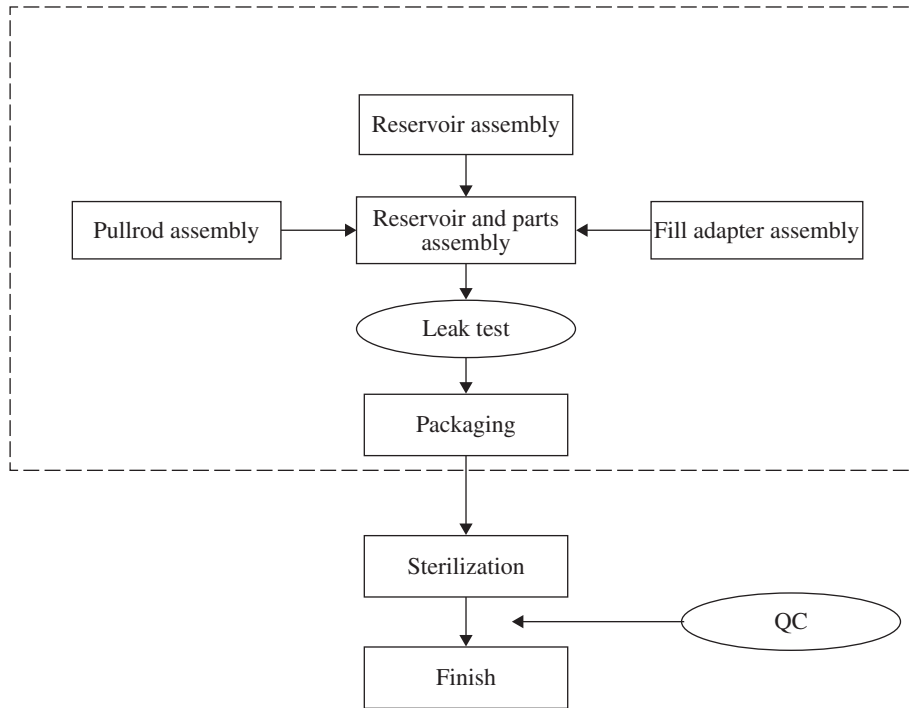

Cannula

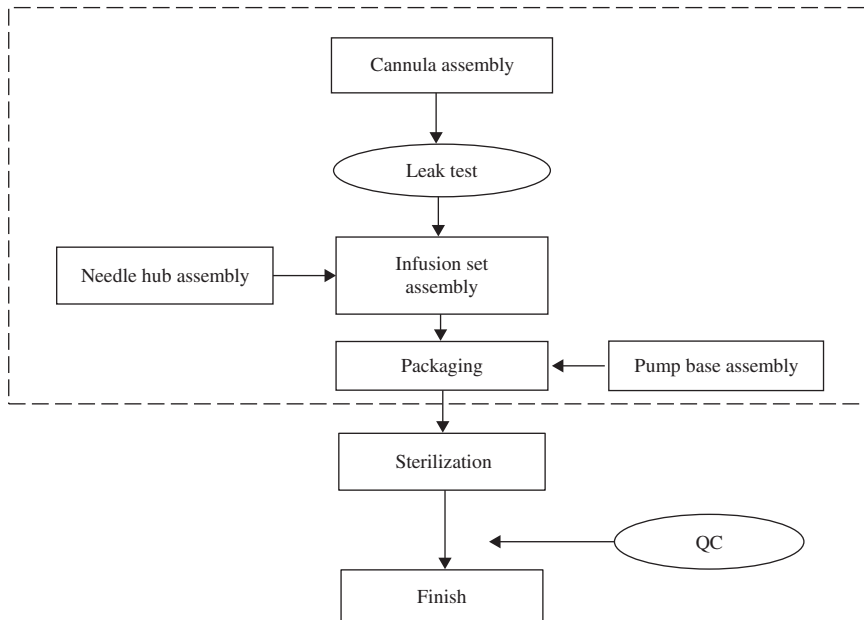

BUSINESS

The manufacturing of our blood glucose meters primarily involves the following steps:

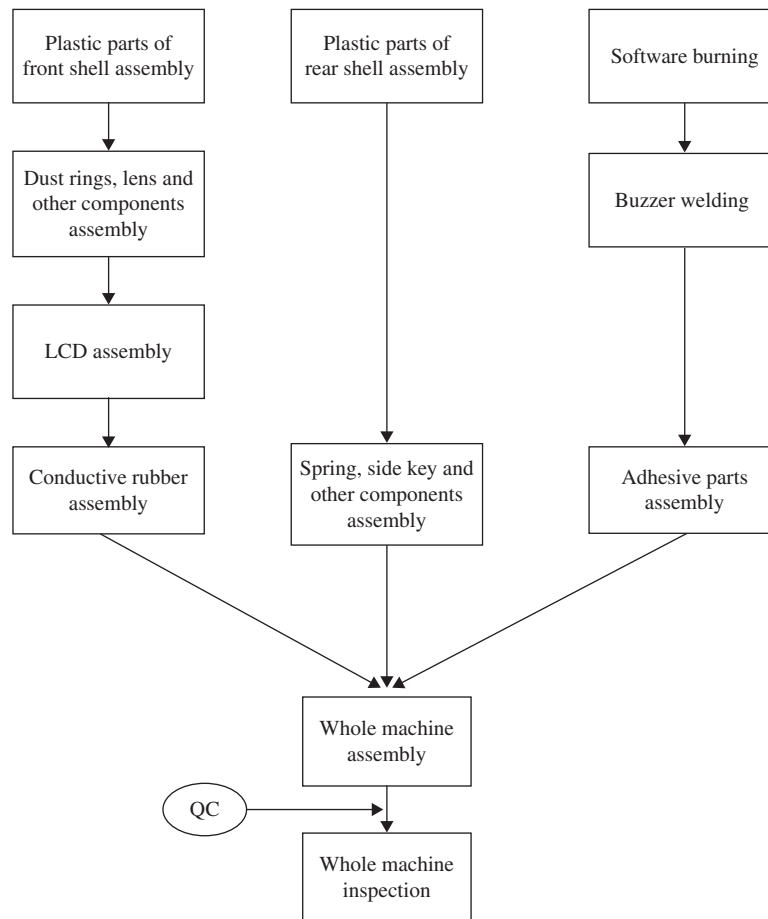

The steps within the dotted line above are conducted in a controlled clean environment (ISO Class 7 or 8), and the other steps are conducted in regular environment. We have implemented quality management systems as part of our manufacturing processes. See “—Quality Control.”

We conduct all the key manufacturing process of our products in-house. The head of our manufacturing team in China has extensive manufacturing experience in the medical devices industry. Our integrated production process increases our production efficiency, reduces our dependence on third parties, and enables us to adjust our production in a timely fashion to respond to changes in market demand for our products.

We have entered into agreements with an Independent Third Party to delegate the patch of printed circuit boards, tape die-cutting and sterilization of finished products. We are able to monitor and control the standard and quality of these delegated work through our agreements with third parties. The delegated party is obligated to conduct these manufacturing procedures as required by the standard stipulated in the quality assurance agreements. We retain the right to inspect the delegated party’s facility and equipment, evaluate whether it adheres to the required standards and request the delegated party to improve accordingly. Also, the delegated party’s work is subject to our examination, and we retain the right to return the product for further sterilization. To help ensure a consistent standard of these procedures, we tend to delegate each type of work to one primary entity.

BUSINESS

We primarily use various types of customized automatic production lines, assembly equipment, dispensers, laser cut machines and print machines to manufacture our products. We purchase machinery from multiple suppliers, and we are able to purchase such machinery from alternative suppliers. We have implemented a comprehensive inspection and maintenance system for our machinery. We have also put in place measures and plans for emergency maintenance. During the Track Record Period, we had not experienced any significant or prolonged interruptions of our machinery due to equipment or machinery failure.

We believe that our location gives us an advantage in manufacturing over our international competitors. We have access to China's vast labor pool and enjoys various governmental supports to attract high-caliber talents, which makes it easier for us to hire people with the appropriate skills for our production. We typically require new employees to undergo a strict training and pass our evaluation before they commence work on our production lines. The training continues with respect to specific steps in the production process after employees commence work on the production lines. The comprehensive training yields high-quality production and enables us to enhance our manufacturing efficiency.

SALES AND MARKETING

We use a combination of our in-house sales and marketing team and a network of independent distributors to sell our products in China and globally. As of the Latest Practicable Date, we had a sales and marketing team of 123 members, and our core sales personnel had on average more than 15 years of experience working in the relevant field with us.

Our in-house sales and marketing team tracks and analyzes applicable local laws and regulations and government policies as well as market data of our products in order to formulate regional and overall marketing strategies effectively.

Our Marketing Model

Our marketing strategy focuses on building awareness for the benefits of our products and generating demand and acceptance of our products among healthcare professionals and patients through our user-centric and clinical-data-driven promotion.

Our highly trained sales and marketing team focuses on interacting with physicians and patients to educate them about, and train them in the use of, our products. Such interaction is fostered through regular visits and communications, on-site demonstration of our products, training and education programs. For example, we are able to educate and train physicians in respect of CSII therapy, and present the innovative features of Equil that make it well-positioned to satisfy the clinical need in CSII therapy. Although patients are the end users of our products, physicians, procurement departments of hospitals and other medical institutions decide what products to stock and physicians typically recommend to patients what products to use. Based on our experience, as physicians become more knowledgeable and experienced with our products, they will be more likely to recommend our products. In addition to

BUSINESS

accelerating market awareness and adoption of our products, our communications with these physicians also provide us with continual feedback on our products and trends in the market which helps guide our R&D projects.

We also regularly organize and attend educational symposia, conferences, seminars, and other activities at national, regional and local levels. For example, we have sponsored and attended conferences that gathered leading international experts focused on therapeutic areas of diabetes and other chronic diseases, including the 17th International Congress of Immunology of Diabetes Society, China Diabetes Society Annual Meetings, and Endocrinology Society of China Annual Meetings. Because of our advanced technology and our first-mover experience, our products have been among the central topics of academic discussions and examples for training, and our R&D experts and management have been invited as speakers to introduce their practices in this field. These seminars and conferences allow us to introduce our products, share our clinical results and enhance experts’ awareness of clinical benefits of our products.

In addition, we leverage our network with KOLs and depend on KOLs to introduce and recommend our products to physicians and hospitals. KOLs have academic incentives in learning the latest disease treatment options available within their therapeutic areas, as well as introducing cutting-edge technologies and products that they believe have clinical benefits to other medical professionals. We provide these experts with detailed information of our products and help them make independent comparisons among competing products in the market. We believe that these KOLs’ independent views on our products help increase the market recognition of our products among the wider medical community across the country. All of our KOLs are Independent Third Parties. When selecting KOLs for a specific academic event, we consider factors such as the participating doctor’s vocational affiliation, the purpose and scale (local, regional or national) of the event, as well as the KOL candidate’s academic and professional backgrounds, medical specialties and reputation in the industry. We also consider whether they have participated in clinical studies or published academic articles related to related products. We usually choose physicians who have used our products before as KOLs. We typically enter into agreement with the KOLs for their services in giving presentations in academic conferences and on-site training, coaching and proctoring physicians in hospitals, and we make payment to the KOLs accordingly.

Besides our primary academic marketing model, we also rely on our distributors to promote and market our products. Each of our distributors has its own sales force that focuses on marketing in its particular territory and assigned hospitals. Distributors have engaged in promoting our products through their network of hospitals and physicians. For details, see “—Our Sales Arrangements—Sales through distributors.”

BUSINESS

Our Sales Arrangements

In line with the industry practice in the medical devices industry, we sell substantially all of our products to distributors, who are our customers, and they resell our products to hospitals, pharmacies or individual customers. Our in-house sales and marketing team primarily focus on enhancing professionals’ knowledge and understanding of the usage, clinical effects and advantages of our products. We believe this distribution model helps extend our coverage in a cost-effective manner while retaining proper control over our distribution network and marketing and promotion process.

We set annual and monthly/quarterly sales targets of our products at the beginning of each year and each quarter. We assess information our marketing personnel gathers from hospitals and other customers and adjust our sales forecasts accordingly on a monthly basis. We also refer to the historical numbers of purchases for our sales projections. We believe that the information provided by our sales and marketing team allows us to estimate market demand for our products.

Since the fourth quarter of 2019, we launched a pilot program for the marketing and promotion of Equil. In the pilot program, we sell Equil to our distributors, who, may allow patients that are recommended or required to receive short-term intensive insulin therapy with insulin pump to rent Equil for a specified period a time. Under this model, distributors are the ultimate owners of the purchased product.

The following table sets forth a breakdown of our revenue generated from distributors and direct sales for the years indicated:

	For the year ended December 31,			
	2019		2020	
	<i>RMB’000</i>	<i>%</i>	<i>RMB’000</i>	<i>%</i>
Sales to distributors	51,251	98.8	73,277	97.3
Direct sales	612	1.2	2,000	2.7
Total	51,863	100.0	75,277	100.0

Sales through distributors

- *Selection of distributors*

Our sales and marketing team screens and selects distributors whom we believe have the required qualifications and capabilities and are suited to our strategic marketing model, and establishes and maintains resource sharing with our distributors to effectively execute our marketing strategies specifically tailored to each geographic location and the hospitals located within their locations.

BUSINESS

Upon selecting distributors, we will first evaluate their qualifications. Our distributors primarily engage in the medical device distribution business. We select our distributors based on their experience in the medical devices industry, particularly in diabetes devices. In addition, they must possess the requisite business licenses and permits to sell medical devices in the respective jurisdiction and have established relationships with hospitals and physicians within their designated territory. Before we appoint a distributor, we assess its sales staff and management to help ensure that they have the appropriate educational background and professional skills. We also consult with the hospitals regarding our choice of distributors and consider any recommendation from the hospitals. We review the qualifications of our distributors when our contracts with them are due to be renewed. During the Track Record Period, none of our distributors had any past or present relationship (business or otherwise) with our Group, our Shareholders, Directors, Supervisors, senior management or any of their respective associates.

- *Rights and obligations relating to the sales of our products*

We do not allow overlap of distributors among hospitals. Distribution relationships between our distributors and the respective hospitals are exclusive. In the event that our distributors engage sub-distributors to sell our products, such sub-distributors will also be required to enter into distributorship agreement with us and abide by our policies and regulations. The amount of the products we sell to a distributor depends on the number of sales generated from hospital, pharmacies and individual customers in the designated area. We recognize revenue from distributor sales when control of goods or services is transferred to the customers.

We generally store our products in warehouses and deliver our products directly to distributors. Our distributors are responsible for collecting payments from their customers, and are required to pay us for the products regardless of whether they receive payments from their customers.

We enter into agreements with our distributors that specify terms including their designated distribution area and hospitals, target order amount and credit terms. The principal terms are summarized below.

Duration	The distribution agreements typically have a term of one year.
Designated geographical regions	The geographical regions for which a distributor is responsible are designated. A distributor is prohibited from selling our products outside its designated geographical regions without our prior consent. We may request a distributor to make a deposit to guarantee its distributions within the designated geographical regions.

BUSINESS

Target order amount	An annual target order amount is set and further scheduled by month or by quarter. We are entitled to terminate the distribution if the distributor fails to achieve 50% of the target order amount during the term of the distribution agreement.
Transportation	The distributor may elect to (i) pick the products, arrange for and bear the costs and risk of loss of the transportation; or (ii) request us to transport products and bear the costs and risk of loss of the transportation, while we will not bear the costs of transportation if the distributor fails to meet a stipulated purchase amount.
Product returns	<p>In general, the distributor may not return products to us or exchange products other than for product quality issues and any such request shall be made with a stipulated period of time upon receipt of our products.</p> <p>We will bear the costs of transportation for returning the defective product if quality issues are confirmed after inspection.</p>
Warranty	We provide a four-year warranty on our patch insulin pump and a ten-year warranty on our blood glucose meters.
Termination	The agreement may be terminated by us when, among other things, the distributor breaches pricing provision or fails to meet 50% of the target order amount. The distributor can terminate when we fail to correct our breach of contract within a stipulated period of time after receiving their notice of correction.
Regulatory compliance	The distributor is required to comply with all applicable laws and regulations, including, among other things, anti-bribery and anti-kickback laws and regulations. The distributor is also required to obtain relevant permits to sell and distribute medical devices and maintain storage facilities compliant with regulatory standards on medical device storage, and provide us with copies of the relevant licenses, permits and certificates.

BUSINESS

We conduct annual review of our distributors, based on their financial performance, business performance and regulatory compliance. Distributors’ financial performance is primarily evaluated by their credit records with us during each period, and the evaluation of their business performance is primarily based on the distributors’ sales performance, specifically whether they meet the target order amount, and the designated hospitals’ feedbacks. We also review their compliance with applicable laws and regulations. We retain the discretion to adjust their credit terms, renegotiate order price and certain other commercial terms with them based on the review results. Our sales and marketing department monitors, manages and supports the activities of our distributors to help ensure that they comply with our guidelines, policies and procedures.

According to our trading terms with customers, prepayment is normally required, except for certain customers, where credit period is allowed, and the credit period is generally within three months. During the Track Record Period, our distributors did not materially breach our contract terms, and we did not have any disputes with our distributors relating to the settlement of trade receivables. As of the Latest Practicable Date, we were not aware of any potential abuse or improper use of our name by our distributors which could adversely affect our reputation, business operation or financial condition.

- *Relationship with distributors*

As of December 31, 2019 and 2020, we had a total of 271 and 370 distributors for the sales of our products, respectively. The following table sets forth the changes in the number of our distributors for the years indicated:

	For the year ended December 31,	
	2019	2020
As of the beginning of the period	227	271
Additions of new distributors	147	167
Termination of existing distributors	103*	68
Net increase in distributors	44	99
As of the end of period	271	370

Note:

* We terminated our agreements with a significant number of distributors in 2019, as we enhanced the qualification and capability requirements for our distributors during the screening and selection process to further optimize our distribution network.

BUSINESS

Direct sales

In addition to the sales through our distributors, we sell a small portion of our products directly to large pharmacies and individual customers. During the Track Record Period, we did not have any disputes with the large pharmacies and individual customers relating to the settlement of trade receivables.

Pricing

During the Track Record Period, we primarily sell our products to our distributors. Our domestic distributors negotiate and set retail prices directly with hospitals, and such retail prices shall not be less than the suggested resale prices set in the distributorship agreement without our prior consent. We also conduct regular checks on their compliance to our pricing requirements. The retail price of our products sold by our overseas distributors may vary from country to country, subject to factors such as prices of competing products and local insurance coverage. For our direct sales to customers, we negotiate the price directly with relevant customer.

CUSTOMERS

During the Track Record Period, we derived substantially all of our revenue from the sales of Equil and BGMS products.

For the years ended December 31, 2019 and 2020, all of our five largest customers were distributors and the aggregate sales to our five largest customers were RMB6.8 million and RMB11.2 million, representing 13.2% and 14.9% of our revenue, respectively. Sales to our

BUSINESS

largest customer for the same periods were RMB1.6 million and RMB3.1 million, representing 3.1% and 4.1% of our revenue, respectively. The following is a summary of the sales to our five largest customers for the periods indicated:

Five Largest Customers

for the Year Ended December 31, 2019

	Company Background	Sales Amount	Percentage of Revenue
		<i>RMB'000</i>	
Customer A	A private company that engages in the sales of Class II and III medical devices	1,621	3.1%
Customer B	A company that engages in the sales of Class II and III medical devices	1,380	2.7%
Customer C	A private company that engages in the sales of Class II and III medical devices	1,311	2.5%
Customer D	A private company that engages in the sales of Class I, II and III medical devices	1,283	2.5%
Customer E	A foreign company that engages in the sales of medical devices	1,224	2.4%
		6,819	13.2%
Total		6,819	13.2%

BUSINESS

Five Largest

Customers

for the Year Ended

December 31, 2020

	Company Background	Sales Amount	Percentage of Revenue
		<i>RMB'000</i>	
Customer D	A private company that engages in the sales of Class I, II and III medical devices	3,106	4.1%
Customer F	A private company that engages in the sales of Class I and II medical devices	2,638	3.5%
Customer G	A foreign company that engages in the sales of medical devices	2,123	2.8%
Customer H	A foreign company that engages in the sales of medical devices	1,690	2.3%
Customer I	A private company that engages in the sales of Class II and III medical devices	1,659	2.2%
Total		11,216	14.9%

All of our five largest customers during the Track Record Period are Independent Third Parties. During the Track Record Period, none of our Directors or any Shareholders, who, to the knowledge of our Directors, owns more than 5% of our issued share capital immediately following the completion of the [REDACTED] (but without taking into account the exercise of the [REDACTED]) nor any of their respective associates had any interest in any of our five largest customers.

BUSINESS

CUSTOMER SERVICE

Given the chronic nature of diabetes, we believe that thorough training and ongoing customer support are important to develop a long-term relationship with hospitals and end users. We provide the following reliable, effective and satisfactory customer services, which contributes to the improvement of user experience and product satisfaction.

- *Comprehensive training support.* We are dedicated to providing comprehensive support to assist physicians and other healthcare professionals in training patients receiving CSII therapy regarding the use of our products. Besides regular on-site visits, we collaborate with China Nursing Association to provide clinical processes and guidelines to certify nurses through Certified Trainer Program. In addition, we have established a network of certified pump trainers (“CPTs”), consisting of our in-house and our distributors’ customer service staff. We provide our CPTs with a training kit, including relevant methodology and documentations, as a guide for them to train patients on the effective use of our products.
- *24/7 customer support.* We provide 24/7 customer support to provide training to healthcare professionals and users of our products and handle all kinds of customer queries and complaints regarding our products and services. They are able to seek technical supports, make queries and file complaints on the quality of our products and adverse events after use via various channels, such as phone calls, online written instant messaging, and face-to-face communications. We had not received any major customer complaints during the Track Record Period and up to the Latest Practicable Date.
- *Severe adverse event reporting and product recalls.* We have an operations team dedicated to tracking and recording severe adverse events. If the team determines that an incident involving our product constitutes a major adverse event under NMPA regulations, we will report the incident to the NMPA and assess the cause for the adverse events. Our operations team also investigates and analyzes the cause of issue raised by our customers and refers the quality issue to our management and relevant responsible departments for resolution and correction. We will recall our products for quality issues when necessary. During the Track Record Period and up to the Latest Practicable Date, there had not been any product recalls due to quality issues.

BUSINESS

RAW MATERIALS AND SUPPLIERS

Suppliers

For the years ended December 31, 2019 and 2020, purchases from our five largest suppliers in aggregate accounted for 33.7% and 19.3% of our total purchases (including value added tax), respectively, and purchases from our largest supplier accounted for 19.4% and 5.8% of our total purchases for the same periods (including value added tax), respectively. During the Track Record Period, our purchases mainly include raw materials, softwares, equipment and services from third parties. The following is a summary of the purchases from our five largest suppliers for the periods indicated:

Five Largest Suppliers for the Year Ended December 31, 2019	Purchases	Purchase Amount	Percentage of Total Purchase
		<i>RMB'000</i>	
Supplier A	Infrastructure engineering service	15,901	19.4%
Supplier B	GMP installment	5,840	7.1%
Supplier C	Plastic materials	2,129	2.6%
Supplier D	Technology R&D and Software	1,947	2.4%
Supplier E	Electronic materials	1,831	2.2%
Total		27,648	33.7%
		<i>RMB'000</i>	
Five Largest Suppliers for the Year Ended December 31, 2020	Purchases	Purchase Amount	Percentage of Total Purchase
		<i>RMB'000</i>	
Supplier F	Infrastructure engineering service	5,780	5.8%
Supplier E	Decoration service	4,303	4.3%
Supplier G	Plastic materials	3,454	3.5%
Supplier H	Electronic materials	3,134	3.2%
Supplier I	Circuit boards	2,470	2.5%
Total		19,141	19.3%

BUSINESS

All of our five largest suppliers during the Track Record Period are Independent Third Parties. During the Track Record Period, none of our Directors or any Shareholder who, to the knowledge of our Directors, owns more than 5% of our issued share capital immediately following completion of the [REDACTED] (but without taking into account the exercise of the [REDACTED]) nor any of their respective associates had any interest in any of our five largest suppliers.

Raw Materials

For the production of our diabetes products and product candidates, our principal raw materials are printed circuit boards, wafer parts, motors and LCD panels, and other raw materials include packaging materials and plastic parts. The raw materials we sourced from our suppliers are generally readily available in the market through many suppliers. We believe we have alternative sources for our principal raw materials with comparable quality and prices. We have not experienced any significant difficulties in maintaining reliable sources of supplies and expect to be able to maintain adequate source of quality supplies in the future. As of the Latest Practicable Date, our principal raw material suppliers were based in China, from whom we purchased raw materials on an as-needed basis.

We generally enter into supply agreements and maintain long-term relationships with our principal raw material suppliers. Our agreement with suppliers typically lists our quality requirements. For some principal raw materials, we also enter into a separate quality assurance agreement with the relevant suppliers. We will decide whether to accept the supply upon inspecting and examining the materials. We make prepayments to some of our suppliers for raw materials, and our other suppliers for raw materials usually provide us with a credit term of up to 30 days.

INVENTORY

Our inventories consist of raw materials, work in progress and finished goods. We have established inventory policies, management procedures and provide adequate training sessions on inventory management. Our procurement department manages our inventory levels by monitoring in real time our production activities and sales orders and also taking into consideration any emerging trends through discussions with our sales and marketing department. Based on effective sales orders and forecast information, the planning department develops a production and inventory plan, which is updated on a monthly basis, and places orders with suppliers for any inventory which is expected to decline below targeted levels.

We generally maintain an inventory level of one- to two-month sales volume for our finished goods and four-to-eight-week supply of our raw materials, and such level will vary according to the demand of our customers, sales and production plans. We store substantially all our inventories in our headquarters in Hangzhou, Zhejiang Province, China.

BUSINESS

Our raw materials are typically not subject to expiration. We have set up the safety stock of our principal raw materials and we will receive alarms through enterprise resource planning ("ERP") system if there is any shortage.

Our products are typically sold on a first-in-first-out basis. To minimize the risk of inventory backlogs, we conduct monthly, quarterly and annual reviews of our inventory levels. We also carry out physical stock counts and stock inspections from time to time to identify damaged products or obsolete products, which are disposed of or for which provisions are made.

During the Track Record Period, we did not experience any material shortage of inventory.

QUALITY CONTROL

We have a quality management department that devotes significant resources to quality management of our products. We have our own quality control system and devote significant attention to quality control for the designing, R&D manufacturing, testing and transportation of our products and product candidates. Our management team is actively involved in setting quality policies and managing our internal and external quality performance. We have established a strict quality control system in accordance with NMPA regulations, ISO13485 standards and EU regulations on the quality management system of medical devices, including MDD 93/42/EEC and IVD 98/79/EEC and related amended directives.

As of the Latest Practicable Date, our quality management department consisted of 25 employees. The department is divided into a quality system team, product quality team and R&D quality team. Our quality system team is responsible for setting up quality management system in compliance with applicable regulations and industry standards and also in charge of post-market surveillance for the global sales of our products. Our product quality team is further divided into a quality control team and quality assurance team. The quality control team is responsible for inspecting raw materials, production process and the quality of finished goods, while quality assurance team focuses on the implementation and maintenance of our quality management system, as well as monitoring our operation in real time throughout the entire production process to ensure its compliance with our quality management system. Our R&D quality team is responsible for the implementation of our quality management system throughout the R&D process and make sure the product and process under development is compliant with application regulations and industry standards.

BUSINESS

Quality Control of Raw Material Supply

Prior to entering into supply agreements with our raw material suppliers, we perform background checks on the operating history, track record and market reputation of a list of potential suppliers, procure different product samples from the potential suppliers for inspection, if needed, and testing by our quality management department, conduct site visits and examine the production facilities of the potential suppliers to help ensure that the suppliers that we select meet our quality requirements, if applicable.

For our principal raw materials, suppliers are obligated to take measures to comply with our quality control standards for their products and production process. We are entitled to conduct on-site audits at the suppliers’ premises to monitor their compliance with agreed quality assurance actions, which may be effected in the form of system, process or product audits. We also conduct off-site information assessments to evaluate the suppliers’ performance. Traceability of the raw material supplies is required for our principal suppliers. Upon receiving supplies, we retain the right to reject or return based on our inspection and examination results.

Quality Control of Inventory

Our quality management department and our warehouse personnel take responsibilities and collaborate to help ensure the quality of our raw materials and products inventory. The quality management department is in charge of inspecting and examining raw materials and products before they are accepted as inventory.

The warehouse personnel is responsible for recording the inventory to ensure the traceability of our raw materials and products, the regular storage, maintenance and inspection of the inventory and warehouse maintenance. Designated warehouse personnel inspect the inventory on a regular basis according to the required storage and maintenance conditions of relevant inventory.

Quality Control of Design and Development

All the procedures of our design and development activities must strictly follow our design and development control policy and procedures, which specifically lists the stages to develop a new product. As discussed in the section headed “—Research and Development—Product Design” above, the project team for each project consists of representatives from various departments who contribute to our R&D work in their respective expertise fields. At the same time, the project team strictly follows each step of our internal protocol, and the design and development committee closely monitors and reviews key stages along the design and development process.

BUSINESS

Quality Control for Manufacturing

Our quality management department is responsible for ensuring that we comply with applicable regulatory and industry standards throughout the entire manufacturing process through regular on-site inspections. After completing each step of the production process, we perform cleaning and maintenance procedures to prevent contamination or cross contamination before we proceed to the next production cycle. In addition, we perform regular dust and microbiological testing in our production facilities in accordance with our detailed manufacturing standards.

Each batch of our products is subject to a strict sample inspection before sales. We conduct sample testing on certain work in progress and semi-finished products at particular stages of production. In addition, our quality control team inspects the documentation relating to product quality, including its batch records, laboratory control records, production process records and other information that may impact product quality. Thereafter, they conduct a final review on all documents and determine whether a specific product can be released for shipment. Products that do not meet our quality standards are destroyed or otherwise disposed of in accordance with the relevant environmental control requirements.

After-Sale Quality Control

We are able to track our products sold to our end customers. We analyze feedback from our distributors and hospitals and handle any customer complaints with respect to the quality of our products. Quality complaints, both verbal and written, are documented and investigated pursuant to standard procedures. We have dedicated employees responsible for responding to complaint calls.

If any product falls short of the relevant quality standards, we will replace the defective product at our own costs. During the Track Record Period and up to the Latest Practicable Date, we did not experience any product returns or product liability claims.

INTELLECTUAL PROPERTY RIGHTS

Intellectual property rights are important to our business. Our future commercial success depends, in part, on our ability to obtain and maintain patents and other intellectual property and proprietary protections for commercially important technologies, inventions and know-how related to our business, defend and enforce our patents, preserve the confidentiality of our trade secrets, and operate without infringing, misappropriating or otherwise violating the valid, enforceable intellectual property rights of third parties.

As of the Latest Practicable Date, we owned 59 issued patents and pending patent applications. We had 17 issued patents and 26 pending patent applications in China. We also had one issued overseas patent, seven overseas patent applications and eight international patent applications under the PCT.

BUSINESS

We acquire patents through self-development. As of the Latest Practicable Date, we self-owned all of our patents as well as patent applications and had no co-own or co-share arrangements of our patents and patent applications with third parties.

The table below lists the portfolio of material patents and patent applications of which we are the registered owner by product as of the Latest Practicable Date:

Product	Name of Patent	Components	In-review/Approval Number	Expiration Date	Covered Region	Status
Equil Patch Insulin Pump System	A wireless communication system for patch insulin pump systems	Wireless communication system	201210104999.5	April 10, 2032	China	Granted
	A connection mechanism for connecting a patch insulin pump and a base plate	Shell structure	201210111391.5	April 15, 2032	China	Granted
	A structure for connecting a patch insulin pump and a drug reservoir	Shell structure	201210180697.6	June 3, 2032	China	Granted
	An individualized insulin pump configuration optimization system based on cloud-based big data	Closed loop system	201710947229.X	October 11, 2037	China	Granted
	A method for controlling the infusion of insulin pump	Infusion set	202010093449.2	February 13, 2040 (if granted)	China	Pending
	Needle aids and medical systems including needle aids	Needle aids and medical system	PCT/CN2020/116839	–	Pending PCT national phase entry	Pending
	A method for controlling the infusion of insulin pump	Controlling method	PCT/CN2020/135161	–	Pending PCT national phase entry	Pending
AiDEX CGMS	A preparation method of electrochemical sensor with surface-cured polypeptide probe	Sensor	201610756537.X	August 28, 2036	China	Granted
	An electrochemical analyte sensing system and method capable of self-correcting interference signals	Sensing system	201610792337.X	August 30, 2036	China	Granted

BUSINESS

<u>Product</u>	<u>Name of Patent</u>	<u>Components</u>	<u>In-review/Approval Number</u>	<u>Expiration Date</u>	<u>Covered Region</u>	<u>Status</u>
	An intelligent real-time dynamic blood glucose monitoring system and method based on cloud-based big data	Monitoring system	201710947227.0	October 11, 2037	China	Granted
	Needle aids and medical systems including needle aids	Needle aids	201911071063.5	November 4, 2039 (if granted)	China	Pending
	Triblock copolymers for implantable biosensor and their application and preparation method	Sensor	202010192423.3	March 18, 2040 (if granted)	China	Pending
	A glucose electrochemical sensor and its preparation method	Sensor	202010832447.0	August 17, 2040 (if granted)	China	Pending
	Biosensing systems having biosensors coated with co-polymers and their uses thereof	Sensing system	WOCN19085200	–	the European Union, Canada, Germany, Spain	Pending
	Biosensors coated with co-polymers and their uses thereof	Sensor	WOCN19085198	–	Canada, the European Union	Pending
	Implantable monitoring device calibration methods, sensor components and blood glucose monitoring systems	Calibration method, sensor and monitoring system	PCT/CN2020/130643	–	Pending PCT national phase entry	Pending
	Triblock copolymers for implantable biosensor and their application and preparation method	Sensor	PCT/CN2020/135162	–	Pending PCT national phase entry	Pending
	Cloud big data-based smart real time dynamic blood sugar monitoring system and method	Monitoring system	EP18867137	–	Europe	Pending

The term of an individual patent may vary based on the countries/regions in which it is granted. In China and most other countries and regions in which we file patent applications, the term of an issued patent for invention is generally 20 years from the filing date of the earliest non-provisional patent application on which the patent is based in the applicable country. The actual protection afforded by a patent varies on a claim-by-claim and country-by-country basis and depends upon many factors, including the type of patent, the scope of its coverage, the availability of any patent term extension or adjustment, the

BUSINESS

availability of legal remedies in a particular country/region and the validity and enforceability of the patent. We cannot provide any assurance that patents will issue with respect to any of our owned or licensed pending patent applications or any such patent applications that may be filed in the future, nor can we provide any assurance that any of our owned or licensed issued patents or any such patents that may be issued in the future will be commercially useful in protecting our product candidates and methods of manufacturing the same.

We may rely, in some circumstances, on trade secrets and/or confidential information to protect aspects of our technology. We seek to protect our proprietary technology and processes, in part, by entering into confidentiality agreements with consultants, scientific advisers and contractors. We have entered into confidentiality agreements and non-competition agreements with our senior management and certain key members of our R&D team and other employees who have access to trade secrets or confidential information about our business. Our standard employment contract, which we use to employ our employees, contains an assignment clause, under which we own all the rights to all inventions, technology, know-how and trade secrets derived during the course of such employee’s work.

These agreements may not provide sufficient protection of our trade secret and/or confidential information. These agreements may also be breached, resulting in the misappropriation of our trade secret and/or confidential information, and we may not have an adequate remedy for any such breach. In addition, our trade secret and/or confidential information may become known or be independently developed by a third party, or misused by any collaborator to whom we disclose such information. Despite any measures taken to protect our intellectual property, unauthorized parties may attempt to or successfully copy aspects of our products or to obtain or use information that we regard as proprietary without our consent. As a result, we may be unable to sufficiently protect our trade secrets and proprietary information.

We also seek to preserve the integrity and confidentiality of our data and trade secrets by maintaining physical security of our premises and physical and electronic security of our information technology systems. Despite any measures taken to protect our data and intellectual property, unauthorized parties may attempt to or successfully gain access to and use information that we regard as proprietary. See “Risk Factors—Risks Relating to Our Operations—Our internal computer systems may fail or suffer security breaches.”

We also own a number of registered trademarks and pending trademark applications. As of the Latest Practicable Date, we had registered trademarks for our Company and our corporate logo in China and other jurisdictions and are seeking trademark protection for our Company and our corporate logo in other jurisdictions where available and appropriate.

As of the Latest Practicable Date, we were not involved in any legal, arbitral or administrative proceedings or claims of infringement of any intellectual property rights, in which we may be a claimant or a respondent. Our Directors confirm that they are not aware of any legal, arbitral or administrative proceedings of infringement of any third parties’ intellectual property rights by us as of the Latest Practicable Date. For details, see “Appendix

BUSINESS

VI—Statutory and General Information—Further Information about Our Business—Intellectual Property Rights.” For risks related to intellectual property rights, see “Risk Factors—Risks Relating to Our Intellectual Property Rights.”

COMPETITION

The market in which we operate is characterized by rapid changes resulting from technological advances and scientific discoveries. In addition, it is subject to changes in the overall healthcare industry in China and globally. While we believe that our product development experience and robust R&D capabilities provide us with competitive advantages, we face potential competition from various sources, including major international medical device companies as well as domestic medical device manufacturers which are also developing insulin pumps, CGMS, artificial pancreas and other diabetes management medical devices.

We compete primarily on the basis of our products’ proven track record of efficacy and safety, our first-mover advantage in the Chinese market, brand recognition among hospitals and physicians and the level of technical support and training we provide to physicians. We believe that our continued success depends on our ability to (i) innovate and develop advanced technology; (ii) apply our technology across product lines; (iii) develop a broad portfolio of proprietary products; (iv) maintain our efficient operating model; (v) attract and retain skilled personnel; (vi) maintain high quality standards; (vii) obtain and maintain regulatory approvals; and (viii) effectively market our products.

Several of our competitors have significantly greater financial and other resources and may have longer track records and greater expertise in R&D, clinical trial, obtaining regulatory approvals and commercialization of approved products and may enjoy wide brand name recognition globally. Mergers and acquisitions in the medical devices industry may result in even more resources being concentrated among a small number of our competitors. Smaller or early stage companies may also prove to be significant competitors, particularly through collaborative arrangements with large and established companies. These competitors also compete with us in recruiting and retaining qualified scientific and management personnel, establishing clinical trial sites and patient registration for clinical trials, as well as in acquiring technologies or products complementary to, or necessary for, our products.

Our competitors dedicate, and we believe they will continue to dedicate, significant resources to promote their products aggressively. They may develop technologies and products that are safer, more effective, easier to use or less expensive than ours. They may also obtain FDA, NMPA or other regulatory approval for their products earlier than we obtain approval for ours, which could result in our competitors establishing a strong market position ahead of us. We may encounter physicians, especially in the global market, who are committed to or prefer the products offered by our competitors due to existing relationships with our competitors. Any of these events could reduce or eliminate our commercial opportunities.

For competitive landscape of our products and product candidates, see “—Our Products and Product Pipeline” and “Industry Overview.”

BUSINESS

EMPLOYEES

As of the Latest Practicable Date, we had 391 employees in total. The following table sets forth the number of our employees categorized by function as of the Latest Practicable Date.

Function	Number
Manufacturing	114
Sales and Marketing	123
Product Development	90
Quality Control	25
General and Administrative	39
Total	391

Substantially all of our employees are stationed in China. In compliance with the applicable labor laws, we enter into individual employment contracts with our employees covering matters such as wages, bonuses, employee benefits, workplace safety, confidentiality obligations, non-competition and grounds for termination. These employment contracts typically have terms of three years.

To remain competitive in the labor market, we provide various incentives and benefits to our employees. We invest in continuing education and training programs, including internal and external training, for our management staff and other employees to upgrade their skills and knowledge. We also provide competitive salaries and stock incentive plans to our employees, especially our key employees.

We require all of our employees, especially those who involved in sales and marketing and business development activities, to abide by our anti-bribery and anti-corruption compliance requirements and applicable laws and regulations to eliminate bribery and corruption risks. We closely monitor our employee’s compliance with anti-bribery and anti-corruption policies.

During the Track Record Period and up to the Latest Practicable Date, we did not experience any strikes, labor disputes or industrial action which had a material effect on our business, and we consider our relations with our employees to be good. As of the Latest Practicable Date, save as disclosed in “—Legal Proceedings and Compliance,” we had complied with statutory social security insurance fund and housing fund obligations applicable to us under applicable laws in all material respects.

BUSINESS

Employment Agreements with Key Management and R&D Staff

We normally enter into standard confidentiality, non-compete employment agreements with our key management and R&D staff. The non-compete agreement typically prohibits the employee from competing with us, directly or indirectly, during his or her employment and for at least two years after the termination of his or her employment. The agreements also typically include undertakings regarding assignment of inventions and discoveries made during the course of his or her employment. For further details regarding the terms of confidentiality and employment agreements with our key management, see “Directors, Supervisors and Senior Management.”

Our employees are represented by relevant labor unions. We believe that we maintain good working relationships with our employees and we did not experience any significant labor disputes or any significant difficulty in recruiting staff for our operations during the Track Record Period and up to the Latest Practicable Date.

INSURANCE

We maintain insurance policies covering our property and equipment that we believe are sufficient in accordance with customary industry practice. We do not carry any product liability insurance or business interruption insurance. See “Risk Factors—Risks Relating to Our Operations—Our insurance coverage may not completely cover the risks related to our business and operations” for further details of risk relating to our current insurance coverage. To minimize our product liability risk, we have instituted quality control measures in order to avoid or reduce the incidence of product defects. See “—Quality Control” above for further details of our quality control system.

PROPERTIES AND FACILITIES

We are headquartered in Hangzhou, Zhejiang province, China, with an aggregate area of approximately 20,000 sq.m. in use. This include approximately 15,000 sq.m., including a 1,500 sq.m. ISO Class 7 clean-room space and an 80 sq.m. ISO Class 8 clean-room space, for the production and pre-delivery inspection of our products. We own all of our production facilities and workshops. As of the Latest Practicable Date, none of our owned properties were subject to any encumbrance, mortgage, lien or pledge. We have obtained the building ownership certificates and the related land use right certificates for all of our owned properties which had been put into production and use.

We do not engage in any property activities as defined in Rule 5.01 of the Listing Rules. We do not have any property interest with a carrying amount of 15% or more of our consolidated total assets as of December 31, 2020. Therefore, according to Chapter 5 of the Listing Rules and section 6(2) of the Companies (Exemption of Companies and Prospectuses from Compliance with Provisions) Notice (Chapter 32L of the Laws of Hong Kong), this Document is exempted from compliance with the requirements of section 38(1) of the

BUSINESS

Companies (Winding Up and Miscellaneous Provisions) Ordinance in relation to paragraph 34(2) of the Third Schedule to the Companies (Winding Up and Miscellaneous Provisions) Ordinance which requires a valuation report with respect to all of our Group’s interests in land or buildings.

We rent an office with an aggregate area of approximately 120 sq.m. in Shanghai, China. The lease agreement provides a duration of two years. As of the Latest Practicable Date, we had not registered the lease agreement with the competent PRC authorities. As advised by our PRC Legal Advisor, failure to complete the registration of such lease agreement may lead to a fine ranging from RMB1,000 to RMB10,000 imposed by the relevant PRC authorities.

ENVIRONMENTAL PROTECTION, OCCUPATIONAL HEALTH AND SAFETY

We are subject to various environmental protection and occupational health and safety laws and regulations. Our operations involve the use of hazardous and flammable chemical materials. Our operations also produce such hazardous waste. We generally contract with third parties for the disposal of these materials and wastes. During the Track Record Period, we were not subject to any material claims, lawsuits, penalties or administrative actions which had a material and adverse effect on our business, financial condition or results of operations relating to noncompliance with applicable PRC environmental and occupational health and safety laws and regulations.

We strive to provide a safe working environment for our employees. We have implemented work safety guidelines setting out safety practices, accident prevention and accident reporting. Our employees responsible for manufacturing and quality control and assurance are required to hold relevant qualifications, as well as wear the proper safety gear when working. We conduct regular safety inspections and maintenance for our manufacturing facility.

RISK MANAGEMENT AND INTERNAL CONTROL

Risk Management

We recognize that risk management is critical to the success of our business. Key operational risks faced by us include changes in the general market conditions and the regulatory environment of the Chinese and global medical devices markets, our ability to develop, manufacture and commercialize our products and product candidates, and our ability to compete with other medical device companies. For details of various risks and uncertainties we face, see “Risk Factors.” We also face various financial risks. In particular, we are exposed to credit, liquidity, and foreign exchange risks that may arise in the normal course of our business.

We have adopted a consolidated set of risk management policies which set out a risk management framework to identify, assess, evaluate and monitor key risks associated with our strategic objectives on an on-going basis. Our Audit Committee and ultimately our Directors

BUSINESS

supervise the implementation of our risk management policies. Risks identified by our management will be analyzed on the basis of likelihood and impact, and will be properly followed up and mitigated and rectified by our Group and reported to our Directors.

The following key principles outline our Group’s approach to risk management and internal control:

Our senior management oversees and manages the overall risks associated with our business operations, including (i) reviewing and approving our risk management policy to ensure that it is consistent with our corporate objectives; (ii) monitoring the most significant risks associated with our business operations and our management’s handling of such risks; and (iii) ensuring the appropriate application of our risk management framework across our Group.

Our legal and internal audit personnel are responsible for developing and implementing our risk management policy and carrying out our day-to-day risk management practice, such as assessing risks on key business operations, advising risk responses and optimizing risk management policies. In order to formalize risk management across our Group and set a common level of transparency and risk management performance, the relevant departments will (i) gather information about the risks relating to their operation or function; (ii) conduct risk assessments, which include the identification, prioritization, measurement and categorization of all key risks that could potentially affect their objectives; (iii) continuously monitor the key risks relating to their operation or function; (iv) implement appropriate risk responses where necessary; and (v) develop and maintain an appropriate mechanism to facilitate the application of our risk management framework.

We consider that our Directors and members of our senior management possess the necessary knowledge and experience in providing good corporate governance oversight in connection with risk management and internal control.

Intellectual Property Rights Risk Management

Compliance with applicable PRC and overseas laws and regulations, especially laws and regulations governing the protection of our intellectual property rights and the prevention of liabilities resulting from potential illegal content of publication and intellectual properties infringement are major focus areas of our operational risk management. Our legal department is responsible for approving contracts, monitoring any changes in the applicable laws and regulations and ensuring the ongoing compliance of our operations with the applicable law and regulations.

Our intellectual property department assists in conducting searches to help ensure that all of our intellectual property is under the protection of relevant laws and regulations, and also helps ensure the application for trademark, copyright or patent registrations for, as well as filing with relevant authorities of all of our products. The intellectual property department shall then administer the execution process of obtaining the necessary filings, approvals, and/or licenses. Other than some standard contracts which have been reviewed and adopted by the

BUSINESS

legal department, all the contracts of our Company are required to be reviewed and approved by our legal department prior to execution. In addition, we establish policies for intellectual property infringement notices to help ensure timely monitoring the infringement incidents.

Internal Control

Our Board is responsible for establishing our internal control system and reviewing its effectiveness. During the Track Record Period, we regularly reviewed and enhanced our internal control system. As of the Latest Practicable Date, there were no material outstanding issues relating to our Groups internal control. Below is a summary of the internal control policies, measures and procedures we have implemented or plan to implement:

- We have adopted various measures and procedures regarding each aspect of our operations, such as protection of intellectual property, environmental protection and occupational health and safety. We provide periodic training on these measures and procedures to our employees as part of our employee training program. We also regularly monitor the implementation of those measures and procedures through our on-site internal audit team for each stage of the produce development process.
- Our Directors (who are responsible for monitoring the corporate governance of our Group) with assistance from our legal advisers, will periodically review our compliance status with all relevant laws and regulations after the [REDACTED].
- We have established the Audit Committee which shall (i) make recommendations to our Directors on the appointment and removal of external auditors; and (ii) review the financial statements and render advice in respect of financial reporting as well as oversee the risk management and internal control procedures of our Group. For more details, see “Directors, Supervisors and Senior Management—Board Committees—Audit Committee.”
- We have engaged Orient Capital (Hong Kong) Limited as compliance adviser upon [REDACTED] to provide advice to our Directors and management team until the end of the first fiscal year after the [REDACTED] regarding matters relating to the Listing Rules. Our compliance adviser is expected to ensure our use of the [REDACTED] from the [REDACTED] complies with the section entitled “Future Plans and Use of [REDACTED]” in this Document after the [REDACTED], as well as to provide support and advice regarding the requirements of relevant regulatory authorities in a timely fashion.
- We will engage a PRC legal adviser to advise us on and keep us abreast with PRC laws and regulations after the [REDACTED]. We will continue to arrange various training to be provided by external legal advisors from time to time when necessary and/or any appropriate accredited institution to update our Directors, Supervisors, members of our senior management and relevant employees on the latest applicable laws and regulations.

BUSINESS

- We maintain strict anti-corruption policies among our sales personnel and distributors in our sales and marketing activities. We also monitor our sales and marketing personnel to ensure their compliance with applicable promotion and advertising requirements, which include restrictions on promoting our products for unapproved uses or patient populations, also known as off-label use, and limitations on industry-sponsored scientific and educational activities.
- We maintain a comprehensive treasury policy, detailing specific functions and internal control measures for capital use. These functions and measures include but are not limited to procedures of capital management, separation of capital management responsibilities, liquidity management and follow-up and analysis of the implementation of capital plan.
- Our Directors believe that compliance creates value for us. We are dedicated to cultivating a compliance culture among all of our employees. To ensure such compliance culture is embedded into everyday workflow and set the expectations for individual behavior across our Group, we conduct regular internal compliance checks and inspections, adopt strict accountability internally and conduct compliance training.
- We will comply with the Corporate Governance Code. We have established four board committees, namely, the Audit Committee, the Remuneration and Assessment Committee, the Nomination Committee and the Strategy Committee, with respective terms of reference in compliance with the Corporate Governance Code. For details, see “Directors, Supervisors and Senior Management.”
- We have adopted internal protocols governing both the confidentiality and privacy for patient sample and data. There is written operation procedures in place for sample/data collection, test procedures, data storage as well as data access. Such data access is on an as-needed basis for internal employees, and external access is not allowed and requires written approvals from the head of the quality control/compliance department.

LEGAL PROCEEDINGS AND COMPLIANCE

Legal Proceedings

We may be involved in legal proceedings in the ordinary course of business from time to time. During the Track Record Period and up to the Latest Practicable Date, none of us or our Directors were involved in any litigation, arbitration or administrative proceedings which would have a material and adverse impact on our business, financial condition or results of operations. As of the Latest Practicable Date, we were not aware of any pending or threatened material litigation, arbitration or administrative proceedings against us or any of our Directors, which individually or in the aggregate would have a material adverse effect on our business, financial condition or results of operations.

BUSINESS

Compliance

During the Track Record Period and up to the Latest Practicable Date, we did not have any non-compliance incidents which our Directors believe would, individually or in the aggregate, have a material operational or financial impact on our business as a whole. As advised by our PRC Legal Advisor, during the Track Record Period and up to the Latest Practicable Date, we had complied with the applicable laws and regulations in all material respects, except for the non-compliance which would not have a material adverse effect on our business as a whole.

During the Track Record Period and as of the Latest Practicable Date, we did not make full contributions to the social insurance and housing funds for certain employees in accordance with the relevant PRC laws and regulations. During the Track Record Period and as of the Latest Practicable Date, we engaged third-party human resources agencies to pay social insurance and housing funds for certain employees, primarily due to the preference of such employees to participate in local social insurance and housing fund schemes in their place of residency. Under the agreements entered into between such third-party human resources agencies and us, the third-party human resources agencies have the obligations to pay social insurance premium and housing funds for our relevant employees. If the human resource agencies fail to pay the social insurance or housing fund contributions for our employees as required under applicable PRC laws and regulations, we may be subject to penalties imposed by the local social insurance authorities and the local housing fund management centers for failing to discharge our obligations in relation to payment of social insurance and housing funds as an employer. These third-party human resources agencies have confirmed in writing that they have paid such contributions in compliance with applicable PRC laws and regulations. As of the Latest Practicable Date, we had not received any administrative penalty or labor arbitration application from employees for our agency arrangement with third-party human resources agencies.

Pursuant to relevant PRC laws and regulations, the relevant PRC authorities may demand us to pay the outstanding social insurance contributions within a stipulated deadline and we may be liable to a late payment fee equal to 0.05% of the outstanding amount for each day of delay. If we fail to make such payments, we may be liable to a fine of one to three times the amount of the outstanding contributions. With respect to a failure to pay the full amount of housing funds as required, the housing funds management center in China may require payment of the outstanding amount within a prescribed period. If the payment is not made within such time limit, an application may be made to the PRC courts for compulsory enforcement. See “Risk Factors—Risks relating to doing business in China—We may be subject to penalties under relevant PRC laws and regulations due to failure to be in full compliance with social insurance and housing funds regulation.”

Our Directors believe that such non-compliance would not have a material adverse effect on our business or results of operations, considering that: (i) we had not been subject to any administrative actions, fines or penalties during the Track Record Period and up to the Latest Practicable Date due to such non-compliance; (ii) as of the Latest Practicable Date, we had not

BUSINESS

received any notification from the relevant PRC authorities requiring us to pay for the shortfalls or any overdue charges with respect to social insurance and housing funds; (iii) we were neither aware of any employee complaints filed against us nor involved in any labor disputes with our employees with respect to social insurance and housing funds during the Track Record Period and up to the Latest Practicable Date; and (iv) as advised by our PRC Legal Advisor, considering relevant regulatory policies and the facts stated above, such non-compliance will not have a material adverse effect on our financial condition or results of operations as a whole and the [REDACTED]. We made provisions of RMB2.1 million as of December 31, 2020 in connection with the shortfall amount of the social insurance and housing provident fund contribution during the Track Record Period.

We plan to make full payment of social insurance and housing provident fund contributions as soon as possible in compliance with relevant PRC laws and regulations. We have enhanced our internal control measures, including implementing a policy on social insurance and housing provident fund contribution in compliance with relevant PRC laws and regulations. In addition, we have designated our human resources department to review and monitor the reporting and contributions of social insurance and housing provident fund and we will consult our PRC legal counsel on a regular basis for advice on relevant PRC laws and regulations to keep us abreast of relevant regulatory developments.

LICENSES AND PERMITS

As of the Latest Practicable Date, we had obtained all requisite licenses, approvals and permits from relevant authorities that are material to our operations. The table below sets forth the relevant details of the material licenses required for our operation in the PRC and overseas:

<u>License/Permit</u>	<u>Holder</u>	<u>Grant Date</u>	<u>Expiration Date</u>
Medical Device Production License (《醫療器械生產許可證》)	the Company	November 16, 2020	February 23, 2025
Registration Certificate for Medical Device (《醫療器械註冊證》, No. 國械註准20173153333)	MicroTech Medical	September 12, 2017	September 11, 2022
Registration Certificate for Medical Device (《醫療器械註冊證》, No. 國械註准20173663330)	MicroTech Medical	June 1, 2018	August 31, 2022
Registration Certificate for Medical Device (《醫療器械註冊證》, No. 國械註准20173543312)	MicroTech Medical	May 15, 2019	August 28, 2022
Registration Certificate for Medical Device (《醫療器械註冊證》, No. 浙械註准20172400420)	MicroTech Medical	April 25, 2017	April 24, 2022

BUSINESS

<u>License/Permit</u>	<u>Holder</u>	<u>Grant Date</u>	<u>Expiration Date</u>
Registration Certificate for Medical Device (《醫療器械註冊證》, No. 浙械註准20172400509)	MicroTech Medical	May 22, 2017	May 21, 2022
Registration Certificate for Medical Device (《醫療器械註冊證》, No. 浙械註准20172400981)	MicroTech Medical	September 6, 2017	September 5, 2022
Registration Certificate for Medical Device (《醫療器械註冊證》, No. 浙械註准20172401051)	MicroTech Medical	September 29, 2017	September 28, 2022
Record Certificate for II Medical Devices Operation (《第二類醫療器械經營備案憑證》)	the Company	November 25, 2020	N/A
Medical Devices Operation Permit (《醫療器械經營許可證》)	Hangzhou E-commerce	November 26, 2020	November 25, 2025
Record Certificate for II Medical Devices Operation (《第二類醫療器械經營備案憑證》)	Hangzhou E-commerce	November 25, 2020	N/A
Qualification Certificate for Internet Drug Information Services (《互聯網藥品資訊服務資格證書》)	Hangzhou E-commerce	December 28, 2020	April 26, 2025
Record Certificate for Internet Medical Devices Sales (《醫療器械網路銷售備案憑證》, No. (浙杭)網械企備字[2021]00024)	Hangzhou E-commerce	January 7, 2021	N/A
Record Certificate for Internet Medical Devices Sales (《醫療器械網路銷售備案憑證》, No. (浙杭)網械企備字[2021]00025)	Hangzhou E-commerce	January 7, 2021	N/A
Record Certificate for Internet Medical Devices Sales (《醫療器械網路銷售備案憑證》, No. (浙杭)網械企備字[2020]00545)	Hangzhou E-commerce	January 6, 2021	N/A
EC certificate for Medical Device, No. HD 1582538-1	MicroTech Medical	March 31, 2021	April 23, 2024
EC certificate for In Vitro Diagnostic Medical Device, No. HL 1582538-1	MicroTech Medical	March 31, 2021	April 23, 2024
Certificate of Quality Management System EN ISO 13485:2016	MicroTech Medical	March 31, 2021	April 23, 2023

BUSINESS

AWARDS AND RECOGNITION

The table below sets forth a summary of the major awards and recognitions for which we received government grants as of the Latest Practicable Date:

<u>Award and Recognition</u>	<u>Year of Award/Grant</u>	<u>Award/Grant Authority</u>
Innovative Medical Device (insulin pump)	2018	The Ministry of Science and Technology of the PRC
Leading Innovation Team (intelligent cognitive computed based closed loop artificial pancreas)	2017	Leading Group for Talent Work of the CPC Zhejiang Provincial Committee
National Major Scientific Research Program in 13th Five-Year Plan Period (construction and application of cloud-based AI diabetes management platform for children and adolescents with diabetes)	2016	The Ministry of Science and Technology of the PRC
Made-in-Zhejiang Excellence	2016	Zhejiang Provincial Economic and Information Commission/Zhejiang Provincial Development and Reform Commission
Technology Innovation Project of Small and Medium-sized Enterprises (patch insulin pump system)	2014	The Ministry of Science and Technology of the PRC
Key Diabetes Diagnostics and Therapy Medical Device Research Center in Zhejiang Province	2014	The Government of Zhejiang Province
Major Science and Technology Program of Zhejiang Province (second-generation patch insulin pump system)	2014	Zhejiang Provincial Department of Science and Technology
Special Program for the Development of Information Service Industry in Zhejiang Province (cloud-based diabetes management platform)	2014	Zhejiang Province Economic and Information Commission

DIRECTORS, SUPERVISORS AND SENIOR MANAGEMENT

BOARD OF DIRECTORS

Our Board of Directors comprises ten Directors, including four executive Directors, two non-executive Directors and four independent non-executive Directors. Our Directors serve a term of three years and may be re-elected for successive reappointments.

The following table sets out information in respect of the Directors.

Name	Age	Position/Title	Date of Appointment	Date of Joining our Group	Role and Responsibility
Executive Directors					
Dr. Zheng Pan (鄭攀)	[50]	Chairman of the Board of Directors	March 14, 2016	January 2011	Overall strategic planning, business direction and operational management
		Executive Director	April 21, 2021		
		Chief Executive Officer	January 20, 2011		
Dr. Yu Fei (于非)	[39]	Executive Director	April 21, 2021	July 2016	Formulation of product development plans and management of R&D matters in respect of technology, project management and intellectual properties
Ms. Liu Xiu (劉秀)	[41]	Executive Director Financial Controller Secretary to the Board	April 21, 2021 August 10, 2020 October 30, 2020	August 2020	Financial matters management, information disclosure of the Company, and organizing Board and Shareholders' meetings
Ms. Xu Fangling (徐方玲)	[37]	Executive Director Head of Administration Department	April 21, 2021 December 6, 2013	December 2013	Management of public relations, investor relations, investment and financing matters and administrative commerce matters

DIRECTORS, SUPERVISORS AND SENIOR MANAGEMENT

Name	Age	Position/Title	Date of Appointment	Date of Joining our Group	Role and Responsibility
Non-executive Directors					
Mr. Hu Xubo (胡旭波)	[46]	Non-executive Director	April 21, 2021	November 2016	Overseeing Board affairs and giving strategic advice and guidance on the business operation of the Group
Ms. Gao Yun (高韻)	[34]	Non-executive Director	April 21, 2021	May 2020	Overseeing Board affairs and giving strategic advice and guidance on the business operation of the Group
Independent Non-executive Directors					
Dr. Li Lihua (厲力華)	[56]	Independent Non-executive Director	April 21, 2021	October 2020	Participating in the decision making for our Company’s significant events and advising on issues relating to corporate governance, audit and the remuneration and assessment of our Directors, Supervisors and senior management

DIRECTORS, SUPERVISORS AND SENIOR MANAGEMENT

Name	Age	Position/Title	Date of Appointment	Date of Joining our Group	Role and Responsibility
Ms. Gao Jian (高健)	[47]	Independent Non-executive Director	April 21, 2021	October 2020	Participating in the decision making for our Company’s significant events and advising on issues relating to corporate governance, audit and the remuneration and assessment of our Directors, Supervisors and senior management
Ms. Wang Chunfeng (王春鳳)	[39]	Independent Non-executive Director	April 21, 2021	October 2020	Participating in the decision making for our Company’s significant events and advising on issues relating to corporate governance, audit and the remuneration and assessment of our Directors, Supervisors and senior management
Mr. Ho Kin Cheong Kelvin (何建昌)	[53]	Independent Non-executive Director	April 21, 2021	April 21, 2021	Participating in the decision making for our Company’s significant events and advising on issues relating to corporate governance, audit and the remuneration and assessment of our Directors, Supervisors and senior management

DIRECTORS, SUPERVISORS AND SENIOR MANAGEMENT

Executive Directors

Dr. Zheng Pan (鄭攀), aged [50], is the chairman of our board, an executive Director and the Chief Executive Officer of our Company. Dr. Zheng founded our Company in January 2011 and has been the chairman of the Board since March 2016 and the Chief Executive Officer of our Company since January 2011, respectively. He was re-designated as an executive Director of our Company in April 2021. He is primarily responsible for the overall strategic planning, business direction and operational management of our Company.

Dr. Zheng has nearly 20 years of experience in the healthcare industry. Prior to founding our Company, he successively served as a research assistant and a postdoc in Florida State University from 1999 to September 2004 in the United States. In 2005, Dr. Zheng also served as a senior mechanical engineer at Centurion Wireless Technologies. He also served as a manager at Flextronics San Jose Medical Products Center (美國偉創力聖荷西醫療產品中心), a medical solution provider company from April 2006 to July 2010.

Dr. Zheng obtained the qualification of professorate senior engineer (教授級高級工程師) from Zhejiang Provincial Department of Human Resources and Social Security (浙江省人力資源和社會保障廳) in July 2012. Dr. Zheng was selected into the first batch of “521” Talents for Global Talents Introduction (杭州市第一批全球引才“521”人才) by Municipal Party Committee Organization Department (Talent Office) (杭州市委人才工作領導小組辦公室) in August 2011, and he won the Innovation Achievement Award of Overseas Returnee Contributions Awards (中國僑界貢獻獎(創新成果)) from All-China Federation of Returned Overseas Chinese in September 2014.

Dr. Zheng received a bachelor’s degree from Zhejiang Institute of Technology (浙江工學院) in the PRC with a major in Machine Design and Production Engineering in July 1993, a master’s degree from Zhejiang University (浙江大學) in the PRC with a major in Mechanics in March 1996 and a Ph.D. degree with a major in Mechanical Engineering from Florida State University in the United States in August 2004.

Dr. Yu Fei (于非), aged [39], is an executive Director and the director of R&D Department of our Company. Dr. Yu joined our Group in July 2016 and was re-designated as our executive Director in April 2021. He is primarily responsible for the formulation of product development plans and management of R&D matters in respect of technology, project management and intellectual properties.

Prior to joining our Group, Dr. Yu served as a senior biomedical engineer in the Diabetes Division of Medtronic PLC. (美國美敦力公司), a medical technology company, from May 2013 to July 2016, where he was responsible for researching, developing, deploying and validating new electrochemical biosensor system. He has been serving as the R&D director and a director of our Company since August 2016 and October 2020, respectively.

Dr. Yu received a bachelor’s degree in Bioengineering from National University of Singapore in Singapore on June 30, 2007 and a Ph.D. degree in biomedical engineering from University of Southern California in the United States in May 2013.

DIRECTORS, SUPERVISORS AND SENIOR MANAGEMENT

Ms. Liu Xiu (劉秀), aged [41], is an executive Director, the financial controller and secretary to the Board of our Group. Ms. Liu joined our Group in August 2020 and was re-designated as our executive Director in April 2021. She is primarily responsible for the financial matters management, information disclosure of the Company, and organizing Board and Shareholders’ meetings.

Prior to joining our Group, Ms. Liu served in multiple companies and has over 17 years of experience in financial and investment areas. From July 2003 to September 2012, Ms. Liu served various positions in Pan-China Certified Public Accountants LLP (天健會計師事務所), including, among others, senior project manager and manager. She then served as the financial director in Zhejiang University Dajing Venture Capital Co., Ltd. (浙江浙大大晶創業投資有限公司), formerly known as Zhejiang University Venture Capital Co., Ltd. (浙江大學創業投資有限公司) from September 2012 to June 2017. During June 2017 to April 2020, she served successively as the risk control director of Investment Department of Wanma United Holding Group Co., Ltd. (浙江萬馬智能科技集團有限公司) and the partner of Hangzhou Silicon Valley True Stone Asset Management Co., Ltd. (杭州矽谷真石資產管理有限公司). Ms. Liu has been serving as an independent director of Ningbo Jiangfeng Electronic Materials Co., Ltd. (寧波江豐電子材料股份有限公司), a company listed on the Shenzhen Stock Exchange (stock code: 300666), since December 2020. She has been serving as the financial controller, the secretary to the Board and a director of our Company since August 2020, October 2020 and October 2020, respectively.

Ms. Liu received a bachelor’s degree in finance from Central China Normal University (華中師範大學) in the PRC in June 2003 and a graduation certificate in Economics from Zhejiang University (浙江大學) in the PRC in October 2012. She was qualified as a certified public accountant in April 2003 by Ministry of Finance of the People’s Republic of China, an internal auditor in November 2004 by Institute of Internal Auditors, the senior accountant in April 2015 by Zhejiang Provincial Department of Human Resources and Social Security with authorization from the Provincial Senior Accountant Qualification Review Committee.

Ms. Xu Fangling (徐方玲), aged [37], is an executive Director and the head of Administration Department of our Company. Ms. Xu joined our Group in December 2013 and was re-designated as our executive Director in April 2021. She is primarily responsible for the management of public relations, investor relations, investment and financing matters and administrative commerce matters.

Prior to joining our Group, Ms. Xu served as the financial supervisor of Hangzhou Shidai Zhifeng Technology Co., Ltd. (杭州時代之峰科技有限公司), from March 2007 to December 2013. She has been serving as the head of the Administrative Department and a director of our Company since December 2013 and October 2020, respectively.

Ms. Xu graduated from Henan Vocational College of Information and Statistics (河南信息統計職業學院) (previously known as Henan Planning and Statistics School (河南省計劃統計學校)) in the PRC in July 2003 with a major in Accounting Statistics. Ms. Xu graduated from Zhejiang University of Technology (浙江工業大學) with the specialist qualifications in the PRC in June 2015 with a major in accounting. She has been attending the courses for a bachelor’s degree in Zhejiang University of Technology in the PRC since February 2019.

DIRECTORS, SUPERVISORS AND SENIOR MANAGEMENT

Non-executive Directors

Mr. Hu Xubo (胡旭波), aged [46], is a non-executive Director of our Company. Mr. Hu joined our Group in November 2016 and was re-designated as our non-executive Director in April 2021. He is primarily responsible for overseeing Board affairs and giving strategic advice and guidance on the business operation of the Group.

Mr. Hu has over 14 years of experience in investment management, strategic consulting and operations management in the biomedicine industry. He joined Qiming Weichuang Venture Capital Management (Shanghai) Co. Ltd (啟明維創創業投資管理(上海)有限公司) in October 2006 and is currently a managing partner of the firm. Mr. Hu is also a director of Shanghai Sanyou Medical Co. Ltd (上海三友醫療器械股份有限公司), a company listed on the Shanghai Stock Exchange (stock code: 688085), APT Medical Inc. (深圳惠泰醫療器械股份有限公司), a company listed on the Shanghai Stock Exchange (stock code: 688617) and Amoy Diagnostics Co., Ltd. (廈門艾德生物醫藥科技股份有限公司), a company listed on the Shenzhen Stock Exchange (stock code: 300685). From October 2014 to April 2018, Mr. Hu also served as a non-executive director of BBI Life Sciences Corporation (BBI生命科學有限公司) (previously listed on the Stock Exchange (stock code: 1035.HK), delisted in June 2020). Mr. Hu was a non-executive director of Antengene Corporation Limited (德琪醫藥有限公司), a company listed on the Stock Exchange (stock code: 06996) from November 2018 to March 2021. Mr. Hu has been serving as a director of our Company since November 1, 2016.

Mr. Hu received a bachelor’s degree in preventive medicine from Shanghai Medical College of Fudan University (formerly known as Shanghai Medical University (上海醫科大學)) in the PRC in July 1998. He also obtained a master’s degree in business administration from Ecole Nationale des Ponts et Chaussees (Tongji campus) in the PRC in October 2004.

Ms. Gao Yun (高韻), aged [34], is a non-executive Director of our Company since May 2020. Ms. Gao joined our Group in May 2020 and was re-designated as our non-executive Director in April 2021. She is primarily responsible for overseeing Board affairs and giving strategic advice and guidance on the business operation of the Group.

Between August 2011 and January 2014, Ms. Gao served successively as an analyst and then senior analyst in IMS Health. In February 2014, she joined the Medtronic PLC. (美國美敦力公司), a medical technology company, as the specialist in the Strategy and Business Development Department for a certain period of time. After that, Ms. Gao also worked at SBCVC (HK) Ltd. (軟銀中國資本有限公司) as the investment manager. She has been successively serving as the investment manager, the senior investment manager and the vice president at Lilly Asia Ventures (禮來亞洲基金), an investment fund.

DIRECTORS, SUPERVISORS AND SENIOR MANAGEMENT

Ms. Gao received a bachelor’s degree in medicine from Fudan University in the PRC in June 2011 and a master’s degree in business administration from China Europe International Business School (中歐國際工商學院) in the PRC in December 2016.

Independent Non-executive Directors

Dr. Li Lihua (厲力華), aged [56], was appointed as an independent director of our Company in October 2020 and re-designated as an independent non-executive Director in April 2021. He is primarily responsible for participating in the decision making for our Company’s significant events and advising on issues relating to corporate governance, audit and the remuneration and assessment of our Directors, Supervisors and senior management.

From 1994 to 2006, Dr. Li served successively as an assistant professor and an associate professor at the Medical School in University of South Florida. Since June 2006, he has been serving as the Dean of the Institute of Biomedical Engineering and Instrumentation of Hangzhou Dianzi University (杭州電子科技大學).

Dr. Li is a notable individual in the scientific field. He was selected into the New Century 151 Talent Project (新世紀151人才工程) of Zhejiang by Zhejiang Province New Century 151 Talent Project Joint Conference Office (浙江省“新世紀151人才工程”聯席會議辦公室) in December 2006 and “Qianjiang Scholar” Distinguished Professor of Zhejiang Higher Education Institution (浙江省高等學校“錢江學者”特聘教授) by Zhejiang Provincial Department of Education Office (浙江省教育廳辦公室) in August 2006. Dr. Li once served as an associate editor of Medical Physics, an international authoritative journal, the Editorial Board Member of Cancer Information, and the project reviewer of the U.S. Institutes of Health and the Department of Defense, and was listed in the Marquis Who’s Who in America. Dr. Li was the winner of the Third Prize of Science and Technology Progress Award of the State Education Commission (國家教委科技進步三等獎) in 1991 and National Science Fund for Distinguished Young Scholars (國家傑出青年科學基金) granted by National Natural Science Foundation of China (國家自然科學基金委員會) in September 2007. He also received the Overseas Chinese Contribution Award - Innovative Talent Award (僑界貢獻獎創新人才獎) granted by All-China Federation of Returned Overseas Chinese (中華全國歸國華僑聯合會) in August 2012.

Dr. Li obtained his Ph.D. degree in signal and information processing from Southeast University in the PRC in November 1990. Dr. Li was also a member of Academic Advisory Committee of Zhijiang Laboratory (之江實驗室學術諮詢委員會) since March 2018.

DIRECTORS, SUPERVISORS AND SENIOR MANAGEMENT

Ms. Gao Jian (高健), aged [47], was appointed as an independent director of our Company in October 2020 and re-designated as an independent non-executive Director in April 2021. She is primarily responsible for participating in the decision making for our Company’s significant events and advising on issues relating to corporate governance, audit and the remuneration and assessment of our Directors, Supervisors and senior management.

Ms. Gao has extensive experience in accounting and financial areas. Prior to joining our Group, she successively served as the vice general manager and the secretary to the Board of Eastern Shenghong Co., Ltd. (江蘇東方盛虹股份有限公司) (formerly known as Jiangsu Wujiang China Eastern Silk Market Co.,Ltd. (江蘇吳江中國東方絲綢市場股份有限公司)), whose shares are listed on the Shenzhen Stock Exchange (stock code: 000301) from November 2010 to June 2011; the independent non-executive director of Kuaijishan Shaoxing Rice Wine Company Limited. (會稽山紹興酒股份有限公司), whose shares are listed on the Shanghai Stock Exchange (stock code: 601579) since September 2019.

Ms. Gao received a bachelor’s degree in accounting from Zhejiang University of Finance and Economics (浙江財經大學) in the PRC in 1995. Ms. Gao is also a certified practising accountant since June 1998, a senior accountant, a certified public valuer, a tax advisor and a qualified practising lawyer since August 1998. She obtained the permission of practising securities and futures related businesses from Ministry of Finance (財政部) and China Securities Regulatory Commission (中國證券監督管理委員會) as a certified practising accountant since November 2002.

Ms. Wang Chunfeng (王春鳳), aged [39], was appointed as an independent director of our Company in October 2020 and re-designated as an independent non-executive Director in April 2021. She is primarily responsible for participating in the decision making for our Company’s significant events and advising on issues relating to corporate governance, audit and the remuneration and assessment of our Directors, Supervisors and senior management.

Ms. Wang served successively as the supervisor and securities affairs representative of Enjoyor Co., Ltd. (銀江股份有限公司), whose shares are listed on the Shenzhen Stock Exchange (stock code: 300020) from September 2007 to July 2010. She has been serving successively as the chief executive officer and the vice chairperson of Yinjiang Incubator Co., Ltd. (銀江孵化器股份有限公司) from June 2018 to January 2021 and since February 2021 respectively.

Ms. Wang received a master’s degree in business administration from Lanzhou University of Technology (蘭州理工大學) in the PRC in December 2015. She was granted the third prize of Hangzhou Science and Technology Progress Award (杭州市科技進步三等獎) by Hangzhou Science and Technology Bureau (杭州市科學技術局) in October 2011.

DIRECTORS, SUPERVISORS AND SENIOR MANAGEMENT

Mr. Ho Kin Cheong Kelvin (何建昌), aged [53], was appointed as an independent non-executive Director on April 21, 2021, effective upon [REDACTED]. He is responsible for participating in the decision making for our Company’s significant events and advising on issues relating to corporate governance, audit and the remuneration and assessment of our Directors, Supervisors and senior management.

Mr. Ho has over 20 years of experience in finance and accounting, company secretary, initial public offering and debt restructuring areas. Mr. Ho worked at Grand Orient Holdings Limited (偉東集團有限公司) (stock code: 0106.HK) from June 1999 to October 2000, serving as the company secretary and chief financial officer. From December 2000 to November 2003, he worked for Hanny Magnetics Limited, a subsidiary of Hanny Holdings Limited (錦興集團有限公司) (currently known as Master Glory Group Limited) (stock code: 0275.HK) at which his last position was financial analyst. From January 2004 to September 2005, he worked for Friedmann Pacific Greater China Investments Limited (富泰大中華投資有限公司) (stock code: 1226.HK) as the company secretary and chief financial officer. From August 2006 to August 2008, he worked for Anhui Tianda Oil Pipes Company Limited (安徽天大石油管材有限公司) (stock code: 0839.HK) as company secretary and chief financial officer. From August 2008 to January 2010, he worked for FU JI Food and Catering Services Holdings Limited (福記食品服務有限公司) (currently known as Fresh Express Delivery Holdings Group Co., Limited) (stock code: 1175.HK) as company secretary and chief financial officer. From April 2010 to March 2012 and from May 2012 to December 2014, he worked for Greens Holdings Limited (格菱控股有限公司) (stock code: 1318.HK) at which his last position was company secretary and chief financial officer. From January 2016 to December 2017, he worked for Sand River Golf Club Limited (沙河高爾夫球會有限公司) as the company secretary and chief financial officer. From March 2019 to May 2020, he worked for Richly Field China Development Limited (裕田中國發展有限公司) (stock code: 0313.HK) as the company secretary and chief financial officer. Since August 2020, Mr. Ho has been the company secretary and chief financial officer of China Wood International Holding Co., Limited (中木國際控股有限公司) (stock code: 1822.HK).

Mr. Ho was an independent non-executive director of Cheung Tai Hong Holdings Limited (currently known as ITC Properties Group Limited) (祥泰行集團有限公司) (stock code: 0199.HK) from October 2001 to May 2003 and a non-executive director of HongDa Financial Holding Limited (currently known as China Wood International Holding Co., Limited) (stock code: 1822.HK) (弘達金融控股有限公司) from April 2016 to April 2017. Since August 2018, Mr. Ho has been an independent non-executive director of CECEP COSTIN New Materials Group Limited (In Provisional Liquidation) (中國節能海東青新材料集團有限公司) (“**CECEP COSTIN**”) (stock code: 2228.HK). Based on published information, CECEP COSTIN received a winding up petition and a summons for the appointment of joint provisional liquidators dated October 2017. Mr. Ho’s appointment was made subsequent to the winding up petition against CECEP COSTIN and he was appointed by the joint provisional liquidators to meet the relevant requirements under the Listing Rules. Since July 2020, Mr. Ho has been an independent non-executive director of Rosan Resources Holdings Limited (融信資源控股有限公司) (stock code: 0578.HK). Since August 2020, he has been an independent non-executive director of Green Leader Holdings Group Limited (綠領控股集團有限公司) (stock code: 0061.HK). Since October 2020, he has been an independent non-executive director of Yadong Group Holdings Limited (亞東集團控股有限公司) (stock code: 1795.HK) and JW (Cayman) Therapeutics Company., Limited (藥明巨諾(開曼)有限公司) (stock code: 2126.HK). Notwithstanding the

DIRECTORS, SUPERVISORS AND SENIOR MANAGEMENT

above appointments as independent non-executive director, Mr. Ho confirmed that he will devote sufficient time to act as an independent non-executive Director of our Company. In addition, Mr. Ho acting as independent non-executive director is neither a full-time member of the above-mentioned listed companies nor involved in day-to-day operations or management of the above-mentioned listed companies, and as such he has no executive or management responsibility.

Mr. Ho was admitted as an associate member of the Hong Kong Society of Accountants (currently known as The Hong Kong Institute of Certified Public Accountants) in June 1997 and a fellow member of The Association of Chartered Certified Accountants in the United Kingdom in April 2002. He has passed the Securities Broker Examination of The Stock Exchange of Hong Kong Limited in March 2000.

Mr. Ho obtained a bachelor degree of business administration from Hong Kong Baptist College (currently known as Hong Kong Baptist University) in Hong Kong in November 1990.

SUPERVISORY COMMITTEE

The Supervisory Committee currently consists of three Supervisors as of the date of this Document. The Supervisors include two shareholder Supervisors and one employee Supervisor. The shareholder Supervisors and the employee Supervisor are elected at the Shareholders' meetings and the staff representative assembly, respectively, for a term of three years, subject to re-election upon their retirement or resignation.

The following table sets out information in respect of the Supervisors.

<u>Name</u>	<u>Age</u>	<u>Position/Title</u>	<u>Date of Appointment</u>	<u>Date of Joining our Group</u>	<u>Role and Responsibility</u>
Mr. Li Zhenhua (李振華)	[33]	Chairman of the Supervisory Committee	October 2020	September 2012	Supervising the performance of our Directors and members of senior management and performing other supervisory duties as a Supervisor
		Employee Supervisor	October 2020		

DIRECTORS, SUPERVISORS AND SENIOR MANAGEMENT

<u>Name</u>	<u>Age</u>	<u>Position/Title</u>	<u>Date of Appointment</u>	<u>Date of Joining our Group</u>	<u>Role and Responsibility</u>
Mr. Lv Cheng (呂承)	[33]	Shareholders’ Representative Supervisor	October 2020	October 2020	Supervising the performance of our Directors and members of senior management and performing other supervisory duties as a Supervisor
Mr. Zhao Zhiheng (趙志恆)	[38]	Shareholders’ Representative Supervisor	October 2020	August 2013	Supervising the performance of our Directors and members of senior management and performing other supervisory duties as a Supervisor

Supervisors

Mr. Li Zhenhua (李振華), aged [33], is the chairman of our Supervisory Committee and an employee Supervisor. Mr. Li joined our Group in September 2012 as the senior production manager of production department and was appointed as the Supervisor of our Company in October 2020. He is primarily responsible for supervising the performance of our Directors and members of senior management and performing other supervisory duties as a Supervisor.

Prior to joining the Group, Mr. Li worked in Hangzhou Tingyi Food Co., Ltd. (杭州頂益食品有限公司) from July 2009 to September 2012. He has been serving as the senior production manager of production department of our Company since September 2012.

Mr. Li graduated from Quzhou University (衢州學院) (formerly known as Zhejiang University of Technology, West Zhejiang Branch (浙江工業大學浙西分校)) in the PRC in June 2009 with a major in mechanical manufacturing and automation. He obtained his bachelor’s degree in mechanical manufacturing and automation from China University of Petroleum (中國石油大學) in the PRC in January 2018.

Mr. Lv Cheng (呂承), aged [33], is a shareholders’ representative Supervisor. Mr. Lv joined our Group in October 2020 as a Supervisor. He is primarily responsible for supervising the performance of our Directors and members of senior management and performing other supervisory duties as a Supervisor.

DIRECTORS, SUPERVISORS AND SENIOR MANAGEMENT

Mr. Lv has been successively serving as the investment manager and investment director of LYZZ Capital (上海醴澤投資管理有限公司), an investment company, since February 2017, where he was responsible for investment matters.

Mr. Lv received a bachelor’s degree in business administration from Glion Institute of Higher Education in Switzerland in May 2012 and a master’s degree in tourism administration from George Washington University in the United States in May 2015.

Mr. Zhao Zhiheng (趙志恆), aged [38], is a shareholders’ representative Supervisor. Mr. Zhao joined our Group in August 2013 as the manager of purchasing department. He is primarily responsible for supervising the performance of our Directors and members of senior management and performing other supervisory duties as a Supervisor.

Prior to joining our Group, he was the sole proprietor of Hangzhou Shangcheng District Xiuyushanju Handicraft Shop (杭州市上城區秀玉山居工藝品店) from January 2010 to December 2012.

Mr. Zhao graduated from Zhejiang University City College (浙江大學城市學院) in the PRC with a major in financial analysis in February 2007. He obtained his bachelor’s degree in logistics management from Huazhong University of Science and Technology (華科技大學) in the PRC in July 2019.

SENIOR MANAGEMENT

The following table sets out information regarding the members of senior management of our Company.

<u>Name</u>	<u>Age</u>	<u>Position/Title</u>	<u>Date of Appointment</u>	<u>Date of Joining our Group</u>	<u>Role and Responsibility</u>
Dr. Zheng Pan (鄭攀)	[50]	Chief Executive Officer	January 2011	January 2011	Overall strategic planning, business direction and operational management
Mr. Dore Chin Mark	[51]	Vice President	October 2020	March 2011	International business/product/technical development in our Company, international and domestic technology partnerships, and assisting in the management of the R&D team and international registration matters

DIRECTORS, SUPERVISORS AND SENIOR MANAGEMENT

Name	Age	Position/Title	Date of Appointment	Date of Joining our Group	Role and Responsibility
Mr. Lan Yi (兰毅)	[50]	Vice President	January 13, 2020	July 2016	Management of domestic sales and customer service and assisting the Chief Executive Officer to manage the work of the marketing department
Ms. Liu Xiu (劉秀)	[41]	Financial Controller	August 2020	August 2020	Financial matters management, information disclosure of the Company, and organizing Board and Shareholders’ meetings
		Secretary to the Board	October 2020		

Dr. Zheng Pan (鄭攀), aged [50], is the chairman of our board, an executive Director and the Chief Executive Officer of our Company. For details of his biography, see “—Board of Directors.”

Mr. Dore Chin Mark, aged [51], is the vice president of the engineering department of our Company. Mr. Mark joined our Group in March 2011. He is primarily responsible for international business/product/technical development in our Company, international and domestic technology partnerships, and assisting in the management of the R&D team and international registration matters.

Prior to joining our Group in 2011, Mr. Mark worked at Mizuho OSI, an orthopedic surgery company, as a Senior Manager for New Product Development from May 2010. Before working at Mizuho OSI, he served as a Senior Manager in Flex Ltd. (previously known as Flextronics International Ltd.) (stock code: FLEX (NASDAQ)), a multinational contract manufacturer, from October 2006 to December 2009, where he was responsible for mechanical engineering. Between 1999 to 2006, Mr. Mark served as a Senior Mechanical Engineer at Gecko Design Inc., a design company acquired by Google LLC.

Mr. Mark received a master’s degree in mechanical engineering from the University of California, Irvine, in the USA in 1993 and a bachelor’s degree in mechanical engineering from the University of California, Los Angeles in the USA in 1992. He also received Project Management Professional (PMP) certification granted by the Project Management Institute in 2010.

DIRECTORS, SUPERVISORS AND SENIOR MANAGEMENT

Mr. Lan Yi (兰毅), aged [50], is the vice president of marketing of our Company. Mr. Lan joined our Group in July 2016. He is primarily responsible for the management of domestic sales and customer service and assisting the Chief Executive Officer to manage the work of the marketing department.

Mr. Lan has more than 20 years of experience in the pharmaceutical and medical device industries. Prior to joining our Group, Mr. Lan served as the regional manager of the Diabetes Division of United States Eli Lilly (Asia) Co., Ltd. (美國禮來(亞洲)有限公司) from September 1996 to February 2004. He then joined the Medtronic (Shanghai) Management Co., Ltd. (美敦力(上海)管理有限公司), serving as the national sales manager of the Diabetes Division from March 2004 to June 2013. He served as the national sales manager of Luye Pharma Group Ltd. (綠葉製藥集團有限公司) from July 2013 to June 2016.

Mr. Lan received a bachelor’s degree in science and technology English from West China University of Medical Sciences (華西醫科大學) in the PRC in July 1994 and a master’s degree in business administration from Washington University (St. Louis) in the United States in December 2009.

Ms. Liu Xiu (劉秀), aged [41], is an executive Director, the financial controller and secretary to the Board of our Company. For details of her biography, see “—Board of Directors.”

DIRECTORS’, SUPERVISORS’ AND SENIOR MANAGEMENT’S INTERESTS

Save as disclosed above, each of our Directors, Supervisors and members of senior management has not been a director of any public company the securities of which are listed on any securities market in Hong Kong or overseas in the three years immediately preceding the date of this Document.

None of our Directors has any interests in any business, which competes or is likely to compete, either directly or indirectly, with our business which would require disclosure under Rule 8.10 of the Listing Rules.

None of our Directors, Supervisors and members of the senior management is related to other Directors, Supervisors and members of the senior management.

Save as disclosed herein, to the best knowledge, information and belief of our Directors and Supervisors having made all reasonable enquiries, there was no other matter with respect to the appointment of our Directors and Supervisors that needs to be brought to the attention of the Shareholders and there was no information relating to our Directors and Supervisors that is required to be disclosed pursuant to Rule 13.51(2)(h) to (v) of the Listing Rules as of the Latest Practicable Date.

DIRECTORS, SUPERVISORS AND SENIOR MANAGEMENT

As of the Latest Practicable Date, save for the interests in the shares of the Company held by Dr. Zheng Pan, our executive Director and Mr. Hu Xubo, our non-executive Director, which are disclosed in the section headed “Statutory and General Information—Further Information about Our Directors, Supervisors, Senior Management and Substantial Shareholders”, none of our Directors, Supervisors and senior management held any interest in our Company as set out in Part XV of the Securities and Futures Ordinance as at the Latest Practicable Date.

JOINT COMPANY SECRETARIES

Mr. Duo Bo (朵波), aged [30], was appointed as a joint company secretary in April 2021. Mr. Duo served as an investment bank business assistant at Xinjiang Westeast Economic Research Institute (新疆東西部經濟研究院) from August 2015 to February 2016. He then worked at Bode Century Enterprise Management Consulting Co., Ltd. (深圳博得世紀企業管理顧問股份有限公司), serving as investment and financing manager and the head of information disclosure from March 2016 to January 2019. After that, Mr. Duo joined Shenzhen Ruijie Engineering Consulting Co., Ltd. (深圳瑞捷工程諮詢股份有限公司), serving as the securities commissioner from March 2019 to May 2020. Since January 2021, he has been serving as the securities commissioner and legal affairs officer of our Company.

Mr. Duo received a bachelor’s degree in Accounting from Jiujiang University (九江學院) in the PRC on July 10, 2016. Mr. Duo obtained the Securities Qualification Certificate from China Securities Industry Association in March 2015 and was qualified as the secretary of the board of directors by National Equities Exchange and Quotations Co., Ltd. in December 2017. He obtained the legal professional qualification certificate granted by the Ministry of Justice of the PRC in April 2021.

Mr. Zhang Mengchi (張夢弛), aged [35], was appointed as the other joint company secretary of our Company in April 2021, effective upon [REDACTED]. Mr. Zhang is an assistant manager of SWCS Corporate Services Group (Hong Kong) Limited.

Mr. Zhang received a master’s degree in Professional Accounting and Corporate Governance from the City University of Hong Kong on July 14, 2017, and is an associate member of both the Hong Kong Institute of Chartered Secretaries and the Chartered Governance Institute in the United Kingdom.

BOARD COMMITTEES

Our Board delegates certain responsibilities to various committees. In accordance with the relevant PRC laws and regulations and the Corporate Governance Code, Appendix 14 to the Listing Rules, our Company has formed four Board committees, namely the Audit Committee, the Remuneration and Assessment Committee, the Nomination Committee and the Strategy Committee.

DIRECTORS, SUPERVISORS AND SENIOR MANAGEMENT

Audit Committee

We have established an Audit Committee with written terms of reference in compliance with Rule 3.21 of the Listing Rules and paragraph C.3 and paragraph D.3 of the Corporate Governance Code, Appendix 14 to the Listing Rules. The Audit Committee consists of three Directors, namely Ms. Gao Jian, Mr. Ho Kin Cheong Kelvin and Ms. Gao Yun. Ms. Gao Jian, who holds the appropriate professional qualifications as required under Rules 3.10(2) and 3.21 of the Listing Rules, serves as the chairman of the Audit Committee. The primary duties of the Audit Committee include, but not limited to, the following:

- proposing the appointment or change of external auditors to our Board, and coordinating the communication between internal audit and external audit;
- examining the financial information of our Company and the disclosure of related matters;
- supervising the financial reporting system, risk management and internal control system of our Company;
- monitoring the misconduct in the financial reports and internal control of our Company;
- performing corporate governance responsibilities;
- examining the scientificity, rationality, effectiveness and implementation of the internal control system of our Group, and making recommendations on the accountability of those responsible for violations;
- reviewing major connected transactions according to the mandate granted by the Board; and
- dealing with other matters that are authorized by our Board or involved in laws, regulations, regulatory documents, Hong Kong Listing Rules, Articles of Association, and the rules of procedure of the Board.

DIRECTORS, SUPERVISORS AND SENIOR MANAGEMENT

Remuneration and Assessment Committee

We have established a Remuneration Committee with written terms of reference in compliance with paragraph B.1 of the Corporate Governance Code, Appendix 14 to the Listing Rules. The Remuneration Committee consists of three Directors, namely Ms. Wang Chunfeng, Mr. Ho Kin Cheong Kelvin and Ms. Xu Fangling. Ms. Wang Chunfeng serves as the chairman of the Remuneration Committee. The primary duties of the Remuneration Committee include, but not limited to, the following:

- performing responsibilities set out in the relevant code provisions of the Corporate Governance Code in Appendix 14 of the Hong Kong Listing Rules (as amended from time to time);
- formulating individual remuneration plans for Directors, Supervisors and members of the senior management in accordance with the terms of reference of the job responsibilities, the importance of their positions as well as the remuneration benchmarks for the relevant positions in the other comparable companies;
- making recommendations to the Board on the overall remuneration policy and structure of the Directors and senior management of our Company, and formulating a remuneration policy on the establishment of formal and transparent procedures (the remuneration of executive Directors should be largely linked to the company and individual performance);
- examining and resolving remuneration proposals from the management in accordance with the corporate policies and objectives set by the Board;
- making recommendations to the Board on the remuneration package of individual executive Directors and senior management, which should include non-pecuniary benefits, pension rights and compensation amounts (including compensation for loss or termination of office or appointment);
- making recommendations to the Board on the remuneration of non-executive Directors (including independent non-executive directors);
- considering the salary, time and responsibilities of peer companies, and the employment conditions of other positions in our Group;
- examining and resolving the compensation payable to executive Directors and senior management for the loss or termination of their duties or appointments to ensure that such compensation is consistent with the terms of the contract;

DIRECTORS, SUPERVISORS AND SENIOR MANAGEMENT

- examining the criteria of performance evaluation of Directors, Supervisors and the senior management of our Company, and conducting annual performance evaluation;
- supervising the implementation of the remuneration plan of the Company; and
- dealing with other matters that are authorized by the Board.

Nomination Committee

We have established a Nomination Committee with written terms of reference in compliance with paragraph A.5 of the Corporate Governance Code, Appendix 14 to the Listing Rules. The Nomination Committee consists of three Directors, namely Dr. Li Lihua, Ms. Gao Jian and Dr. Zheng Pan. Dr. Li Lihua serves as the chairman of the Nomination Committee. The primary duties of the Nomination Committee include, but not limited to, the following:

- making recommendations to our Board with regards to the size and composition of our Board based on our Company's business operations, asset scale and equity structure;
- researching and developing standards and procedures for the election of our Board members, general managers and members of the senior management, and making recommendations to our Board;
- conducting extensive search and providing to our Board suitable candidates for Directors, general managers and other members of the senior management;
- examining our Board candidates, general manager and members of the senior management and making recommendations to our Board;
- examining at least annually the structure, number, composition and diversity of members of the Board (including skills, knowledge, experience, gender, age, cultural and educational background, and service tenure) based on the business activities, asset scale and equity structure of our Company, and making recommendations on any changes to the Board that are proposed to match the strategy of our Company;
- evaluating the structure of the committees under the Board, making recommendations on the directors to serve as members of relevant committees, and submitting to the Board for approval;

DIRECTORS, SUPERVISORS AND SENIOR MANAGEMENT

- formulating, examining, implementing and supervising (if applicable) Director nomination policies, and disclosing them in the corporate governance report of our Company every year;
- formulating, examining and implementing the Board diversity policy, monitoring the progress towards the goals set for the implementation of relevant policies, and disclosing relevant policies or policy summaries in the corporate governance report every year, including any measurable targets set for the implementation of the policies and their achievement progress towards these goals;
- implementing any related matters that enable the committee to perform the powers and functions delegated by the Board; and
- dealing with other matters that are authorized by our Board.

Strategy Committee

We have also established a Strategy Committee. The Strategy Committee consists of three Directors, namely Dr. Zheng Pan, Dr. Li Lihua and Mr. Hu Xubo. Dr. Zheng Pan serves as the chairman of the committee. The primary duties of the Strategy Committee include, but not limited to, the following:

- researching and making recommendations on our Company's long-term development strategy plan;
- researching and making recommendations on the major investment and financing plans, and major capital operation and asset management projects required by the Articles of Association to be approved by our Board or the general meeting of the Company;
- making recommendations on other major issues that shall affect our Company's development, and examining relevant matters accordingly;
- inspecting the implementation of the above matters approved by the Board or the general meeting of the Company; and
- dealing with other matters that are authorized by our Board.

DIRECTORS, SUPERVISORS AND SENIOR MANAGEMENT

EMPLOYMENT ARRANGEMENT OF SENIOR MANAGEMENT

We normally enter into (i) an employment contract, (ii) a non-competition agreement, and (iii) a confidentiality agreement with each of our senior management members. The key terms of such contracts are set forth below.

- *Terms:* We normally enter into three years' or non-fixed term employment contract with our senior management members.
- *No-competition:* the non-competition obligations shall subsist throughout the employee's period of employment and up to 24 months after termination of employment. During the non-competition period, without prior written consent or confirmation from the Company, the employee shall not (i) in his/her own name or in other identities, directly or indirectly participate in business related to developing or selling similar products developed or sold by the Company; (ii) instigate, induce, solicit or encourage any employee of the company to leave the Company, or solicit any client or the business of the client; (iii) engage in a business (self-owned or others') of the same industry as the Company, or hold any position (part time or full time) in any other entity which competes with our Company.

Confidentiality

- *Confidential information:* The employee shall keep confidential the following business-related information of our Company: (i) technical information: including but not limited to technical solutions, the preparation and performance of major equipment, engineering design, computer design, manufacturing methods, formulas, process flow, technical indicators, computer softwares, test results, drawings, samples, models, molds, operation manuals, technical documents, corresponding faxes, correspondence; (ii) management information: including but not limited to management methods, customer lists, sales channels and networks, procurement information, product prices, pricing policies, financial information, procurement channels, quality control information and production operation guides; (iii) production information: trial production information, important production stages and locations; (iv) other information.
- *Obligation and duration:* The employee shall not: (i) obtain any confidential information unrelated to his or her own occupation or business by any improper means; (ii) disclose any confidential information to any third party who does not undertake any confidential obligations to the Company; (iii) permit or assist any third party who does not undertake any confidential obligations to utilize the confidential information of our Company; (iv) utilize the confidential information of our Company for self-employed purposes. If the employee discovers any leakage of or negligent disclosure of the confidential information, the relevant employee shall

DIRECTORS, SUPERVISORS AND SENIOR MANAGEMENT

take effective measures to prevent further leakage, and shall report to the Company timely. Such obligation of confidentiality shall subsist for the term of his or her employment and thereafter, and until the relevant information has become fully public.

Intellectual Property Rights

- *Acknowledgement:* Our Company owns the intellectual property rights such as patents, trademarks, copyrights, and any other activities involving relevant intellectual property rights conducted by the employees, inventors, designers, writers and signatories shall be authorized by the Company except for the rights legally owned by such persons.
- *Assignment:* When performing tasks of the Company, if the employees consider it necessary to apply for patents, trademarks, copyrights and other intellectual property rights, they shall apply in a timely manner after the approval of the legal representative of the Company. The employees shall comply with the confidential obligation before the public announcement or legal authorization in relation to any of the aforementioned applications.

REMUNERATION OF DIRECTORS, SUPERVISORS AND SENIOR MANAGEMENT

During the reporting period, certain Directors and Supervisors who did not hold management positions in the company did not receive remuneration from the Company; independent non-executive Directors only received independent non-executive Directors' allowances from the Company. Other Directors, Supervisors, and senior managers receive their remuneration in the form of salary and annual bonuses.

For the years ended December 31, 2019 and 2020, the aggregate amount of remuneration paid or payable to our Directors amounted to RMB57.5 million and RMB68.1 million, respectively.

For the years ended December 31, 2019 and 2020, the aggregate amount of remuneration paid or payable to our Supervisors amounted to nil and RMB3.6 million, respectively.

Under the arrangement currently in force, we estimate the total compensation before taxation to be accrued to our Directors and our Supervisors for the year ending December 31, 2021 to be approximately RMB4.0 million.

The remuneration paid by our Company to the five highest paid individuals (including Directors and Supervisors) for the years ended December 31, 2019 and December 31, 2020 were RMB61.4 million and RMB83.2 million respectively.

DIRECTORS, SUPERVISORS AND SENIOR MANAGEMENT

We confirmed that during the Track Record Period, no remuneration was paid by our Company to, or receivable by, our Directors, Supervisors or the five highest paid individuals as an inducement to join or upon joining our Company or as compensation for loss of office in connection with the management positions of any subsidiary of our Company.

During the Track Record Period, none of our Directors or Supervisors waived any remuneration. Save as disclosed above, no other payments have been paid, or are payable, by our Company or our subsidiary to our Directors, Supervisors or the five highest paid individuals during the Track Record Period.

CORPORATE GOVERNANCE

Our Company is committed to achieving high standards of corporate governance with a view to safeguarding the interests of our Shareholders. To accomplish this, our Company intends to comply with Corporate Governance Code set out in Appendix 14 to the Listing Rules and the Model Code for Securities Transactions by Directors of Listed Issuers set out in Appendix 10 to the Listing Rules after the [REDACTED].

Pursuant to code provision A.2.1 of the Corporate Governance Code, companies listed on the Stock Exchange are expected to comply with, but may choose to deviate from the requirement that the responsibilities between the chairman and the chief executive officer should be segregated and should not be performed by the same individual. We do not have a separate chairman and Chief Executive Officer and Dr. Zheng currently performs these two roles. Our Board believes that, in view of his experience, personal profile and his roles in our Company as mentioned above, Dr. Zheng is the Director best suited to identify strategic opportunities and focus of the Board due to his extensive understanding of our business as our Chief Executive Officer. The Board also believes that vesting the roles of both chairman and Chief Executive Officer in the same person has the benefit of (i) ensuring consistent leadership within the Group, (ii) enabling more effective and efficient overall strategic planning and execution of strategic initiatives of the Board, and (iii) facilitating the flow of information between the management and the Board for the Group. The Board considers that the balance of power and authority for the present arrangement will not be impaired and this arrangement will enable the Company to make and implement decisions promptly and effectively. The Board will continue to review and consider splitting the roles of chairman of the Board and the Chief Executive Officer of the Company at a time when it is appropriate by taking into account the circumstances of the Group as a whole.

DIRECTORS, SUPERVISORS AND SENIOR MANAGEMENT

BOARD DIVERSITY POLICY

In order to enhance the effectiveness of our Board and to maintain the high standard of corporate governance, we have adopted the board diversity policy which sets out the objective and approach to achieve and maintain diversity of our Board. Pursuant to the board diversity policy, we seek to achieve Board diversity through the consideration of a number of factors when selecting the candidates to our Board, including but not limited to gender, skills, age, professional experience, knowledge, cultural, education background, ethnicity and length of service. The ultimate decision of the appointment will be based on merit and the contribution which the selected candidates will bring to our Board.

Our Directors have a balanced mix of knowledge and skills, including overall management and strategic development, quality assurance and control, finance and accounting and corporate governance in addition to industry experience in healthcare and biotechnology. They obtained degrees in various majors including science, engineering and finance. We have four independent non-executive Directors with different industry backgrounds, representing more than one third of the members of our Board. Furthermore, our Board has a diverse age and gender representation. Taking into account our existing business model and specific needs as well as the different background of our Directors, the composition of our Board satisfies our board diversity policy.

Our Nomination Committee is responsible for ensuring the diversity of our Board members. After the [REDACTED], our Nomination Committee will review the board diversity policy from time to time to ensure its continued effectiveness and we will disclose in our corporate governance report about the implementation of the board diversity policy on an annual basis.

COMPLIANCE ADVISOR

We have appointed Orient Capital (Hong Kong) Limited as our Compliance Advisor pursuant to Rules 3A.19 and 19A.05 of the Listing Rules. The Compliance Advisor will provide us with guidance and advice as to compliance with the Listing Rules and other applicable laws, rules, codes and guidelines. Pursuant to Rule 3A.23 of the Listing Rules, the Compliance Advisor will advise our Company in certain circumstances including:

- (a) before the publication of any regulatory announcement, circular or financial report;
- (b) where a transaction, which might be a notifiable or connected transaction, is contemplated, including share issues and share repurchases;
- (c) where we propose to use the [REDACTED] of the [REDACTED] in a manner different from that detailed in this Document or where our business activities, developments or results deviate from any forecast, estimate or other information in this Document; and

DIRECTORS, SUPERVISORS AND SENIOR MANAGEMENT

- (d) where the Hong Kong Stock Exchange makes an inquiry to our Company regarding unusual movements in the price or trading volume of its [REDACTED] securities or any other matters in accordance with Rule 13.10 of the Listing Rules.

Pursuant to Rule 19A.06 of the Listing Rules, the Compliance Advisor will, on a timely basis, inform our Company of any amendment or supplement to the Listing Rules that are announced by the Hong Kong Stock Exchange. The Compliance Advisor will also inform our Company of any new or amended law, regulation or code in Hong Kong applicable to us, and advise us on the continuing requirements under the Listing Rules and applicable laws and regulations.

The term of the appointment will commence on the [REDACTED] and is expected to end on the date on which our Company complies with Rule 13.46 of the Listing Rules in respect of our financial results for the first full financial year commencing after the [REDACTED].

EMPLOYEE INCENTIVE SCHEMES

We established two Employee Incentive Platforms, namely Hangzhou Yantai and Hangzhou Hengtai. The two Employee Incentive Platforms, in aggregate, held 34,729,562 Domestic Shares of the Company as of the Latest Practicable Date. For the details of the Employee Incentive Platforms, see “Appendix VI—Statutory and General Information—Further Information About Our Directors, Supervisors, Senior Management and Substantial Shareholders—5. Employee Incentive Schemes.”

RELATIONSHIP WITH OUR SINGLE LARGEST GROUP OF SHAREHOLDERS

OUR SINGLE LARGEST GROUP OF SHAREHOLDERS

Immediately prior to the [REDACTED], our Company is owned as to 24.52% by Dr. Zheng, 5.29% by Hangzhou Yantai and 4.36% by Hangzhou Hengtai. Hangzhou Yantai and Hangzhou Hengtai are Employee Incentive Platforms, both of which are controlled by Dr. Zheng, being a sole general partner of Hangzhou Yantai and Hangzhou Hengtai. Therefore, Dr. Zheng, directly and through Hangzhou Yantai and Hangzhou Hengtai, controlled approximately 34.17% of our total issued share capital as of the Latest Practicable Date. Therefore, Dr. Zheng, Hangzhou Yantai and Hangzhou Hengtai constitute our Controlling Shareholders (as defined under the Listing Rules) before [REDACTED]. Immediately following the completion of the [REDACTED] and assuming the [REDACTED] is not exercised, Dr. Zheng, Hangzhou Yantai and Hangzhou Hengtai will control approximately [REDACTED]% of our total issued share capital. Therefore, they will not be regarded as our Controlling Shareholders upon [REDACTED], but they will remain as our Single Largest Group of Shareholders upon [REDACTED].

For details of Hangzhou Yantai and Hangzhou Hengtai, each being an Employee Incentive Platform, see “History, Development and Corporate Structure.”

INDEPENDENCE FROM OUR SINGLE LARGEST GROUP OF SHAREHOLDERS

Our Directors consider that we are capable of carrying on our business independently from our Single Largest Group of Shareholders and their close associates after the [REDACTED], taking into consideration the factors below.

Management Independence

We are able to carry on our business independently from the Single Largest Group of Shareholders from a management perspective. Our Board consists of 10 Directors, including 4 executive Directors, 2 non-executive Directors and 4 independent non-executive Directors.

- (a) each Director is aware of his/her fiduciary duties as a director which require, among other things, that he/she acts for the benefit and in the interest of our Company and does not allow any conflict between his/her duties as a Director and his/her personal interests;
- (b) our daily management and operations are carried out by a senior management team, all of whom have substantial experience in the industry in which our Company is engaged, and will therefore be able to make business decisions that are in the best interests of our Group. For details of the industry experience of our senior management team, see “Directors, Supervisors and Senior Management”;

RELATIONSHIP WITH OUR SINGLE LARGEST GROUP OF SHAREHOLDERS

- (c) we have 4 independent non-executive Directors and certain matters of our Company must always be referred to the independent non-executive Directors for review;
- (d) in the event that there is a potential conflict of interest arising out of any transaction to be entered into between our Group and a Director and/or his/her associate, he/she shall abstain from voting and shall not be counted towards the quorum for the voting; and
- (e) we have adopted a series of corporate governance measures to manage conflicts of interest, if any, between our Group and the Single Largest Group of Shareholders which would support our independent management. For details, see “—Corporate Governance.”

Based on the above, our Directors believe that our Board as a whole and together with our senior management are able to perform the managerial role in our Group independently from the Single Largest Group of Shareholders and their close associates after the [REDACTED].

Operational Independence

We do not rely on the Single Largest Group of Shareholders and their close associates for our business development, staffing, logistics, administration, finance, internal audit, information technology, sales and marketing, or company secretarial functions. We have our own departments specializing in these respective areas which have been in operation and are expected to continue to operate separately and independently from the Single Largest Group of Shareholders and their close associates. In addition, we have our own headcount of employees for our operations and management for human resources.

We have independent access to suppliers and customers and an independent management team to handle our day-to-day operations. We are also in possession of all relevant licenses, certificates, facilities and intellectual property rights necessary to carry on and operate our principal businesses and we have sufficient operational capacity in terms of capital and employees to operate independently.

Based on the above, our Directors believe that we are able to operate independently of the Single Largest Group of Shareholders and their close associates.

FINANCIAL INDEPENDENCE

We have an independent financial system and make financial decisions according to our Group’s own business needs. We have internal control and accounting systems and an independent finance department for discharging the treasury function. We do not expect to rely on the Single Largest Group of Shareholders and their close associates for financing after the [REDACTED] as we expect that our working capital will be funded by cash flows generated from operating activities, bank loans as well as the [REDACTED] from the [REDACTED].

RELATIONSHIP WITH OUR SINGLE LARGEST GROUP OF SHAREHOLDERS

In addition, we are capable of obtaining financing from independent third parties without relying on any guarantee or security provided by our Single Largest Group of Shareholders or their respective associates. As of the Latest Practicable Date, there was no outstanding loans or guarantees provided by or granted to the Single Largest Group of Shareholders or their respective associates. During the Track Record Period and as of the Latest Practicable Date, we had received a series of [REDACTED] Investments from third party investors independently. For details of the [REDACTED] Investments, see “History, Development and Corporate Structure.”

Based on the above, our Directors believe that we do not place undue reliance on the Single Largest Group of Shareholders upon the [REDACTED].

INTERESTS OF THE SINGLE LARGEST GROUP OF SHAREHOLDERS IN OTHER BUSINESSES

Save for the interests of the Single Largest Group of Shareholders in our Company and its subsidiary, the Single Largest Group of Shareholders and the Directors confirm that as of the Latest Practicable Date, they did not have any interest in a business, apart from the business of our Group, which competes or is likely to compete, directly or indirectly, with our business, which would require disclosure under Rule 8.10 of the Listing Rules.

CORPORATE GOVERNANCE

Our Company will comply with the provisions of the Corporate Governance Code in Appendix 14 to the Listing Rules (the “**Corporate Governance Code**”), which sets out principles of good corporate governance.

Our Directors recognize the importance of good corporate governance in protection of our Shareholders’ interests. We would adopt the following measures to safeguard good corporate governance standards and to avoid potential conflict of interests between our Group and the Single Largest Group of Shareholders:

- (a) where a Shareholders’ meeting is to be held for considering proposed transactions in which the Single Largest Group of Shareholders or any of their respective associates has a material interest, the Single Largest Group of Shareholders will not vote on the resolutions and shall not be counted in the quorum in the voting;
- (b) our Company has established internal control mechanisms to identify connected transactions. Upon the [REDACTED], if our Company enters into connected transactions with a substantial shareholder or any of his/its associates, our Company will comply with the applicable Listing Rules;
- (c) the independent non-executive Directors will review, on an annual basis, whether there is any conflict of interests between the Group and the Single Largest Group of Shareholders (the “**Annual Review**”) and provide impartial and professional advice to protect the interests of our minority Shareholders;

RELATIONSHIP WITH OUR SINGLE LARGEST GROUP OF SHAREHOLDERS

- (d) the Single Largest Group of Shareholders will undertake to provide all information necessary, including all relevant financial, operational and market information and any other necessary information as required by the independent non-executive Directors for the Annual Review;
- (e) our Company will disclose decisions (with basis) on matters reviewed by the independent non-executive Directors either in its annual report or by way of announcements;
- (f) where our Directors reasonably request the advice of independent professionals, such as financial advisors, the appointment of such independent professionals will be made at our Company’s expenses; and
- (g) we have appointed Orient Capital (Hong Kong) Limited as our Compliance Advisor to provide advice and guidance to us in respect of compliance with the Listing Rules, including various requirements relating to corporate governance.

Based on the above, our Directors are satisfied that sufficient corporate governance measures have been put in place to manage conflicts of interest between our Group and the Single Largest Group of Shareholders, and to protect minority Shareholders’ interests after the [REDACTED].

SUBSTANTIAL SHAREHOLDERS

SUBSTANTIAL SHAREHOLDERS

So far as our Directors are aware, immediately following completion of the [REDACTED] and assuming the [REDACTED] is not exercised, the following persons will have interests and/or short positions in the Shares or underlying shares of our Company which would fall to be disclosed pursuant to the provisions of Divisions 2 and 3 of Part XV of the SFO:

Name of Shareholder	Nature of Interest	Number and class of Shares held ⁽¹⁾	Approximate percentage of shareholding in the total share capital of our Company as of the date of this Document (%)	Approximate percentage of shareholding in the relevant class of Shares after the [REDACTED] ⁽¹⁾ (%)	Approximate percentage of shareholding in the total share capital of our Company after the [REDACTED] (%)
Dr. Zheng ⁽²⁾	Beneficial owner	88,278,594 Domestic Shares	24.52	[REDACTED]	[REDACTED]
	Interest in controlled corporations	34,729,562 Domestic Shares	9.65	[REDACTED]	
Hangzhou Yantai ⁽²⁾	Beneficial owner	19,031,297 Domestic Shares	5.29	[REDACTED]	[REDACTED]
Hangzhou Hengtai ⁽²⁾	Beneficial owner	15,698,265 Domestic Shares	4.36	[REDACTED]	[REDACTED]
QM32 Limited ⁽³⁾	Beneficial owner	34,071,947 Unlisted Foreign Shares	9.46	[REDACTED]	[REDACTED]
Zhejiang Jiuren Capital Management Co., Ltd. (浙江九仁資本管理有限公司) ⁽⁴⁾	Interest in controlled corporations	28,027,046 Domestic Shares	7.79	[REDACTED]	[REDACTED]
LAV Evergreen (Hong Kong) Co., Limited ⁽⁵⁾	Beneficial owner	25,637,520 Unlisted Foreign Shares	7.12	[REDACTED]	[REDACTED]

SUBSTANTIAL SHAREHOLDERS

Name of Shareholder	Nature of Interest	Number and class of Shares held ⁽¹⁾	Approximate percentage of shareholding in the total share capital of our Company as of the date of this Document (%)	Approximate percentage of shareholding in the relevant class of Shares after the [REDACTED] ⁽¹⁾ (%)	Approximate percentage of shareholding in the total share capital of our Company after the [REDACTED] (%)
Jiangsu Jiequan Lize Health Industry Venture Capital Fund (Limited Partnership) (江蘇走泉禮澤健康產業創業投資基金(有限合夥)) ⁽⁶⁾	Beneficial owner	23,517,076 Domestic Shares	6.53	[REDACTED]	[REDACTED]
Shanghai Liyao Investment Management Co., Ltd. (上海禮曜投資管理有限公司) ⁽⁷⁾	Interest in controlled corporations	21,776,804 Domestic Shares	6.05	[REDACTED]	[REDACTED]
Suzhou Qiming Ronghe Venture Capital Partnership (Limited Partnership) (蘇州啟明融合創業投資合夥企業(有限合夥)) (“Suzhou Qiming”) ⁽⁸⁾	Beneficial owner	16,055,165 Domestic Shares	4.46	[REDACTED]	[REDACTED]
Power SUM Limited ⁽⁹⁾	Beneficial owner	6,958,131 Unlisted Foreign Shares	1.93	[REDACTED]	[REDACTED]
QM153 Limited ⁽¹⁰⁾	Beneficial owner	6,858,828 Unlisted Foreign Shares	1.91	[REDACTED]	[REDACTED]

SUBSTANTIAL SHAREHOLDERS

Notes:

- (1) As the Unlisted Foreign Shares held by QM32 Limited, LAV Evergreen (Hong Kong) Co., Limited, Power SUM Limited and QM153 Limited will not be converted into H Shares upon [REDACTED], the calculation is based on the total number of 286,473,574 Domestic Shares in issue, 73,526,426 Unlisted Foreign Shares in issue and [REDACTED] H Shares in issue immediately after completion of the [REDACTED], and assuming that the [REDACTED] is not exercised.
- (2) Immediately after completion of the [REDACTED] and assuming the [REDACTED] is not exercised, Dr. Zheng beneficially owns 88,278,594 Domestic Shares of our Company. Dr. Zheng, being the sole general partner, controls Hangzhou Yantai and Hangzhou Hengtai, both of which are Employee Incentive Platforms. Therefore, under the SFO, in addition to his direct shareholding, Dr. Zheng is also deemed to be interested in the 19,031,297 Domestic Shares of our Company through Hangzhou Yantai and the 15,698,265 Domestic Shares of our Company through Hangzhou Hengtai, respectively.
- (3) QM32 Limited is held as to 96.99% by Qiming Venture Partners V, L.P., which is managed by Qiming GP V, L.P., which is in turn managed by Qiming Corporate GP V, Ltd. Therefore, Qiming Venture Partners V, L.P., Qiming GP V, L.P. and Qiming Corporate GP V, Ltd. are deemed to be interested in the interest of QM32 Limited under the SFO.
- (4) Zhejiang Jiuren Capital Management Co., Ltd. manages Hangzhou Jiuyao Equity Investment Partnership (Limited Partnership) (杭州九珧股權投資合夥企業(有限合夥)) (“**Hangzhou Jiuyao**”), Hangzhou Jiufu Equity Investment Partnership (Limited Partnership) (杭州九賦股權投資合夥企業(有限合夥)) (“**Hangzhou Jiufu**”), Hangzhou Yunbo Investment Partnership (Limited Partnership) (杭州雲帛投資合夥企業(有限合夥)) (“**Hangzhou Yunbo**”) and Hangzhou Jiuge Equity Investment Partnership (Limited Partnership) (杭州九歌股權投資合夥企業(有限合夥)) (“**Hangzhou Jiuge**”) in its capacity as the fund manager of these funds. Therefore, under SFO, Zhejiang Jiuren Capital Management Co., Ltd. is deemed to be interested in (i) the 10,683,565 Domestic Shares held by Hangzhou Jiuyao, (ii) the 10,683,565 Domestic Shares held by Hangzhou Jiufu, (iii) the 3,804,018 Domestic Shares held by Hangzhou Yunbo and (iv) the 2,855,898 Domestic Shares held by Hangzhou Jiuge.
- (5) LAV Evergreen (Hong Kong) Co., Limited is wholly-owned by Lilly Asia Ventures Fund II, L.P., which is managed by Lilly Asia Ventures Fund GP, L.P., which in turn is managed by LAV Corporate GP, Ltd., a company wholly-owned by Mr. Shi Yi. Therefore, Lilly Asia Ventures Fund II, L.P., Lilly Asia Ventures Fund GP, L.P., LAV Corporate GP, Ltd. and Yi Shi are deemed to be interested in the 25,637,520 Unlisted Foreign Shares held by LAV Evergreen (Hong Kong) Co., Limited under the SFO.
- (6) Jiangsu Jiequan Lize Health Industry Venture Capital Fund (Limited Partnership) is managed by Jiangsu Lize Investment Management Co., Ltd. (江蘇禮澤投資管理有限公司), a company wholly-owned by Mr. Zhu Yong. Therefore, Jiangsu Lize Investment Management Co., Ltd. and Mr. Zhu Yong are deemed to be interested in the 23,517,076 Domestic Shares held by Jiangsu Jiequan Lize Health Industry Venture Capital Fund (Limited Partnership) under the SFO.
- (7) Shanghai Li’an Venture Capital Center (Limited Partnership) and Suzhou Likang Equity Investment Center (Limited Partnership) are both managed by Shanghai Liyi Investment Management Partnership (Limited Partnership) (上海禮頤投資管理合夥企業(有限合夥)), which in turn is managed by Shanghai Liyao Investment Management Co., Ltd. Shanghai Liyao Investment Management Co., Ltd. is wholly-owned by Mr. Chen Fei (陳飛). Therefore, Mr. Chen Fei, Shanghai Liyi Investment Management Partnership (Limited Partnership) and Shanghai Liyao Investment Management Co., Ltd. are deemed to be interested in (i) the 11,983,877 Domestic Shares held by Shanghai Li’an Venture Capital Center (Limited Partnership) and (ii) the 9,792,927 Domestic Shares held by Suzhou Likang Equity Investment Center (Limited Partnership) under the SFO.
- (8) Suzhou Qiming is managed by Suzhou Qicheng Investment Management Partnership (Limited Partnership) (蘇州啟承投資管理合夥企業(有限合夥)), which is in turn managed by Shanghai Qichang Investment Consulting Co., Ltd. (上海啟昌投資諮詢有限公司), a company held as to 50% and 50% by Mr. Hu Xubo, a non-executive Director of our Company, and Ms. Yu Jia (于佳), respectively. Therefore, Suzhou Qicheng Investment Management Partnership (Limited Partnership), Shanghai Qichang Investment Consulting Co., Ltd., Mr. Hu Xubo and Ms. Yu Jia are deemed to be interested in the 16,055,165 Domestic Shares held by Suzhou Qiming under the SFO.

SUBSTANTIAL SHAREHOLDERS

- (9) Power SUM Limited is wholly-owned by Master Summer Limited, which is controlled by CDBI Partners Fund I, L.P., a limited partnership with CDBI Partners GP, Ltd being its general partner and is turn controlled by Mr. Tan Ching (談慶). Therefore, Master Summer Limited, CDBI Partners Fund I, L.P., CDBI Partners GP, Ltd and Mr. Tan Ching are deemed to be interested in the 6,958,131 Unlisted Foreign Shares held by Power SUM Limited under the SFO.
- (10) QM153 Limited is held as to 99.09% by Qiming Venture Partners VII, L.P., whose sole general partner is Qiming GP VII, LLC. Therefore, Qiming Venture Partners VII, L.P. and Qiming GP VII, LLC are deemed to be interested in the 6,858,828 Unlisted Foreign Shares held by QM153 Limited under the SFO.

For details of the substantial shareholders who will be, directly or indirectly, interested in 10% or more of the value of any class of Shares varying rights to vote in all circumstances at general meetings of any member of our Group, see “Appendix VI—Statutory and General Information—Further Information about our Directors, Supervisors, Senior Management and Substantial Shareholders—2. Substantial Shareholders.”

Save as disclosed herein, our Directors are not aware of any persons who will, immediately following completion of the [REDACTED] (assuming the [REDACTED] is not exercised), have interests and/or short positions in Shares or underlying shares which would fall to be disclosed under the provisions of Divisions 2 and 3 of Part XV of the SFO.

SHARE CAPITAL

This section presents certain information regarding our share capital before and upon completion of the [REDACTED].

BEFORE THE [REDACTED]

As of the Latest Practicable Date, the registered capital of our Company was RMB360,000,000, comprising 360,000,000 Shares of nominal value RMB1.0 each, was categorized as follows:

<u>Description of Shares</u>	<u>Number of Shares</u>	<u>Approximate percentage to total share capital</u> (%)
Domestic Shares in issue	286,473,574	79.58
Unlisted Foreign Shares in issue	73,526,426	20.42
Total	360,000,000	100.00

UPON COMPLETION OF THE [REDACTED]

Immediately following completion of the [REDACTED], assuming the [REDACTED] is not exercised, the share capital of our Company will be as follows:

<u>Description of Shares</u>	<u>Number of Shares</u>	<u>Approximate percentage to total share capital</u> (%)
Domestic Shares in issue	286,473,574	[REDACTED]
Unlisted Foreign Shares in issue	73,526,426	[REDACTED]
H Shares to be issued under the [REDACTED]	[REDACTED]	[REDACTED]
Total	[REDACTED]	100.00

SHARE CAPITAL

Immediately following completion of the [REDACTED], assuming the [REDACTED] is fully exercised, the share capital of our Company will be as follows:

Description of Shares	Number of Shares	Approximate percentage to total share capital (%)
Domestic Shares in issue	286,473,574	[REDACTED]
Unlisted Foreign Shares in issue	73,526,426	[REDACTED]
H Shares to be issued under the [REDACTED]	[REDACTED]	[REDACTED]
Total	[REDACTED]	100.00

SHARE CLASSES

Upon completion of the [REDACTED], we would have three classes of Shares, namely Domestic Shares, Unlisted Foreign Shares and H Shares. Domestic Shares, Unlisted Foreign Shares and H Shares are all ordinary Shares in the share capital of our Company. However, apart from certain qualified domestic institutional investors in the PRC, the qualified PRC investors under the Shanghai – Hong Kong Stock Connect or the Shenzhen – Hong Kong Stock Connect and other persons who are entitled to hold our H Shares pursuant to relevant PRC laws and regulations or upon approvals of any competent authorities, H Shares generally cannot be subscribed for by or traded between legal or natural persons of the PRC.

The differences between the three classes of shares and provisions on class rights, the dispatch of notices and financial reports to Shareholders, registration of Shares on different registers of Shareholders, the method of share transfer and appointment of dividend receiving agents are set out in the Articles of Association and summarized in “Appendix V—Summary of Articles of Association.”

Except for the differences above, Domestic Shares, Unlisted Foreign Shares and H Shares will however rank *pari passu* with each other in all other respects and, in particular, will rank equally for all dividends or distributions declared, paid or made after the date of this Document. We must pay all dividends in respect of H Shares in Hong Kong dollars. In addition to cash, dividends may be distributed in the form of Shares. However, the transfer of the unlisted Shares is subject to such restrictions as PRC laws may impose from time to time.

In accordance with the Guidelines on Application for “Full Circulation” of Domestic Unlisted Shares of H-share Companies (《H股公司境內未上市股份申請“全流通”業務指引》) (“**Full Circulation Guidelines**”) published and implemented by the CSRC on November 14, 2019, domestic unlisted shares of H-share companies (including domestic unlisted shares held by domestic shareholders prior to the overseas listing, domestic unlisted shares further issued

SHARE CAPITAL

in the PRC after the overseas listing and unlisted shares held by foreign shareholders) could be listed and traded on the Hong Kong Stock Exchange after application to and approval from the CSRC. The Full Circulation Guidelines are only applicable to domestic companies listed on the Hong Kong Stock Exchange only and not applicable to companies dual listed in the PRC and on the Hong Kong Stock Exchange. Up to the Latest Practicable Date, there are no relevant rules or guidelines from the CSRC providing that A shares holders may convert A shares held by them into H shares for listing and trading on the Hong Kong Stock Exchange.

CONVERSION OF OUR UNLISTED SHARES INTO H SHARES

After the completion of the [REDACTED], we have three classes of ordinary shares, namely Domestic Shares, Unlisted Foreign Shares and H Shares. All our Domestic Shares and our Unlisted Foreign Shares are not listed or traded on any stock exchange. The holders of our Domestic Shares and Unlisted Foreign Shares may convert their Shares into H Shares provided such conversion shall have gone through any requisite internal approval process and complied with the regulations prescribed by the securities regulatory authorities of the State Council and the regulations, requirements and procedures prescribed by the overseas stock exchange(s) and have been approved by the securities regulatory authorities of the State Council, including the CSRC. The listing of such converted Shares on the Hong Kong Stock Exchange will also require the approval of the Hong Kong Stock Exchange.

Based on the procedures for the conversion of our Domestic Shares and our Unlisted Foreign Shares into H Shares as disclosed in this section, we can apply for the [REDACTED] of all or any portion of our Domestic Shares and our Unlisted Foreign Shares on the Hong Kong Stock Exchange as H Shares in advance of any proposed conversion to ensure that the conversion process can be completed promptly upon notice to the Hong Kong Stock Exchange and delivery of Shares for entry on the H Share register. As any [REDACTED] of additional Shares after our [REDACTED] on the Hong Kong Stock Exchange is ordinarily considered by the Hong Kong Stock Exchange to be a purely administrative matter, it will not require such prior application for [REDACTED] at the time of our [REDACTED] in Hong Kong.

No class Shareholder voting is required for the [REDACTED] and trading of the converted Shares on the Hong Kong Stock Exchange. Any application for [REDACTED] of the converted Shares on the Hong Kong Stock Exchange after our [REDACTED] is subject to prior notification by way of announcement to inform Shareholders and the public of such proposed conversion.

After all the requisite approvals have been obtained, the following procedures will need to be completed: the relevant Domestic Shares and Unlisted Foreign Shares will be withdrawn from the Share register and we will re-register such Shares on our H Share register maintained in Hong Kong and instruct the H Share Registrar to issue H Share certificates. Registration on our H Share register will be on the condition that (a) our H Share Registrar lodges with the Hong Kong Stock Exchange a letter confirming the proper entry of the relevant H Shares on the H Share register of members and the due dispatch of H Share certificates and (b) the admission of the H Shares to trade on the Hong Kong Stock Exchange will comply with the

SHARE CAPITAL

Listing Rules and the General Rules of CCASS and the CCASS Operational Procedures in force from time to time. Until the converted Shares are re-registered on our H Share register, such Shares would not be [REDACTED] as H Shares.

See “Risk Factors—Risks Relating to the [REDACTED]—Future sales or perceived sales of a substantial number of our H Shares in the public market following the [REDACTED] could materially and adversely affect the price of our H Shares and our ability to raise additional capital in the future, and may result in dilution of your shareholding.”

So far as we are aware, none of our Shareholders currently proposes to convert any of their Domestic Shares or Unlisted Foreign Shares into H Shares.

TRANSFER OF SHARES ISSUED PRIOR TO THE [REDACTED]

Pursuant to the PRC Company Law, our Shares issued prior to the [REDACTED] shall not be transferred within one year from the [REDACTED].

For details of the lock-up undertaking given by the Single Largest Group of Shareholders pursuant to Rule 10.07 of the Listing Rules, see “[REDACTED]”.

REGISTRATION OF SHARES NOT LISTED ON AN OVERSEAS STOCK EXCHANGE

According to the Notice of Centralized Registration and Deposit of Non-overseas Listed Shares of Companies Listed on an Overseas Stock Exchange (《關於境外上市公司非境外上市股份集中登記存管有關事宜的通知》) issued by the CSRC, our Company is required to register and deposit our Shares that are not listed on the overseas stock exchange with the China Securities Depository and Clearing Corporation Limited within 15 business days upon the [REDACTED] and provide a written report to the CSRC regarding the centralized registration and deposit of our Shares that are not [REDACTED] on the overseas stock exchange as well as the [REDACTED] and [REDACTED] of our H Shares.

EMPLOYEE INCENTIVE SCHEMES

We established two Employee Incentive Platforms, namely Hangzhou Yantai and Hangzhou Hengtai. The two Employee Incentive Platforms, in aggregate, held 34,729,562 Domestic Shares of the Company as of the Latest Practicable Date. For the details of the Employee Incentive Platforms, see “Appendix VI—Statutory and General Information—Further Information About Our Directors, Supervisors, Senior Management and Substantial Shareholders—5. Employee Incentive Schemes.”

FINANCIAL INFORMATION

You should read the following discussion and analysis in conjunction with our consolidated financial statements and the accompanying notes included in the Accountants’ Report set forth in Appendix I to this Document. Our consolidated financial statements have been prepared in accordance with HKFRSs, which may differ in material aspects from generally accepted accounting principles in other jurisdictions. You should read the entire accountants’ report and not merely rely on the information contained in this section.

The following discussion and analysis contain forward-looking statements that reflect the current views with respect to future events and financial performance. These statements are based on assumptions and analysis made by us in light of our experience and perception of historical trends, current conditions and expected future developments, as well as other factors that we believe are appropriate under the circumstances. However, whether the actual outcome and developments will meet our expectations and predictions depends on a number of risks and uncertainties over which we do not have control. For details, see “Forward-looking Statements” and “Risk Factors.”

For the purpose of this section, unless the context otherwise requires, references to 2019 and 2020 refer to our financial year ended December 31 of such year. Unless the context otherwise requires, financial information described in this section is described on a consolidated basis.

OVERVIEW

We are a pioneer in the diabetes management medical devices industry that innovates and integrates the treatment and monitoring of diabetes to reshape the diabetes management paradigm in China and globally. We are the only company that has commercialized both patch insulin delivery system and calibration-free CGMS in the world, according to the CIC Report. We believe that our comprehensive and market-leading product portfolio, our advanced positioning in the development of closed loop solutions, our deeply integrated treatment and monitoring platform created through robust R&D, manufacturing and commercialization capabilities, together with our visionary management team, significantly differentiate us from our peers. We are dedicated to helping people with diabetes lead healthier lives. Our long-term mission is to become the global leader in diabetes management.

BASIS OF PREPARATION

The consolidated financial information of our Group has been prepared in accordance with Hong Kong Financial Reporting Standards (“**HKFRSs**”) (which include all Hong Kong Financial Reporting Standards, Hong Kong Accounting Standards (“**HKASs**”) and Interpretations) issued by the HKICPA and accounting principles generally accepted in Hong Kong. All HKFRSs effective for the accounting period commencing from January 1, 2020, as well as the amendment to HKFRS 16 *Covid-19-Related Rent Concessions*, together with the

FINANCIAL INFORMATION

relevant transitional provisions, have been consistently applied by the Group in the preparation of the consolidated financial information of our Group throughout the reporting period. The consolidated financial information of our Group has been prepared under the historical cost convention, except for financial assets measured at fair value through profit or loss.

KEY FACTORS AFFECTING OUR RESULTS OF OPERATIONS

Our results of operations have been, and are expected to continue to be, affected by a number of factors, many of which may be beyond our control. A discussion of the key factors is set out below.

Growth of the Diabetes Management Medical Devices Market in China and Globally

We believe that our financial performance and future growth are dependent on the overall growth of the diabetes management medical devices market in China and globally. According to the CIC Report, diabetes is one of the most prevalent chronic diseases in the world with a large patient population and huge unmet clinical needs. The global prevalence of diabetes was 486.9 million people in 2019 and is expected to reach 607.6 million people in 2030, according to the CIC Report. According to IDF, China is the country with the highest number of diabetes patients in 2019. The prevalence of diabetes in China was 118.8 million people in 2019, and is expected to reach 143.2 million people in 2030, according to the CIC Report.

The increasing prevalence of diabetes worldwide, people’s increasing health awareness and governmental favorable policies have been driving and will continue to drive the growth of the diabetes management medical devices market. The market size of global diabetes management medical devices market increased from US\$33.2 billion in 2015 to US\$47.8 billion in 2020, at a CAGR of 7.6%, and is expected to further increase to US\$111.1 billion in 2030, at a CAGR of 8.8% from 2020 to 2030, according to the CIC Report. The market size of the diabetes management medical devices market in China increased from US\$0.9 billion in 2015 to US\$2.4 billion in 2020, at a CAGR of 21.6%, and is expected to further increase to US\$9.5 billion in 2030, at a CAGR of 14.7% from 2020 to 2030, according to the CIC Report. See “Industry Overview.”

We are the only company that has commercialized both patch insulin delivery system and calibration-free CGMS in the world, according to the CIC Report. Our Core Product, Equil, is the second commercialized semi-disposable patch insulin pump globally and the first and the only domestically developed patch insulin pump approved in China and the EU. We believe that by leveraging our position as a pioneer in the diabetes management medical devices industry, we are well-positioned to capture the expected growth of the market through our comprehensive and market-leading product portfolio, and we expect our results of operation and financial performance to improve in the future.

FINANCIAL INFORMATION

Our Ability to Increase Sales Volume of Equil

The sales volume of our current products will affect our results of operation in the next several years. Equil is the second commercialized semi-disposable insulin pump globally, and the first and only domestically developed patch insulin pump system approved in China and the EU. Following the launch of Equil in 2018, we have seen a rapid revenue growth. Revenue generated from Equil accounted for 47.6% and 46.2% of our total revenue in 2019 and 2020, respectively. We expect that sales of Equil will continue to be a significant driving factor for our total revenue growth in the near term. We intend to increase sales of Equil through continuing marketing efforts of our in-house sales and marketing team and the expansion of our distribution network in China and globally.

As of the Latest Practicable Date, Equil had been sold or distributed into 747 hospitals in China. We plan to increase sales efforts to deepen penetration in hospitals to which we currently sell Equil. We expect the demand for Equil in these hospitals will continue to grow as the demand for patch insulin pumps increases in the near future. We also plan to expand into new hospitals and increase the application of patch insulin pump by more patients and healthcare professionals in China by providing systematic trainings and continuing our sponsorship and participation in diabetes conferences.

Development and Commercialization of Our Product Candidate

Our ability to develop and commercialize pipeline products and diversify our product portfolio significantly affects our results of operations. Our market-driven R&D activities focus on product candidates that address rapidly growing clinical needs for diabetes management medical devices, including patch insulin pump systems, CGMS and closed loop solutions, in particular, artificial pancreas, in China and globally.

Targeting the insulin pump market, besides the commercialized Equil, we are also in the process of developing the second-generation patch insulin pump system with market-oriented features. Addressing the CGMS market, we have received CE marking for AiDEX G7 in Europe, and it has been certified by the NMPA in May 2020 to be eligible for the Special Approval Procedures of Innovative Medical Devices promulgated by the NMPA. We are also in the process of developing AiDEX X to complement AiDEX G7 and cater to non-intensive diabetics, pre-diabetics, and health-aware non-diabetic users. As of the Latest Practicable Date, we had completed the feasibility analysis of our second-generation patch insulin pump system and AiDEX X. We expect to complete the relevant registrational clinical trial and submit the relevant registration application to the NMPA for our second-generation patch insulin pump system and AiDEX X in the first half of 2023 and the second half of 2022, respectively. Furthermore, we will continue developing our closed loop solutions, in particular, artificial pancreas. We will equip our second-generation patch insulin pump system with control algorithms, which, together with our CGMS, is expected to form the bedrock of our closed loop artificial pancreas. We are currently testing our proprietary control algorithms on AiDEX G7 and Equil, and we aim to initiate the registrational clinical trial for our closed loop artificial pancreas in the first half of 2022 in China, and a registrational clinical trial in the U.S. is also

FINANCIAL INFORMATION

under plan. We also continue to enrich our IVD device portfolio and invest in the development of glucose, keton, uric acid monitoring system and multifunctional POCT device. In 2019 and 2020, our total R&D expenses amounted to RMB50.1 million and RMB82.0 million, accounting for 96.5% and 108.9% of our total revenue, respectively.

Our results of operations also depend on our ability to successfully commercialize our product candidates upon approval. We plan to utilize our commercialization capabilities and efficiencies to expand our global footprint and ramp up our market shares in major markets. With increasing diabetes community’s awareness of the clinical benefits of our products, we believe that we can effectively promote our new products. Our ability to successfully develop and commercialize new diabetes management medical devices in the manner we contemplate and to achieve the sales we expect is subject to a number of risks, many of which are beyond our control. For further details of the risks relating to the development and commercialization of new products, see “Risk Factors—Risks Relating to Our Business—Risks Relating to the Development of Our Product Candidates.”

Changes in Pricing of Our Products

Changes in our products’ selling prices constitute another important factor that affects our operating results. In line with market practice, we sell a significant portion of our products to distributors who resell our products to hospitals, pharmacies or individual customers. In addition, we also sell a portion of our products directly to large retail pharmacies and individual customers. Our domestic distributors, or we in our direct sales to customers, negotiate and set retail prices directly with hospitals and other clients. Our domestic distributors shall not set any retail prices that are lower than the suggested resale prices set in the relevant distributorship agreement without our prior consent. The retail price of our products sold by our overseas distributors may vary from country to country, subject to factors such as prices of competing products and local insurance coverage. For details, see “Business—Sales and Marketing—Pricing.” Hospitals, among others, may gain more bargaining power depending on the availability of alternative products, demands of patients and the preference of physicians. If hospitals lower retail prices of our products and therefore reduce the profitability of our distributors, our distributors may have less incentive to purchase and promote our products, and we may need to lower the order price we set for our distributors. Moreover, we may also face pricing pressure from competing products or new launch of pipeline products by our competitors.

FINANCIAL INFORMATION

Our Ability to Improve Operating Efficiency

Our profitability has benefited from our effective control of cost of sales and ability to improve operating efficiency. Our cost of sales primarily includes material costs, staff costs and other costs. We have devoted efforts to control our cost of sales. Our cost of sales as a percentage of revenue was 53.6% and 51.5% in 2019 and 2020, respectively. As our production volume and revenue grow, our cost of sales as a percentage of revenue may decrease.

Similarly, our ability to efficiently control our operating expenses will also impact our profitability. Our operating expenses include R&D expenses, selling and distribution expenses, administrative expenses and other expenses.

Since our inception, we have focused our resources on R&D activities, including conducting clinical trials and activities related to regulatory filing for our product candidates. In 2019 and 2020, our R&D expenses accounted for 96.5% and 108.9% of our revenue, respectively. Our R&D expenses mainly consist of equity-settled share award expense, staff costs, experiment and trial fees, raw material costs, among others. We expect to incur significant R&D expenses for the foreseeable future as our development programs progress and we continue to support the clinical trials of our product candidates.

Selling and distribution expenses are another major component of our operating expenses, accounting for 52.1% and 73.1% of our revenue in 2019 and 2020, respectively. Our selling and distribution expenses mainly consist of equity-settled share award expense, staff costs, marketing and promotion costs, among others. We expect our selling and distribution expense to increase in future periods to support the expanded marketing of our existing product and the commercialization of our product candidates once approved.

Funding for Our Operations

In 2019 and 2020, we funded our operations primarily through equity financing. Going forward, with the marketing of our current products and the successful commercialization of our product candidates, we expect to fund our operations in part with revenue generated from sales of our products. However, with the continuing expansion of our business and development of product candidates, we may require further funding through public or private equity offerings, debt financing and other sources. Any changes in our ability to fund our operations will affect our cash flow and results of operation.

FINANCIAL INFORMATION

SIGNIFICANT ACCOUNTING POLICIES, JUDGMENTS AND ESTIMATES

We have identified certain accounting policies that are significant to the preparation of our consolidated financial statements. Some of our accounting policies involve subjective assumptions and estimates, as well as complex judgments relating to accounting items. Estimates and judgments are continually re-evaluated and are based on historical experience and other factors, including industry practices and expectations of future events that we believe to be reasonable under the circumstances. We have not changed our assumptions or estimates in the past and have not noticed any material errors regarding our assumptions or estimates. Under current circumstances, we do not expect that our assumptions or estimates are likely to change significantly in the future. When reviewing our consolidated financial statements, you should consider (i) our critical accounting policies, (ii) the judgments and other uncertainties affecting the application of such policies, and (iii) the sensitivity of reported results to changes in conditions and assumptions.

Significant Accounting Policies

Revenue Recognition

Revenue from contracts with customers

Revenue from contracts with customers is recognized when control of goods or services is transferred to the customers at an amount that reflects the consideration to which we expect to be entitled in exchange for those goods or services.

When the contract contains a financing component which provides the customer with a significant benefit of financing the transfer of goods or services to the customer for more than one year, revenue is measured at the present value of the amount receivable, discounted using the discount rate that would be reflected in a separate financing transaction between us and the customer at contract inception. When the contract contains a financing component which provides us with a significant financial benefit for more than one year, revenue recognized under the contract includes the interest expense accreted on the contract liability under the effective interest method. For a contract where the period between the payment by the customer and the transfer of the promised goods or services is one year or less, the transaction price is not adjusted for the effects of a significant financing component, using the practical expedient in HKFRS 15.

FINANCIAL INFORMATION

Sale of medical devices and consumables

Revenue from the sale of medical devices and consumables is recognized at the point in time when control of the asset is transferred to the customer, generally on acceptance of the products.

Fair value measurement

We measure certain financial instruments at fair value at the end of each of the reporting period. Fair value is the price that would be received to sell an asset or paid to transfer a liability in an orderly transaction between market participants at the measurement date. The fair value measurement is based on the presumption that the transaction to sell the asset or transfer the liability takes place either in the principal market for the asset or liability, or in the absence of a principal market, in the most advantageous market for the asset or liability. The principal or the most advantageous market must be accessible by us. The fair value of an asset or a liability is measured using the assumptions that market participants would use when pricing the asset or liability, assuming that market participants act in their economic best interest.

A fair value measurement of a non-financial asset takes into account a market participant’s ability to generate economic benefits by using the asset in its highest and best use or by selling it to another market participant that would use the asset in its highest and best use.

We use valuation techniques that are appropriate in the circumstances and for which sufficient data are available to measure fair value, maximizing the use of relevant observable inputs and minimizing the use of unobservable inputs.

All assets and liabilities for which fair value is measured or disclosed in the consolidated financial information of our Group are categorized within the fair value hierarchy, described as follows, based on the lowest level input that is significant to the fair value measurement as a whole:

Level 1 – based on quoted prices (unadjusted) in active markets for identical assets or liabilities

Level 2 – based on valuation techniques for which the lowest level input that is significant to the fair value measurement is observable, either directly or indirectly

Level 3 – based on valuation techniques for which the lowest level input that is significant to the fair value measurement is unobservable

For assets and liabilities that are recognized in the consolidated financial information of our Group on a recurring basis, we determine whether transfers have occurred between levels in the hierarchy by reassessing categorization (based on the lowest level input that is significant to the fair value measurement as a whole) at the end of each of the reporting periods.

FINANCIAL INFORMATION

Property, plant and equipment and depreciation

Property, plant and equipment, are stated at cost less accumulated depreciation and any impairment losses. The cost of an item of property, plant and equipment comprises its purchase price and any directly attributable costs of bringing the asset to its working condition and location for its intended use.

Expenditure incurred after items of property, plant and equipment have been put into operation, such as repairs and maintenance, is normally charged to the statement of profit or loss in the period in which it is incurred. In situations where the recognition criteria are satisfied, the expenditure for a major inspection is capitalized in the carrying amount of the asset as a replacement. Where significant parts of property, plant and equipment are required to be replaced at intervals, we recognize such parts as individual assets with specific useful lives and depreciates them accordingly.

Depreciation is calculated on the straight-line basis to write off the cost of each item of property, plant and equipment to its residual value over its estimated useful life. The estimated useful lives of property, plant and equipment are as follows:

Buildings	10 to 20 years
Machinery and equipment	3 to 10 years
Computer and office equipment	3 to 5 years
Motor vehicles	5 years

Where parts of an item of property, plant and equipment have different useful lives, the cost of that item is allocated on a reasonable basis among the parts and each part is depreciated separately. Residual values, useful lives and the depreciation methods are reviewed, and adjusted if appropriate, at least at each financial year end.

An item of property, plant and equipment including any significant part initially recognized is derecognized upon disposal or when no future economic benefits are expected from its use or disposal. Any gain or loss on disposal or retirement recognized in the statement of profit or loss in the year the asset is derecognized is the difference between the net sales proceeds and the carrying amount of the relevant asset.

Construction in progress represents a building under construction, and plant and machinery, furniture and fixtures under installation, which is stated at cost less any impairment losses, and is not depreciated. Cost comprises the direct costs of construction during the period of construction. Construction in progress is reclassified to the appropriate category of property, plant and equipment when completed and ready for use.

FINANCIAL INFORMATION

Intangible assets

Intangible assets acquired separately are measured on initial recognition at cost. The useful lives of intangible assets are assessed to be either finite or indefinite. Intangible assets with finite lives are subsequently amortized over the useful economic life and assessed for impairment whenever there is an indication that the intangible asset may be impaired. The amortization period and the amortization method for an intangible asset with a finite useful life are reviewed at least at each financial year end.

Intellectual property

Purchased intellectual property is stated at cost less any impairment losses and is amortized on the straight-line basis over its estimated useful life of 4 to 20 years, which is determined by considering the typical product life cycles and the technical obsolescence of the intellectual property.

Software

Purchased software is stated at cost less any impairment losses and amortized on the straight-line basis over its estimated useful life of 3 to 5 years.

Research and development cost

All research costs are charged to the statement of profit or loss as incurred.

Expenditure incurred on projects to develop new products is capitalized and deferred only when we can demonstrate the technical feasibility of completing the intangible asset so that it will be available for use or sale, our intention to complete and our ability to use or sell the asset, how the asset will generate future economic benefits, the availability of resources to complete the project and the ability to measure reliably the expenditure during the development. Product development expenditure which does not meet these criteria is expensed when incurred.

Inventories

Inventories are stated at the lower of cost and net realizable value. Cost is determined on the weighted average basis and, in the case of work in progress and finished goods, comprises direct materials, direct labor and an appropriate proportion of overheads. Net realizable value is based on estimated selling prices less any estimated costs to be incurred to completion and disposal.

FINANCIAL INFORMATION

Government grants

Government grants are recognized at their fair value where there is reasonable assurance that the grant will be received and all attaching conditions will be complied with. When the grant relates to an expense item, it is recognized as income on a systematic basis over the periods that the costs, for which it is intended to compensate, are expensed.

Where the grant relates to an asset, the fair value is credited to a deferred income account and is released to the statement of profit or loss over the expected useful life of the relevant asset by equal annual instalments or deducted from the carrying amount of the asset and released to the statement of profit or loss by way of a reduced depreciation charge.

Share-based payments

Our Company operate a share award plan for the purpose of providing incentives and rewards to eligible participants who contribute to the success of our operations. Our employees (including directors) receive remuneration in the form of share-based payments, whereby employees render services as consideration for equity instruments.

Significant Accounting Estimates

Provision for expected credit losses of trade receivables

We use a provision matrix to calculate expected credit losses (“ECLs”) for trade receivables. The provision rates are based on ageing for groupings of various customer segments that have similar loss patterns (i.e., by customer type).

The provision matrix is initially based on the historical observed default rates from listed companies in the same sector. We calibrate the matrix to adjust the historical credit loss experience with forward-looking information. For instance, if forecast economic conditions (i.e., gross domestic product) are expected to deteriorate over the next year which can lead to an increased number of defaults in the medical industry sector, the historical default rates are adjusted. At each reporting date, the historical observed default rates are updated and changes in the forward-looking estimates are analysed.

The assessment of the correlation between historical observed default rates, forecast economic conditions and ECLs is a significant estimate. The amount of ECLs is sensitive to changes in circumstances and of forecast economic conditions. Our historical credit loss experience and forecast of economic conditions may also not be representative of customers’ actual default in the future.

FINANCIAL INFORMATION

Useful lives of intangible assets

Our finite life intangible assets primarily represent patents. These intangible assets are amortized on a straight-line basis over their useful economic lives, which are estimated to be the patent life. Additional amortization is recognized if the estimated useful lives of patents are different from the previous estimation. Useful lives are reviewed at the end of each of the relevant years/periods based on changes in circumstances.

Impairment of non-financial assets

We assess whether there are any indicators of impairment for all non-financial assets (including the right-of-use assets) at the end of each of the relevant years/periods. Other non-financial assets are tested for impairment when there are indicators that the carrying amounts may not be recoverable. An impairment exists when the carrying value of an asset or a cash-generating unit exceeds its recoverable amount, which is the higher of its fair value less costs of disposal and its value in use. The calculation of the fair value less costs of disposal is based on available data from binding sales transactions in an arm’s length transaction of similar assets or observable market prices less incremental costs for disposing of the asset. When value in use calculations are undertaken, management must estimate the expected future cash flows from the asset or cash-generating unit and choose a suitable discount rate in order to calculate the present value of those cash flows.

DISCUSSION OF CERTAIN ITEMS IN THE CONSOLIDATED STATEMENTS OF PROFIT OR LOSS

The following table sets forth selected items of our consolidated statements of profit or loss in absolute amount and as percentage of our revenue for the years indicated, which have been extracted from the Accountants’ Report set out in Appendix I to this Document.

	For the year ended December 31,			
	2019		2020	
	<i>RMB’000</i>	%	<i>RMB’000</i>	%
Revenue	51,863	100.0	75,277	100.0
Cost of sales	(27,780)	(53.6)	(38,733)	(51.5)
Gross profit	24,083	46.4	36,544	48.5
Other income and gains	8,716	16.8	27,663	36.7
Selling and distribution expenses ⁽¹⁾	(27,003)	(52.1)	(55,059)	(73.1)
Administrative expenses ⁽¹⁾	(33,615)	(64.8)	(45,758)	(60.8)
Impairment losses on financial assets, net	(423)	(0.8)	(188)	(0.2)
Research and development expenses ⁽¹⁾	(50,060)	(96.5)	(82,009)	(108.9)

FINANCIAL INFORMATION

	For the year ended December 31,			
	2019		2020	
	<i>RMB'000</i>	%	<i>RMB'000</i>	%
Other expenses	(1)	(0.0)	(2,135)	(2.8)
Finance costs	(311)	(0.6)	(308)	(0.4)
Loss before tax	(78,614)	(151.6)	(121,250)	(161.1)
Income tax expense	–	–	–	–
Loss for the year	(78,614)	(151.6)	(121,250)	(161.1)

Note:

- (1) We incurred equity-settled share award expenses of RMB57.6 million and RMB111.2 million for the years ended December 31, 2019 and 2020, respectively, which were allocated into selling and distribution expenses, administrative expenses and research and development expenses for the respective years.

Revenue

During the Track Record Period, all of our revenue was generated from the sales of medical devices, including Equil, BGMS and others. The following table sets forth a breakdown of our revenue by product in absolute amount and as percentage of our total revenue for the years indicated.

	For the year ended December 31,			
	2019		2020	
	<i>RMB'000</i>	%	<i>RMB'000</i>	%
Equil	24,684	47.6	34,742	46.2
BGMS	26,989	52.0	39,290	52.2
Others	190	0.4	1,245	1.6
Total	51,863	100.0	75,277	100.0

FINANCIAL INFORMATION

Cost of Sales

Our cost of sales primarily consists of material costs, staff costs and others.

The following table sets forth a breakdown of our cost of sales by nature in absolute amount and as percentage of our total cost of sales for the years indicated.

	For the year ended December 31,			
	2019		2020	
	<i>RMB'000</i>	%	<i>RMB'000</i>	%
Material costs	21,572	77.7	30,244	78.1
Staff costs	5,551	20.0	7,385	19.1
Others	657	2.3	1,104	2.8
Total	27,780	100.0	38,733	100.0

The following table sets forth a breakdown of our cost of sales by product in absolute amount and as percentage of our total cost of sales for the years indicated.

	For the year ended December 31,			
	2019		2020	
	<i>RMB'000</i>	%	<i>RMB'000</i>	%
Equil	6,966	25.1	9,567	24.7
BGMS	20,678	74.4	28,527	73.7
Others	136	0.5	639	1.6
Total	27,780	100.0	38,733	100.0

Gross Profit and Gross Margin

Our gross profit represents our revenue less our cost of sales. Our gross margin represents our gross profit as a percentage of our revenue. In 2019 and 2020, our gross profit was RMB24.1 million and RMB36.5 million, respectively. In 2019 and 2020, our gross margin was 46.4% and 48.5%, respectively.

FINANCIAL INFORMATION

The table below sets forth a breakdown of our gross profit and gross margin by product for the years indicated.

	For the year ended December 31,			
	2019		2020	
	Gross profit	Gross margin	Gross profit	Gross margin
	<i>RMB'000</i>	%	<i>RMB'000</i>	%
Equil	17,718	71.8	25,175	72.5
BGMS	6,311	23.4	10,763	27.4
Others	54	28.4	606	48.7
Total	24,083		36,544	

Other Income and Gains

Our other income and gains consist of (i) investment income from financial assets at fair value through profit or loss, which is primarily related to investment gain from investments in financial products issued by commercial banks and other financial institutions; (ii) government grants, primarily including subsidies received from the local governments to support our R&D activities and business operations; (iii) bank interest income; (iv) foreign exchange gains, net; (v) gain on disposal of property, plant and equipment and (vi) others. The following table sets forth a breakdown of our other income and gains in absolute amount and as percentage of our other income and gains for the years indicated.

	For the year ended December 31,			
	2019		2020	
	<i>RMB'000</i>	%	<i>RMB'000</i>	%
	<i>RMB'000</i>	%	<i>RMB'000</i>	%
Investment income from financial assets at fair value through profit or loss ("FVTPL")	5,374	61.7	5,768	20.9
Government grants	2,246	25.8	19,243	69.6
Bank interest income	848	9.7	2,376	8.6
Foreign exchange gains, net	186	2.1	–	–
Gain on disposal of property, plant and equipment	62	0.7	227	0.8
Others	–	–	49	0.1
Total	8,716	100.0	27,663	100.0

FINANCIAL INFORMATION

Selling and Distribution Expenses

Our selling and distribution expenses primarily consist of (i) equity-settled share award expense in relation to share awards we granted to our sales and marketing personnel; (ii) sales and marketing staff costs, primarily including salaries and benefits for our in-house sales and marketing staff; (iii) marketing and promotion costs, which primarily consist of the expenses associated with our marketing and promotion activities, including marketing activities for our newly-launched products, organization and participation in different levels of educational symposia, conferences, seminars, among others; (iv) travelling and entertainment expense; (v) transportation expense; (vi) office expense; and (vii) other expenses that are directly related to our marketing and promotion activities. The following table sets forth a breakdown of our selling and distribution expenses in absolute amount and as percentage of our total selling and distribution expenses for the years indicated.

	For the year ended December 31,			
	2019		2020	
	<i>RMB'000</i>	%	<i>RMB'000</i>	%
Equity-settled share award expense	138	0.5	20,367	37.0
Staff costs	15,601	57.8	19,982	36.3
Marketing and promotion costs	4,734	17.5	8,059	14.6
Travelling and entertainment expense	4,135	15.3	2,698	4.9
Transportation expense	963	3.6	2,160	3.9
Office expense	286	1.1	267	0.5
Others	1,146	4.2	1,526	2.8
Total	27,003	100.0	55,059	100.0

Administrative Expenses

Our administrative expenses primarily consist of (i) equity-settled share award expense in relation to share awards we granted to our management and administrative staff; (ii) administrative staff costs, which primarily consist of compensation for management and administrative staff; (iii) office expense; (iv) depreciation and amortization relating to our property and plant for office use; (v) professional service fees associated with our equity raising activities; and (vi) other administrative expenses. The following table sets forth a breakdown of our administrative expenses in absolute amount and as percentage of our total administrative expenses for the years indicated.

FINANCIAL INFORMATION

	For the year ended December 31,			
	2019		2020	
	<i>RMB'000</i>	%	<i>RMB'000</i>	%
Equity-settled share award expense	28,482	84.7	33,556	73.3
Staff costs	2,873	8.5	4,828	10.6
Office expense	1,033	3.1	1,397	3.1
Depreciation and amortization	388	1.2	1,409	3.1
Professional services fees	113	0.3	2,796	6.1
Others	726	2.2	1,772	3.8
Total	33,615	100.0	45,758	100.0

Research and Development Expenses

Our research and development expenses comprise costs incurred in performing research and development activities, including (i) equity-settled share award expense in relation to share awards we granted to our R&D staff; (ii) R&D staff costs, which primarily consist of salaries and benefits for our R&D staff; (iii) depreciation and amortization, which are primarily associated with R&D related equipment; (iv) service fees, which primarily consist of expenses incurred for conducting clinical trials, including payment to CROs and SMOs in relation to our clinical trials; (v) raw material costs, which primarily include expenses on raw materials used for developing our product candidates; (vi) travelling and entertainment expense; and (vii) other expenses incurred for the purposes of R&D. The following table sets forth a breakdown of our research and development expenses in absolute amount and as percentage of our total research and development expenses for the years indicated.

	For the year ended December 31,			
	2019		2020	
	<i>RMB'000</i>	%	<i>RMB'000</i>	%
Equity-settled share award expense	28,944	57.9	57,253	69.8
Staff costs	10,431	20.8	11,800	14.5
Depreciation and amortization	2,841	5.7	3,304	4.0
Service fees	4,060	8.1	4,049	4.9
Raw material costs	1,917	3.8	2,218	2.7
Travelling and entertainment expense	592	1.2	637	0.8
Others	1,275	2.5	2,748	3.3
Total	50,060	100.0	82,009	100.0

FINANCIAL INFORMATION

Income Tax Expenses

We did not incur any income tax expenses during the Track Record Period. Pursuant to the EIT Law and the relevant regulations, our subsidiary which operates in China is subject to corporate income tax at a rate of 25% on the taxable income derived in China. Our Company has been qualified as a high and new technology enterprise, and accordingly was entitled to the preferential income tax rate of 15% in 2019 and 2020.

PERIOD TO PERIOD COMPARISON OF RESULTS OF OPERATIONS

Year Ended December 31, 2020 Compared to Year Ended December 31, 2019

Revenue

Our revenue increased by RMB23.4 million, or 45.1%, from RMB51.9 million in 2019 to RMB75.3 million in 2020. The increase was primarily attributable to an increase in revenue generated from sales of Equil, our Core Product, and an increase in revenue generated from sales of our BGMS.

- ***Equil***. Our revenue generated from Equil increased by RMB10.0 million, from RMB24.7 million in 2019 to RMB34.7 million in 2020. In 2017, Equil received marketing approval for adult use from the NMPA. Equil is the first and the only domestically developed patch insulin pump approved in China and the EU. We expect the sales of Equil to grow as we ramp up the market share.
- ***BGMS***. Our revenue generated from BGMS increased by RMB12.3 million, or 45.6%, from RMB27.0 million in 2019 to RMB39.3 million in 2020. The increase was primarily attributable to our sales growth.

Cost of Sales

Our cost of sales increased by RMB10.9 million, or 39.4%, from RMB27.8 million in 2019 to RMB38.7 million in 2020. The increase was primarily as a result of the increase in material costs of RMB8.7 million due to our increased sales volumes, as well as an increase of RMB1.8 million in staff costs as a result of an increase in the number of production-related staff as well as increased compensation levels.

Gross Profit and Gross Margin

As a result of the factors described above, our gross profit increased by RMB12.5 million, or 51.7%, from RMB24.1 million in 2019 to RMB36.5 million in 2020. Our gross margin increased from 46.4% in 2019 to 48.5% in 2020.

FINANCIAL INFORMATION

Other Income and Gains

Our other income and gains increased significantly from RMB8.7 million in 2019 to RMB27.7 million in 2020. The increase was primarily attributable to a government grant of RMB17.0 million in 2020.

Selling and Distribution Expenses

Our selling and distribution expenses increased by RMB28.1 million, or 103.9%, from RMB27.0 million in 2019 to RMB55.1 million in 2020. The increase was primarily attributable to (i) an increase of RMB20.2 million in equity-settled share award expenses for share awards granted to our sales and marketing personnel and (ii) an increase of RMB4.4 million in staff costs due to an increase in sales and marketing headcount to support our increasing sales and marketing activities.

Administrative Expenses

Our administrative expenses increased significantly from RMB33.6 million in 2019 to RMB45.8 million in 2020. The increase was primarily attributable to an increase of RMB5.1 million in equity-settled share award expenses for share awards granted to our management and administrative staff.

Impairment Losses on Financial Assets, Net

Our impairment losses on financial assets, net, were RMB423 thousand and RMB188 thousand in 2019 and 2020, respectively. Our impairment losses on financial assets, net, represent impairment of trade receivables.

Research and Development Expenses

Our research and development expenses increased by RMB31.9 million, or 63.8%, from RMB50.1 million in 2019 to RMB82.0 million in 2020. The increase was primarily attributable to an increase of RMB28.3 million in equity-settled share award expenses for share awards granted to our R&D staff as part of our ongoing talent strategy.

Other Expenses

We recorded other expenses of RMB1 thousand and RMB2.1 million in 2019 and 2020, respectively, which were primarily related to loss on foreign exchanges as a result of foreign exchange fluctuation.

FINANCIAL INFORMATION

Finance Costs

Our finance costs remained relatively stable at RMB0.3 million in 2019 and 2020. Our financial costs mainly consist of the interest on bank loans we borrowed from commercial banks.

Income Tax Expense

Our income tax expense remained at nil during the Track Record Period.

Loss for the year

As a result of the foregoing, we incurred a loss of RMB78.6 million and RMB121.3 million in 2019 and 2020, respectively.

DISCUSSION OF CERTAIN KEY ITEMS OF CONSOLIDATED STATEMENTS OF FINANCIAL POSITION

The table below sets forth selected items from our consolidated statements of financial position as of the dates indicated, which have been extracted from the Accountants’ Report set out in Appendix I to this Document.

	As of December 31,	
	2019	2020
	<i>RMB’000</i>	<i>RMB’000</i>
Total non-current assets	69,194	88,998
Total current assets	195,549	688,276
Total assets	264,743	777,274
Total current liabilities	47,953	48,757
Net current assets	147,596	639,519
Total non-current liabilities	–	–
Total liabilities	47,953	48,757
Net assets	216,790	728,517
Share capital	–	360,000
Paid-in capital	74,402	–
Reserves	142,388	368,517
Total equity	216,790	728,517

FINANCIAL INFORMATION

NET CURRENT ASSETS

The following table sets forth our current assets and current liabilities as of the dates indicated.

	As of December 31,		As of March 31,
	2019	2020	2021
	<i>RMB'000</i>	<i>RMB'000</i>	<i>RMB'000</i> <i>(unaudited)</i>
Current assets			
Inventories	8,638	18,423	17,965
Trade and bills receivables	7,386	10,359	16,960
Prepayments, other receivables and other assets	4,980	4,502	7,299
Due from a director	9,622	–	–
Financial assets at FVTPL	123,495	105,192	15,195
Cash and cash equivalents	41,428	549,800	630,673
Total current assets	195,549	688,276	688,092
Current liabilities			
Trade payables	5,248	7,599	6,077
Lease liabilities	–	126	127
Other payables and accruals	27,411	31,314	26,991
Interest-bearing bank borrowings-current	10,012	–	–
Contract liabilities	5,282	9,718	7,201
Total current liabilities	47,953	48,757	40,396
Net current assets	147,596	639,519	647,696

We had net current assets of RMB647.7 million as of March 31, 2021, compared to net current assets of RMB639.5 million as of December 31, 2020. The change was primarily due to a decrease in total current liabilities of RMB8.4 million, mainly as a result of a decrease in other payables and accruals of RMB4.3 million.

We had net current assets of RMB639.5 million as of December 31, 2020, compared to net current assets of RMB147.6 million as of December 31, 2019. The change was primarily due to an increase in cash and cash equivalents of RMB508.4 million, which was primarily in

FINANCIAL INFORMATION

connection with the series D financing from certain investors in 2020. For details, see “History, Restructuring and Corporate Structure—Establishment and Development of Our Company—(2) [REDACTED] Investment and Major Shareholding Changes of Our Company—(m) Series D Financing (November 2020 Capital Increase).”

Inventories

Our inventories consist of (i) raw materials; (ii) work in progress; and (iii) finished goods. We regularly monitor our inventories and endeavor to keep an optimal inventory level in line with the expected usages in the near term. For details, see “Business—Inventory.” The table below sets forth a breakdown of our inventories as of the dates indicated.

	As of December 31,	
	2019	2020
	<i>RMB'000</i>	<i>RMB'000</i>
Raw materials	5,875	10,377
Work in progress	1,060	3,783
Finished goods	1,703	4,263
Total	8,638	18,423

Our inventory balance increased from RMB8.6 million as of December 31, 2019 to RMB18.4 million as of December 31, 2020, primarily due to (i) an increase in raw materials of RMB4.5 million, as we purchased more raw materials in anticipation of expanded production, and (ii) an increase in finished goods of RMB2.6 million, as we anticipate increases in product demand as a result of positive developments in our business.

The table below sets forth our inventory and finished goods turnover days for the years indicated.

	For the year ended December 31,	
	2019	2020
	Inventory turnover days ⁽¹⁾	100

Note:

- (1) Inventory turnover days for a year is the arithmetic mean of the beginning and ending balances of inventory for the relevant year divided by the sum of cost of sales and raw material costs for R&D for the relevant year and multiplied by 365 days for 2019 and 2020.

FINANCIAL INFORMATION

Our inventory turnover days increased mainly reflects the necessity to maintain sufficient diabetes management products in anticipation of the growing demand of our products.

As of March 31, 2021, RMB13.3 million, representing 70.1% of our total inventories as of December 31, 2020, had been subsequently utilized.

Trade and Bills Receivables

Our trade and bills receivables represent balance due from certain customers. According to our trading terms with our customers, prepayment is normally required, except for certain customers, where credit period is allowed, and the credit period is generally within three months. We seek to maintain strict control over our outstanding receivables. Overdue balances are reviewed regularly by our senior management. For details, see “Business—Sales and Marketing—Our Sales Arrangements.” The following table sets forth a breakdown of our trade and bills receivables as of the dates indicated.

	As of December 31,	
	2019	2020
	<i>RMB'000</i>	<i>RMB'000</i>
Trade receivables	8,496	11,458
Bills receivable	45	244
Impairment	(1,155)	(1,343)
	7,386	10,359

Our trade receivables increased from RMB8.5 million as of December 31, 2019 to RMB11.5 million as of December 31, 2020, primarily driven by our revenue growth.

In determining impairment of trade receivables, the provision rates are based on ageing for groupings of various customer segments with similar loss patterns. The calculation reflects the probability-weighted outcome, the time value of money and reasonable and supportable information that is available at the end of 2019 and 2020 about past events, current conditions and forecasts of future economic conditions.

The table below sets forth our trade receivables turnover days for the years indicated:

	For the year ended December 31,	
	2019	2020
	Average trade receivables turnover days ⁽¹⁾	48

Note:

- (1) Trade receivables turnover days for a year is the arithmetic mean of the beginning and ending balances of trade receivables for the relevant year divided by the revenue for the relevant year and multiplied by 365 days for 2019 and 2020.

FINANCIAL INFORMATION

Our average trade receivables turnover days remains relatively stable in 2019 and 2020.

The following table sets forth an aging analysis of our trade receivables as of the dates indicated.

	For the year ended	
	December 31,	
	2019	2020
	<i>RMB'000</i>	<i>RMB'000</i>
Within 1 year	6,257	9,304
1 to 2 years	892	536
2 to 3 years	176	229
Over 3 years	16	46

As of March 31, 2021, RMB4.2 million, representing 36.6% of our trade receivables as of December 31, 2020 had been settled.

Prepayments, Other Receivables and Other Assets

Our current prepayments, other receivables and other assets primarily consist of (i) prepayments to our raw material suppliers and service providers, (ii) value-added tax recoverable, and (iii) other receivables. The following table sets forth a breakdown of our current prepayments, other receivables and other assets as of the dates indicated.

	As of December 31,	
	2019	2020
	<i>RMB'000</i>	<i>RMB'000</i>
Prepayments	2,761	3,143
Value-added tax recoverable	829	803
Other receivables	1,390	556
Total	4,980	4,502

Our current prepayments, other receivables and other assets decreased from RMB5.0 million as of December 31, 2019 to RMB4.5 million as of December 31, 2020. The decrease was primarily attributable to a decrease of RMB0.8 million in our other receivables primarily due to the release of the performance bond upon completion of the construction of our facilities, which was partially offset by an increase of RMB0.4 million in our prepayments in relation to our R&D activities.

FINANCIAL INFORMATION

Due from a Director

We had amount due from a Director of RMB9.6 million and nil as of December 31, 2019 and 2020, respectively. The balance as of December 31, 2019 mainly represented loan granted to Dr. Zheng Pan, which was settled in 2020.

Financial Assets at FVTPL

Our financial assets at FVTPL primarily consist of investments in financial products issued by commercial banks and other financial institutions in China.

Our financial assets at FVTPL decreased from RMB123.5 million as of December 31, 2019 to RMB105.2 million as of December 31, 2020, as we redeemed a portion of our investments in financial products, with the adoption of a more risk-averse treasury policy in 2020.

Cash and Cash Equivalents

Our cash and cash equivalents primarily consist of cash and bank balances. Our cash and cash equivalents increased from RMB41.4 million as of December 31, 2019 to RMB549.8 million as of December 31, 2020, primarily attributable to proceeds received from our equity financing in 2020.

Trade Payables

Our trade payables primarily consist of the balances due to our suppliers of raw materials. Our trade payables increased from RMB5.2 million as of December 31, 2019 to RMB7.6 million as of December 31, 2020, primarily due to increased purchases of raw materials in line with our overall business growth.

The table below sets forth our average trade payables turnover days for the years indicated.

	For the year ended	
	December 31,	
	2019	2020
Average trade payables turnover days ⁽¹⁾	58	61

Note:

- (1) Trade payables turnover days for a year is the arithmetic mean of the beginning and ending balances of trade payables for the relevant year divided by the cost of sales for the relevant year and multiplied by 365 days for 2019 and 2020.

Our trade payables turnover days increased from 58 days in 2019 to 61 days in 2020, primarily due to increased purchases of raw materials as a result of our overall business growth during the period.

FINANCIAL INFORMATION

The following table sets forth an aging analysis of the trade payables as of the dates indicated.

	For the year ended December 31,	
	2019	2020
	<i>RMB'000</i>	<i>RMB'000</i>
Within 1 year	5,238	7,482
1 to 2 years	2	110
2 to 3 years	8	–
Over 3 years	–	7

As of March 31, 2021, RMB6.6 million, representing 86.3% of our trade payables as of December 31, 2020, had been settled.

Contract Liabilities

Our contract liabilities represent our obligations to deliver our products to our customers for which we have received advanced payments from such customers under the relevant agreements or orders. Our contract liabilities increased from RMB5.3 million as of December 31, 2019 to RMB9.7 million as of December 31, 2020, which was in line with our revenue growth.

Other Payables and Accruals

Our other payables and accruals primarily consist of other payables, government grants to be amortized and accrued payroll. The following table sets forth a breakdown of our other payables and accruals as of the dates indicated.

	As of December 31,	
	2019	2020
	<i>RMB'000</i>	<i>RMB'000</i>
Other payables	10,158	8,946
Government grants	8,000	8,000
Accrued payroll	7,210	9,362
Accrued expenses	202	277
Refund liabilities	896	2,208
Taxes payable other than corporate income tax	847	2,481
Deferred revenue	98	40
Total	27,411	31,314

FINANCIAL INFORMATION

Our other payables and accruals increased from RMB27.4 million as of December 31, 2019 to RMB31.3 million as of December 31, 2020, which was primarily attributable to an increase in the accrued payroll mainly due to our increased number of employees.

LIQUIDITY AND CAPITAL RESOURCES

Overview

During the Track Record Period, we relied on capital contributions by our Shareholders as the major sources of liquidity. We also generate cash from our sales revenue of existing commercialized products, primarily including Equil and BGMS. As our business develops and expands, we expect to generate more net cash from our operating activities, through increasing sales revenue of the existing commercialized products and by launching new products, as a result of the broader market acceptance of our existing products and our continued efforts in marketing and expansion, improving cost control and operating efficiency and accelerating the turnover of trade receivables by tightening our credit policy.

With respect to cash management, our objective is to optimize liquidity to gain a better return for Shareholders and maintain adequate risk control. Specifically, we have policies in place to monitor and manage the settlement of trade receivables. When determining the credit term of a distributor, we consider a number of factors, including its cash flow conditions and creditworthiness. To monitor the settlement of our trade receivables and avoid credit losses, we conduct annual review of each distributor’s financial performance, which is primarily based on the amount and aging of the trade receivables due from such distributor in the respective period. Pursuant to our distribution agreement, when our distributor fails to make a payment within the credit term, we may, at our discretion, reduce or suspend our supply, terminate the distribution arrangement or take certain other measures as appropriate.

FINANCIAL INFORMATION

Cash Flows

The following table sets forth our cash flows for the years indicated.

	For the year ended	
	December 31,	
	2019	2020
	<i>RMB'000</i>	<i>RMB'000</i>
Cash flows from operating activities before changes in working capital	(23,182)	(10,252)
Changes in working capital	4,380	(1,699)
Interest received	848	2,376
Net cash flows used in operating activities	(17,954)	(9,575)
Net cash flows used in investing activities	(95,141)	(1,222)
Net cash flows from financing activities	100,876	511,276
Net increase/(decrease) in cash and cash equivalents	(12,219)	500,479
Cash and cash equivalent at beginning of the year	53,461	41,428
Effect of foreign exchange rate changes	186	(2,107)
Cash and cash equivalents at end of the year	<u>41,428</u>	<u>539,800</u>

Net Cash Flow Used in Operating Activities

In 2020, our net cash flows used in operating activities were RMB9.6 million, which was primarily attributable to cash used in operations of RMB12.0 million. Our cash used in operations mainly consisted of our loss before tax of RMB121.3 million adjusted for non-cash and non-operating items, primarily including equity-settled share award expense of RMB111.2 million. The amount was then adjusted downward by changes in working capital, primarily including an increase in inventories of RMB9.9 million, offset in part by an increase in other payables and accruals of RMB4.5 million.

FINANCIAL INFORMATION

In 2019, our net cash flows used in operating activities were RMB18.0 million, which was primarily attributable to cash used in operations of RMB18.8 million. Our cash used in operations mainly consisted of our loss before tax of RMB78.6 million adjusted for non-cash and non-operating items, primarily including equity-settled award expense of RMB57.6 million. The amount was then adjusted upward by changes in working capital, primarily including an increase in other payables and accruals of RMB7.0 million, offset in part by an increase in trade and bills receivables of RMB3.4 million.

Net Cash Flow Used in Investing Activities

In 2020, our net cash flows used in investing activities were RMB1.2 million. This was mainly attributable to purchases of financial assets at FVTPL of RMB195.5 million and our purchase of items of property, plant and equipment of RMB25.7 million, offset in part by our proceeds from sales of financial assets at FVTPL of RMB211.0 million.

In 2019, our net cash flows used in investing activities were RMB95.1 million. This was mainly attributable to our purchases of financial assets at FVTPL of RMB208.7 million and our purchase of items of property, plant and equipment of RMB28.6 million, offset in part by proceeds from sales of FVTPL of RMB150.8 million.

Net Cash Flow From Financing Activities

In 2020, our net cash flows generated from financing activities were RMB511.3 million. This was mainly attributable to the capital contribution by Shareholders of RMB513.2 million, offset in part by repayment of bank borrowing of RMB20.0 million.

In 2019, our net cash flows generated from financing activities were RMB100.9 million. This was mainly attributable to capital contribution by Shareholders of RMB91.9 million.

WORKING CAPITAL

The Directors are of the opinion that, taking into account of the following financial resources available to us described below, we have sufficient working capital to cover at least 125% of our costs, including R&D expenses, selling and distribution expenses, administrative expenses, finance costs and other expenses for at least the next 12 months from the date of this Document:

- our future operating cash flows in respective periods;
- cash and cash equivalents;
- available equity financing and bank facilities; and
- the estimated net [REDACTED] from the [REDACTED].

FINANCIAL INFORMATION

Our cash burn rate refers to the average monthly amount of cash operating costs and payments for property, plant and equipment. We had cash and cash equivalents of RMB539.8 million as of December 31, 2020. We estimate that we will receive net [REDACTED] of approximately HK\$[REDACTED] after deducting the [REDACTED] fees and expenses payable by us in the [REDACTED], assuming no [REDACTED] is exercised and assuming an [REDACTED] of HK\$[REDACTED] per [REDACTED], being the mid-point of the indicative [REDACTED] in this Document. Assuming an average cash burn rate going forward of two times the level in 2020, we estimate that our cash and cash equivalents as of December 31, 2020 will be able to maintain our financial viability for approximately 26 months, or if we take into account [REDACTED]% of the estimated net [REDACTED] from the [REDACTED] (namely, the portion allocated for our working capital and other general corporate purposes), approximately [REDACTED] months.

For details of our cash operating costs, see “—Cash Operating Costs.”

CASH OPERATING COSTS

The following table provides information regarding our cash operating costs for the years indicated.

	For the year ended	
	December 31,	
	2019	2020
	<i>RMB'000</i>	<i>RMB'000</i>
R&D costs for our Core Product	5,786	9,805
Service fee	669	1,906
Staff costs	3,134	5,540
Raw material costs	1,029	1,439
Others	954	920
R&D costs for our other product candidates	13,490	9,701
Service fee	5,078	661
Staff costs	6,611	5,796
Raw material costs	888	779
Others	913	2,465
Workforce employment costs⁽¹⁾	21,796	31,728
Product marketing costs	10,643	13,749
Direct production costs	21,897	30,724
Non-income taxes, royalties and other governmental charges	79	157
Others⁽²⁾	1,793	5,475

Notes:

- (1) Workforce employment costs represent total non-research and development personnel costs, mainly including salaries and benefits.
- (2) Others mainly include administrative expenses (other than employee benefits expenses).

FINANCIAL INFORMATION

INDEBTEDNESS

The following table sets forth a breakdown of our indebtedness as of the dates indicated.

	As of December 31,		As of March 31,
	2019	2020	2021
	<i>RMB'000</i>	<i>RMB'000</i>	<i>RMB'000</i> <i>(unaudited)</i>
Lease liabilities	–	126	127
Interest-bearing bank borrowing	10,012	–	–
Total	10,012	126	127

Lease Liabilities

Our total lease liabilities increased from nil as of December 31, 2019 to RMB126 thousand in 2020, primarily attributable to the lease we entered into in 2020 in Shanghai for use as a sales office. The lease liabilities remained relatively stable as of March 31, 2021 as compared to that of December 31, 2020.

Interest-bearing Bank Borrowing

Our interest-bearing bank borrowing consists of two secured bank loans. In 2019, we had a one-year secured bank loan in an aggregate principal amount of up to RMB10.0 million, bearing interest at an annual rate of 3.92%. In 2020, we had a one-year secured bank loan in an aggregate principal amount of up to RMB10.0 million, bearing interest at an annual rate of 4.05%. These bank loans were guaranteed by Dr. Zheng Pan, an executive Director. Our interest-bearing bank borrowing decreased from RMB10.0 million as of December 31, 2019 to nil as of December 31, 2020, because we repaid our bank loans in 2020. Our interest-bearing bank borrowing remained nil as of March 31, 2021.

The bank loan agreements contain standard events of default such as bankruptcy and an event that has a material adverse effect. Our Directors confirm that we had no material defaults in payment of interest-bearing bank and other borrowings and had not breached any finance covenants thereunder during the Track Record Period and up to the Latest Practicable Date. Our Directors also confirm that we are not subject to other material covenants under any agreements with respect to any bank loans or other borrowings.

We did not have any outstanding mortgages, charges, debentures, other issued debt capital, bank overdrafts, borrowings, liabilities under acceptance or other similar indebtedness, any guarantees or other material contingent liabilities as of March 31, 2020, being our indebtedness statement date. Our Directors confirm that we had no material defaults in payment of bank borrowings during the Track Record Period and up to the Latest Practicable

FINANCIAL INFORMATION

Date. Our Directors also confirm that we are not subject to any material covenants under any agreements with respect to any bank loans or other borrowings. Since March 31, 2021, the latest practicable date for the purpose of this indebtedness statement, and up to the date of this Document, there had been no material adverse change to our indebtedness.

CAPITAL EXPENDITURE

Our capital expenditure during the Track Record Period represented purchases of property, plant and equipment. The following table sets forth a breakdown of our capital expenditures for the years indicated.

	For the year ended December 31,	
	2019	2020
	<i>RMB'000</i>	<i>RMB'000</i>
Purchases of items of property, plant and equipment	29,597	26,074

We expect to incur capital expenditure in 2021 primarily to upgrade our existing production lines and purchase new machinery. For details, see “Future Plans and Use of [REDACTED].” We plan to fund our planned capital expenditures using our cash at bank and the net [REDACTED] received from the [REDACTED]. For more details, see “Future Plans and Use of [REDACTED].” We may reallocate the funds to be utilized on capital expenditures based on our ongoing business needs.

CONTRACTUAL OBLIGATIONS

Commitments

As of December 31, 2019 and 2020, the outstanding commitments in relation to our lease payments for non-cancellable lease contracts were RMB332 thousands and nil, respectively.

CONTINGENT LIABILITIES

As of December 31, 2019 and 2020, we did not have any contingent liabilities. We confirm that as of the Latest Practicable Date, there had been no material changes or arrangements to our contingent liabilities.

OFF-BALANCE SHEET COMMITMENTS AND ARRANGEMENTS

As of the Latest Practicable Date, we had not entered into any off-balance sheet transactions.

FINANCIAL INFORMATION

KEY FINANCIAL RATIOS

The following table sets forth our key financial ratios as of the dates indicated.

	As of December 31,	
	2019	2020
Current ratio ⁽¹⁾	4.1	14.1
Gearing ratio ⁽²⁾	4.6%	–
Quick ratio ⁽³⁾	3.9	13.7

Notes:

- (1) Current ratio represents current assets divided by current liabilities as of the same date.
- (2) Gearing ratio equals the total sum of interest-bearing bank borrowings and lease liabilities divided by total equity as of the end of the year.
- (3) Quick ratio represents current assets less inventories and divided by current liabilities as of the same date.

RELATED PARTY TRANSACTIONS

The following table sets forth transactions between us and our related parties during the Track Record Period.

	For the year ended December 31,	
	2019	2020
	<i>RMB'000</i>	<i>RMB'000</i>
Loans to:		
Dr. Zheng Pan	10,000	10,000
Shukang biomedical	–	500
	10,000	10,500
Repayment of loans to:		
Dr. Zheng Pan	–	20,000
Shukang biomedical	–	500
	–	20,500

FINANCIAL INFORMATION

	For the year ended December 31,	
	2019	2020
	<i>RMB'000</i>	<i>RMB'000</i>
Interest receivable from:		
Dr. Zheng Pan	303	299
Payment on behalf of the Group by:		
Dr. Zheng Pan	41	–
Repayment of payment on behalf of the Group by:		
Dr. Zheng Pan	–	389
Purchases of goods from:		
Jingxin Trading	–	1,182
Qirui Trading	–	593
Jingqi Trading	1,096	–
	1,096	1,775

In 2019 and 2020, we granted unsecured loans, at an interest rate of 3.83% and 4.03% per annum, to Dr. Zheng Pan, an executive Director, respectively. The loans are repayable within one year. Dr. Zheng Pan repaid the principal amount and interests of these loans in full as of December 31, 2020. In 2020, we granted unsecured loans to Shukang biomedical (Hangzhou) Co., Ltd (“**Shukang biomedical**”), an entity controlled by Dr. Zheng Pan. The loans are repayable on demand. Shukang biomedical repaid these loans in full as of December 31, 2020.

During the Track Record Period, the payment on behalf of the Group and the repayment of payment on behalf of the Group by Dr. Zheng Pan were related to certain expenses incurred in our ordinary course of business.

During the Track Record Period, we purchased goods from certain related parties, including Jinhua City Wucheng District Jingxin Trading Corporation (“**Jingxin Trading**”), Jinhua City Wucheng District Qirui Trading Corporation (“**Qirui Trading**”) and Jinhua City Wucheng District Jingqi Trading Corporation (“**Jingqi Trading**”), entities controlled by a relative of Dr. Zheng Pan, our executive Director. Such purchases primarily include packaging materials for our production and were made according to the published prices and conditions offered by the related parties to their major customers.

FINANCIAL INFORMATION

Other than the above, Dr. Zheng Pan, an executive Director, guaranteed our Group’s bank loans up to RMB10.0 million and RMB10.0 million in 2019 and 2020, respectively. We repaid the loans in full in 2020, and thus the relevant personal guarantee provided by Dr. Zheng Pan was released in full.

The below table sets forth outstanding balances with related parties as of the dates indicated.

	As of December 31,	
	2019	2020
	RMB’000	RMB’000
Due from a director:		
Dr. Zheng Pan	9,622	–
Prepayments, other receivables and other assets:		
Jingxin Trading	123	–
Trade payable:		
Jingqi Trading	249	–

Our Directors confirm that all material related party transactions during the Track Record Period were conducted on an arm’s length basis, and would not distort our results of operations over the Track Record Period or make our historical results over the Track Record Period not reflective of our expectations for our future performance. The outstanding balances with related parties were settled in 2020. Details of our transactions with related parties during the Track Record Period are set out in Note 31 to the Accountants’ Report included in Appendix I to this Document.

MARKET AND OTHER FINANCIAL RISKS

We are exposed to a variety of market and other financial risks, including credit risk, liquidity risk, interest rate risk and currency risk. We manage and monitor these exposures to ensure appropriate measures are implemented on a timely and effective manner.

Foreign Currency Risk

Foreign currency risk is the risk of loss resulting from changes in foreign currency exchange rates. Fluctuations in exchange rates between RMB and other currencies in which we conduct business may affect our financial condition and results of operations. We seek to limit our exposure to foreign currency risk by minimizing our net foreign currency position.

FINANCIAL INFORMATION

Credit Risk

We are exposed to credit risk in relation to our cash and cash equivalents, pledged deposits, amounts due from related parties, amounts due from a director, trade receivables and financial assets included in prepayments, other receivables and other assets. The carrying amounts of each class of the above financial assets represent our maximum exposure to credit risk in relation to financial assets. For further details, see Note 34 to the Accountants' Report set out in Appendix I to this Document.

Liquidity Risk

In the management of the liquidity risk, we monitor and maintain a level of cash and cash equivalents deemed adequate by our management to finance the operations and mitigate the effects of fluctuations in cash flows. For further details, see Note 34 to the Accountants' Report set out in Appendix I to this Document.

DIVIDENDS

No dividend has been paid or declared by us for the years ended December 31, 2019 and 2020, respectively. You should note that historical dividend distributions are not indicative of our future dividend distribution policy.

After completion of the [REDACTED], our Shareholders will be entitled to receive dividends we declare. As of the Latest Practicable Date, we did not have a formal dividend policy. The Board has approved a dividend policy, which will become effective upon [REDACTED]. Under the dividend policy, we intend to provide our Shareholders with interim or annual dividends as appropriate. The Board is required to consider, among other things, the following factors when proposing dividends and determining the amount of dividends:

- our actual and projected financial performance;
- our estimated working capital requirements, capital expenditure requirements and future business expansion plan;
- our present and future cash flow;
- other internal and external factors that may have an impact on our business operations or financial performance and position; and
- other factors that our Board of Directors deem relevant.

Any declaration and payment as well as the amount of dividends will be subject to our constitutional documents, including (where required) the approval of our Shareholders.

FINANCIAL INFORMATION

PRC laws require that dividends be paid only out of our distributable profits. Distributable profits are our after-tax profits, less any recovery of accumulated losses and appropriations to statutory and other reserves that we are required to make. As a result, we may not have sufficient or any distributable profits to make dividend distributions to our Shareholders, even if we become profitable. Any distributable profits not distributed in a given year are retained and available for distribution in subsequent years. Our dividend distribution may also be restricted if we incur debt or losses or in accordance with any restrictive covenants in bank credit facilities, convertible bond instruments or other agreements that we or our subsidiary may enter into in the future.

DISTRIBUTABLE RESERVES

As of December 31, 2020, our Group had no retained profits under HKFRSs as reserves available for distribution to our Shareholders.

[REDACTED] EXPENSES

Our [REDACTED] expenses mainly include professional fees paid and payable to the professional parties, and [REDACTED] payable to the [REDACTED], for their services rendered in relation to the [REDACTED] and the [REDACTED]. The estimated total [REDACTED] expenses (based on the mid-point of the indicative [REDACTED] and assuming that the [REDACTED] is not exercised) are approximately HK\$ [REDACTED], of which approximately HK\$[REDACTED] is expected to be charged to our consolidated statements of comprehensive income and the remaining amount of HK\$[REDACTED] million is expected to be recognized directly as a deduction from equity upon the [REDACTED]. The [REDACTED] expenses above are the latest practicable estimate for reference only, and the actual amount may differ from this estimate.

[REDACTED]

FINANCIAL INFORMATION

[REDACTED]

FINANCIAL INFORMATION

NO MATERIAL ADVERSE CHANGE

Our Directors confirm that up to the date of this Document, there has been no material adverse change in our financial, operational or trading positions or prospects since December 31, 2020, being the end of the period reported on as set out in the Accountants’ Report included in Appendix I to this Document.

DISCLOSURE REQUIRED UNDER THE LISTING RULES

Our Directors confirm that, as of the Latest Practicable Date, there was no circumstance that would give rise to a disclosure requirement under Rules 13.13 to 13.19 of the Listing Rules.

FUTURE PLANS AND USE OF [REDACTED]

FUTURE PLANS

See “Business—Our Strategies” for a detailed description of our future plans.

USE OF [REDACTED]

We estimate that we will receive net [REDACTED] of approximately HK\$[REDACTED] million after deducting the [REDACTED] fees and expenses payable by us in the [REDACTED], assuming no [REDACTED] is exercised and assuming an [REDACTED] of HK\$[REDACTED] per [REDACTED], being the mid-point of the indicative [REDACTED] of HK\$[REDACTED] to HK\$[REDACTED] per [REDACTED] in this Document. We intend to use the net [REDACTED] we will receive from the [REDACTED] for the following purposes, subject to changes in light of our evolving business needs and changing market conditions:

- [REDACTED]%, or approximately HK\$[REDACTED] allocated to our Core Product as follows:
 - (i) [REDACTED]%, or approximately HK\$[REDACTED], will be used to fund pre-clinical studies to improve the features of our Core Product and its further development. See “Business—Our Products and Product Pipeline—Equil – Core Product—Research and Development Plans.”
 - (ii) [REDACTED]%, or approximately HK\$[REDACTED], will be used to fund ongoing and planned clinical trials of our Core Product for its further development, including but not limited to clinical trials for our Core Product’s indication expansion, to prepare for and carry out registration of our Core Product in major markets worldwide. See “Business—Our Products and Product Pipeline—Equil – Core Product—Research and Development Plans.”
 - (iii) [REDACTED]%, or approximately HK\$[REDACTED], will be used to fund the establishment of our cloud-based diabetes management platform which is expected to provide integrated value-added services to patients and healthcare providers utilizing our Core Product to support the post-marketing operation and feedback collection for further R&D of our Core Product. See “Business—Research and Development—Cloud-based Diabetes Management Platform.”

FUTURE PLANS AND USE OF [REDACTED]

- (iv) [REDACTED]%, or approximately HK\$[REDACTED], will be used to fund the expansion of our manufacturing capacity of our Core Product, by upgrading our existing production lines and purchasing new machinery. See “Business—Our Strategies—Continue to increase our manufacturing capacity to support our growth and achieve economies of scale.”
- (v) [REDACTED]%, or approximately HK\$[REDACTED], will be used to enhance our commercialization capabilities for our Core Product through expanding our global footprint by recruiting high-caliber sales staff with extensive local experience and establishing long-term cooperation with leading distribution partners, and organizing and participating in academic conferences and activities, among other efforts. See “Business—Our Strategies—Continue to expand our global footprint through a user-centric and clinical-data driven sales strategy and a diversified commercialization channel.”
- [REDACTED]%, or approximately HK\$[REDACTED] allocated to our CGMS as follows:
 - (i) [REDACTED]%, or approximately HK\$[REDACTED], will be used to fund the pre-clinical studies, including but not limited to develop the second generation of our CGMS product, AiDEX X, which is designed for non-intensive diabetics, pre-diabetics, and health-aware non-diabetic users. See “Business—Our Products and Product Pipeline—AiDEX CGMS—Research and Development Plans.”
 - (ii) [REDACTED]%, or approximately HK\$[REDACTED], will be used to fund clinical trials of our AiDEX G7, including but not limited to clinical trials for its indication expansion to use by children and adolescents and clinical trials for the development of our AiDEX X, to prepare for and carry out its registration in major markets worldwide. See “Business—Our Products and Product Pipeline—AiDEX CGMS—Research and Development Plans.”
 - (iii) [REDACTED]%, or approximately HK\$[REDACTED], will be used to fund the expansion of our manufacturing capacity of our CGMS, by upgrading our existing production lines and purchasing new machinery. See “Business—Our Strategies—Continue to increase our manufacturing capacity to support our growth and achieve economies of scale.”

FUTURE PLANS AND USE OF [REDACTED]

- (iv) [REDACTED]%, or approximately HK\$[REDACTED], will be used to enhance our commercialization capabilities for our CGMS through expanding our global footprint by recruiting high-caliber sales staff with extensive local experience and establishing long-term cooperation with leading distribution partners, and organizing and participating in academic conferences and activities, among other efforts. See “Business—Our Strategies—Continue to expand our global footprint through a user-centric and clinical-data-driven sales strategy and a diversified commercialization channel.”
- [REDACTED]%, or approximately HK\$[REDACTED] allocated to the pre-clinical studies, clinical trials, registration, manufacturing and commercialization of our other products and product candidates.
 - [REDACTED]%, or approximately HK\$[REDACTED], allocated for working capital and other general corporate purposes.

The allocation of the [REDACTED] used for the above will be adjusted in the event that the [REDACTED] is fixed at a higher or lower level compared to the mid-point of the estimated [REDACTED]. If the [REDACTED] is fixed at HK\$[REDACTED] per [REDACTED], being the high end of the stated [REDACTED], our net [REDACTED] will be increased by approximately HK\$[REDACTED], assuming the [REDACTED] is not exercised. In such circumstances, we currently intend to use such additional [REDACTED] to increase the net [REDACTED] applied for the same purposes as set out above on a pro rata basis. If the [REDACTED] is fixed at HK\$[REDACTED] per [REDACTED], being the low end of the stated [REDACTED], our net [REDACTED] will be decreased by approximately HK\$[REDACTED], assuming the [REDACTED] is not exercised. In such circumstances, we currently intend to reduce the net [REDACTED] applied for the same purposes as set out above on a pro rata basis.

If the [REDACTED] is exercised in full, the net [REDACTED] that we will receive will be approximately HK\$[REDACTED], assuming an [REDACTED] of HK\$[REDACTED] per [REDACTED], being the mid-point of the proposed [REDACTED]. The Company may be required to issue up to an aggregate of [REDACTED] additional H Shares pursuant to the [REDACTED].

To the extent that the net [REDACTED] of the [REDACTED] are not immediately required for the above purposes or if we are unable to put into effect any part of our development plan as intended, we may hold such funds in short-term deposits so long as it is deemed to be in the best interests of the Company. In such event, we will comply with the appropriate disclosure requirements under the Listing Rules.

[REDACTED]

[REDACTED]

[REDACTED]

[REDACTED]

[REDACTED]

[REDACTED]

[REDACTED]

[REDACTED]

[REDACTED]

[REDACTED]

[REDACTED]

[REDACTED]

[REDACTED]

[REDACTED]

[REDACTED]

[REDACTED]

[REDACTED]

[REDACTED]

[REDACTED]

[REDACTED]

[REDACTED]

[REDACTED]

[REDACTED]

[REDACTED]

STRUCTURE OF THE [REDACTED]

[REDACTED]

STRUCTURE OF THE [REDACTED]

[REDACTED]

STRUCTURE OF THE [REDACTED]

[REDACTED]

STRUCTURE OF THE [REDACTED]

[REDACTED]

STRUCTURE OF THE [REDACTED]

[REDACTED]

STRUCTURE OF THE [REDACTED]

[REDACTED]

STRUCTURE OF THE [REDACTED]

[REDACTED]

STRUCTURE OF THE [REDACTED]

[REDACTED]

STRUCTURE OF THE [REDACTED]

[REDACTED]

STRUCTURE OF THE [REDACTED]

[REDACTED]

STRUCTURE OF THE [REDACTED]

[REDACTED]

STRUCTURE OF THE [REDACTED]

[REDACTED]

HOW TO APPLY FOR [REDACTED]

[REDACTED]

HOW TO APPLY FOR [REDACTED]

[REDACTED]

HOW TO APPLY FOR [REDACTED]

[REDACTED]

HOW TO APPLY FOR [REDACTED]

[REDACTED]

HOW TO APPLY FOR [REDACTED]

[REDACTED]

HOW TO APPLY FOR [REDACTED]

[REDACTED]

HOW TO APPLY FOR [REDACTED]

[REDACTED]

HOW TO APPLY FOR [REDACTED]

[REDACTED]

HOW TO APPLY FOR [REDACTED]

[REDACTED]

HOW TO APPLY FOR [REDACTED]

[REDACTED]

HOW TO APPLY FOR [REDACTED]

[REDACTED]

HOW TO APPLY FOR [REDACTED]

[REDACTED]

HOW TO APPLY FOR [REDACTED]

[REDACTED]

HOW TO APPLY FOR [REDACTED]

[REDACTED]

HOW TO APPLY FOR [REDACTED]

[REDACTED]

HOW TO APPLY FOR [REDACTED]

[REDACTED]

HOW TO APPLY FOR [REDACTED]

[REDACTED]

HOW TO APPLY FOR [REDACTED]

[REDACTED]

HOW TO APPLY FOR [REDACTED]

[REDACTED]

HOW TO APPLY FOR [REDACTED]

[REDACTED]

HOW TO APPLY FOR [REDACTED]

[REDACTED]

HOW TO APPLY FOR [REDACTED]

[REDACTED]

HOW TO APPLY FOR [REDACTED]

[REDACTED]

APPENDIX I

ACCOUNTANTS’ REPORT

The following is the text of a report received from the Company’s reporting accountants, Ernst & Young, Certified Public Accountants, Hong Kong, for the purpose of incorporation in this document.

[To insert the firm’s letterhead]

ACCOUNTANTS’ REPORT ON HISTORICAL FINANCIAL INFORMATION TO THE DIRECTORS OF MICROTECH MEDICAL (HANGZHOU) CO., LTD. AND GOLDMAN SACHS (ASIA) L.L.C AND CHINA INTERNATIONAL CAPITAL CORPORATION HONG KONG SECURITIES LIMITED

Introduction

We report on the historical financial information of MicroTech Medical (Hangzhou) Co., Ltd. (the “Company”) and its subsidiary (together, the “Group”) set out on pages [I-3] to [I-58], which comprises the consolidated statements of profit or loss and other comprehensive income, statements of changes in equity and statements of cash flows of the Group for each of the years ended 31 December 2019 and 2020 (the “Relevant Periods”), and the consolidated statements of financial position of the Group and the statements of financial position of the Company as at 31 December 2019 and 2020 and a summary of significant accounting policies and other explanatory information (together, the “Historical Financial Information”). The Historical Financial Information set out on pages [I-3] to [I-58] forms an integral part of this report, which has been prepared for inclusion in the document of the Company dated [REDACTED] (the “Document”) in connection with the initial [REDACTED] of the shares of the Company on the Main Board of The Stock Exchange of Hong Kong Limited (the “Stock Exchange”).

Directors’ responsibility for the Historical Financial Information

The directors of the Company are responsible for the preparation of the Historical Financial Information that gives a true and fair view in accordance with the basis of preparation set out in note 2.1 to the Historical Financial Information, and for such internal control as the directors determine is necessary to enable the preparation of the Historical Financial Information that is free from material misstatement, whether due to fraud or error.

Reporting accountants’ responsibility

Our responsibility is to express an opinion on the Historical Financial Information and to report our opinion to you. We conducted our work in accordance with Hong Kong Standard on Investment Circular Reporting Engagements 200 *Accountants’ Reports on Historical Financial Information in Investment Circulars* issued by the Hong Kong Institute of Certified Public Accountants (“HKICPA”). This standard requires that we comply with ethical standards and plan and perform our work to obtain reasonable assurance about whether the Historical Financial Information is free from material misstatement.

Our work involved performing procedures to obtain evidence about the amounts and disclosures in the Historical Financial Information. The procedures selected depend on the reporting accountants’ judgement, including the assessment of risks of material misstatement

APPENDIX I

ACCOUNTANTS' REPORT

of the Historical Financial Information, whether due to fraud or error. In making those risk assessments, the reporting accountants consider internal control relevant to the entity's preparation of the Historical Financial Information that gives a true and fair view in accordance with the basis of preparation set out in note 2.1 to the Historical Financial Information in order to design procedures that are appropriate in the circumstances, but not for the purpose of expressing an opinion on the effectiveness of the entity's internal control. Our work also included evaluating the appropriateness of accounting policies used and the reasonableness of accounting estimates made by the directors, as well as evaluating the overall presentation of the Historical Financial Information.

We believe that the evidence we have obtained is sufficient and appropriate to provide a basis for our opinion.

Opinion

In our opinion, the Historical Financial Information gives, for the purposes of the accountants' report, a true and fair view of the financial position of the Group and the Company as at 31 December 2019 and 2020 and of the financial performance and cash flows of the Group for each of the Relevant Periods in accordance with the basis of preparation set out in note 2.1 to the Historical Financial Information.

Report on matters under the Rules Governing the Listing of Securities on the Stock Exchange and the Companies (Winding Up and Miscellaneous Provisions) Ordinance

Adjustments

In preparing the Historical Financial Information, no adjustments to the Underlying Financial Statements as defined on page I-3 have been made.

Dividends

We refer to note 11 to the Historical Financial Information which states that no dividends have been paid by the Company in respect of the Relevant Periods.

[●]

Certified Public Accountants

Hong Kong

[Date]

I HISTORICAL FINANCIAL INFORMATION

Preparation of Historical Financial Information

Set out below is the Historical Financial Information which forms an integral part of this accountants’ report.

The financial statements of the Group for the Relevant Periods, on which the Historical Financial Information is based, were audited by Ernst & Young in accordance with Hong Kong Standards on Auditing issued by the HKICPA (the “Underlying Financial Statements”).

The Historical Financial Information is presented in Renminbi (“RMB”) and all values are rounded to the nearest thousand (RMB’000) except when otherwise indicated.

APPENDIX I

ACCOUNTANTS’ REPORT

CONSOLIDATED STATEMENTS OF PROFIT OR LOSS AND OTHER COMPREHENSIVE INCOME

		Year ended 31 December 2019	Year ended 31 December 2020
	<i>Notes</i>	<i>RMB'000</i>	<i>RMB'000</i>
REVENUE	5	51,863	75,277
Cost of sales		<u>(27,780)</u>	<u>(38,733)</u>
Gross profit		24,083	36,544
Other income and gains	5	8,716	27,663
Selling and distribution expenses		(27,003)	(55,059)
Administrative expenses		(33,615)	(45,758)
Impairment losses on financial assets, net		(423)	(188)
Research and development costs		(50,060)	(82,009)
Other expenses		(1)	(2,135)
Finance costs	7	<u>(311)</u>	<u>(308)</u>
LOSS BEFORE TAX	6	(78,614)	(121,250)
Income tax expense	10	<u>–</u>	<u>–</u>
LOSS AND TOTAL COMPREHENSIVE LOSS FOR THE YEAR		<u>(78,614)</u>	<u>(121,250)</u>
Attributable to:			
Owners of the parent		(78,614)	(121,009)
Non-controlling interest		<u>–</u>	<u>(241)</u>
		<u>(78,614)</u>	<u>(121,250)</u>
LOSS PER SHARE ATTRIBUTABLE TO ORDINARY EQUITY HOLDERS OF THE PARENT			
Basic and diluted	12	<u>RMB(0.28)</u>	<u>RMB(0.39)</u>

APPENDIX I

ACCOUNTANTS’ REPORT

CONSOLIDATED STATEMENTS OF FINANCIAL POSITION

		As at 31 December 2019	As at 31 December 2020
	<i>Notes</i>	<i>RMB’000</i>	<i>RMB’000</i>
NON-CURRENT ASSETS			
Property, plant and equipment	<i>13</i>	43,341	65,965
Intangible assets	<i>15</i>	16,130	14,454
Right-of-use assets	<i>14(a)</i>	7,124	6,962
Prepayments, other receivables and other assets	<i>18</i>	2,599	1,617
Total non-current assets		<u>69,194</u>	<u>88,998</u>
CURRENT ASSETS			
Inventories	<i>16</i>	8,638	18,423
Trade and bills receivables	<i>17</i>	7,386	10,359
Prepayments, other receivables and other assets	<i>18</i>	4,980	4,502
Due from a director	<i>19</i>	9,622	–
Financial assets at fair value through profit or loss	<i>20</i>	123,495	105,192
Cash and cash equivalents	<i>21</i>	41,428	549,800
Total current assets		<u>195,549</u>	<u>688,276</u>
CURRENT LIABILITIES			
Trade payables	<i>22</i>	5,248	7,599
Lease liabilities	<i>14(b)</i>	–	126
Other payables and accruals	<i>23</i>	27,411	31,314
Interest-bearing bank borrowing	<i>24</i>	10,012	–
Contract liabilities	<i>25</i>	5,282	9,718
Total current liabilities		<u>47,953</u>	<u>48,757</u>
NET CURRENT ASSETS		<u>147,596</u>	<u>639,519</u>
TOTAL ASSETS LESS CURRENT LIABILITIES		<u>216,790</u>	<u>728,517</u>
Net assets		<u>216,790</u>	<u>728,517</u>
EQUITY			
Equity attributable to owners of the parent			
Share capital	<i>26</i>	–	360,000
Paid-in capital	<i>26</i>	74,402	–
Reserves	<i>27</i>	142,388	368,517
Total equity		<u>216,790</u>	<u>728,517</u>

APPENDIX I

ACCOUNTANTS’ REPORT

CONSOLIDATED STATEMENTS OF CHANGES IN EQUITY

Year ended 31 December 2019

	Attributable to owners of the parent					
	Share capital	Paid-in capital	Other reserves*	Share award reserve*	Accumulated losses*	Total equity
	<i>RMB'000</i> <i>(note 26)</i>	<i>RMB'000</i> <i>(note 26)</i>	<i>RMB'000</i> <i>(note 27)</i>	<i>RMB'000</i> <i>(note 27)</i>	<i>RMB'000</i>	<i>RMB'000</i>
At 1 January 2019	–	69,683	167,920	23,090	(114,753)	145,940
Loss for the year	–	–	–	–	(78,614)	(78,614)
Total comprehensive loss for the year	–	–	–	–	(78,614)	(78,614)
Capital contribution by shareholders	–	4,719	87,181	–	–	91,900
Equity-settled share award expense	–	–	–	57,564	–	57,564
At 31 December 2019	–	74,402	255,101	80,654	(193,367)	216,790

Year ended 31 December 2020

	Attributable to owners of the parent								
	Share capital	Paid-in capital	Share premium*	Other reserves*	Share award reserve*	Retained profits/ (accumulated losses)*	Total	Non-controlling interest	Total equity
	<i>RMB'000</i> <i>(note 26)</i>	<i>RMB'000</i> <i>(note 26)</i>	<i>RMB'000</i> <i>(note 27)</i>	<i>RMB'000</i> <i>(note 27)</i>	<i>RMB'000</i> <i>(note 27)</i>	<i>RMB'000</i>	<i>RMB'000</i>	<i>RMB'000</i>	<i>RMB'000</i>
At 1 January 2020	–	74,402	–	255,101	80,654	(193,367)	216,790	–	216,790
Loss for the year	–	–	–	–	–	(121,009)	(121,009)	(241)	(121,250)
Total comprehensive loss for the year	–	–	–	–	–	(121,009)	(121,009)	(241)	(121,250)
Equity-settled share award expense	–	–	–	–	111,176	–	111,176	–	111,176
Acquisition of non-controlling interests	–	–	–	(241)	–	–	(241)	241	–
Conversion into a joint stock company	83,023	(83,023)	–	(383,321)	–	383,321	–	–	–
Capital contribution by shareholders	12,173	8,621	501,007	–	–	–	521,801	–	521,801
Transfer from reserves to share capital	264,804	–	(264,804)	–	–	–	–	–	–
At 31 December 2020	360,000	–	236,203	(128,461)	191,830	68,945	728,517	–	728,517

* These reserve accounts comprise the consolidated reserves of RMB142,388,000 and RMB368,517,000 in the consolidated statements of financial position as at 31 December 2019 and 2020, respectively.

APPENDIX I

ACCOUNTANTS’ REPORT

CONSOLIDATED STATEMENTS OF CASH FLOWS

		Year ended 31 December 2019	Year ended 31 December 2020
	<i>Notes</i>	<i>RMB’000</i>	<i>RMB’000</i>
CASH FLOWS FROM OPERATING ACTIVITIES			
Loss before tax		(78,614)	(121,250)
Adjustments for:			
Finance costs	7	311	308
Bank interest income	5	(848)	(2,376)
Investment income from financial assets at fair value through profit or loss	5	(5,374)	(5,768)
Gain on disposal of items of property, plant and equipment	5	(62)	(227)
Depreciation of property, plant and equipment	13	1,106	3,287
Depreciation of right-of-use assets	14(a)	867	493
Amortisation of intangible assets	15	1,457	1,704
Impairment of trade receivables	17	423	188
Write-down of inventories to net realisable value	6	174	106
Equity-settled share award expense	28	57,564	111,176
Foreign exchange differences, net	6	(186)	2,107
		(23,182)	(10,252)
Increase in inventories		(2,085)	(9,891)
Increase in trade and bills receivables		(3,350)	(3,161)
Decrease/(increase) in prepayments, other receivables and other assets		(1,430)	478
Decrease/(increase) in an amount due from a director		378	(378)
Increase in trade payables		1,615	2,351
Increase in other payables and accruals		7,006	4,466
Decrease in an amount due to a director		(349)	–
Increase in contract liabilities		2,595	4,436
		(18,802)	(11,951)
Cash used in operations		848	2,376
Interest received		(17,954)	(9,575)
Net cash flows used in operating activities		(17,954)	(9,575)
CASH FLOWS FROM INVESTING ACTIVITIES			
Purchases of items of property, plant and equipment		(28,571)	(25,655)
Proceeds from disposal of property, plant and equipment		62	390
Purchases of intangible assets	15	(1,947)	(28)
Purchases of financial assets at fair value through profit or loss		(208,700)	(195,500)

APPENDIX I

ACCOUNTANTS’ REPORT

		Year ended 31 December 2019	Year ended 31 December 2020
	<i>Notes</i>	<i>RMB’000</i>	<i>RMB’000</i>
Proceeds from maturity of financial assets at fair value through profit or loss		150,750	211,000
Investment income from financial assets at fair value through profit or loss		3,265	8,571
Loans to a director		(10,000)	(10,000)
Repayment of loans to a director		–	20,000
Increase in time deposits with original maturity of over three months		–	(10,000)
Net cash flows used in investing activities		<u>(95,141)</u>	<u>(1,222)</u>
CASH FLOWS FROM FINANCING ACTIVITIES			
Capital contribution by shareholders		91,900	513,180
New bank borrowings		10,000	10,000
Repayment of bank borrowings		–	(20,000)
Capital injection from the exercise of equity-settled share award		–	8,621
Principal portion of lease payments	<i>30(c)</i>	(725)	(205)
Interest paid		(299)	(320)
Net cash flows from financing activities		<u>100,876</u>	<u>511,276</u>
NET INCREASE/(DECREASE) IN CASH AND CASH EQUIVALENTS			
Cash and cash equivalents at beginning of year		53,461	41,428
Effect of foreign exchange rate changes, net		186	(2,107)
CASH AND CASH EQUIVALENTS AT END OF YEAR		<u>41,428</u>	<u>539,800</u>
ANALYSIS OF BALANCES OF CASH AND CASH EQUIVALENTS			
Cash and cash equivalents as stated in the consolidated statements of financial position	<i>21</i>	41,428	549,800
Time deposits with original maturity of over three months when acquired		–	(10,000)
Cash and cash equivalents as stated in the consolidated statements of cash flows		<u>41,428</u>	<u>539,800</u>

APPENDIX I

ACCOUNTANTS’ REPORT

STATEMENTS OF FINANCIAL POSITION OF THE COMPANY

		As at 31 December 2019	As at 31 December 2020
	<i>Notes</i>	<i>RMB’000</i>	<i>RMB’000</i>
NON-CURRENT ASSETS			
Property, plant and equipment	<i>13</i>	43,341	65,965
Intangible assets	<i>15</i>	16,130	14,429
Right-of-use assets	<i>14(a)</i>	7,124	6,962
Investment in a subsidiary		310	1,000
Prepayments, other receivables and other assets	<i>18</i>	2,599	1,617
Total non-current assets		<u>69,504</u>	<u>89,973</u>
CURRENT ASSETS			
Inventories	<i>16</i>	8,638	18,345
Trade and bills receivables	<i>17</i>	7,386	10,359
Prepayments, other receivables and other assets	<i>18</i>	4,900	4,027
Due from a director	<i>19</i>	9,622	–
Due from a subsidiary		–	1,170
Financial assets at fair value through profit or loss	<i>20</i>	123,495	105,192
Cash and cash equivalents	<i>21</i>	41,198	549,378
Total current assets		<u>195,239</u>	<u>688,471</u>
CURRENT LIABILITIES			
Trade payables	<i>22</i>	5,248	7,578
Lease liabilities	<i>14(b)</i>	–	126
Other payables and accruals	<i>23</i>	27,411	31,103
Interest-bearing bank borrowing	<i>24</i>	10,012	–
Contract liabilities	<i>25</i>	5,282	9,718
Total current liabilities		<u>47,953</u>	<u>48,525</u>
NET CURRENT ASSETS		<u>147,286</u>	<u>639,946</u>
TOTAL ASSETS LESS CURRENT LIABILITIES		<u>216,790</u>	<u>729,919</u>
Net assets		<u><u>216,790</u></u>	<u><u>729,919</u></u>
EQUITY			
Share capital	<i>26</i>	–	360,000
Paid-in capital	<i>26</i>	74,402	–
Reserves	<i>27</i>	142,388	369,919
Total equity		<u><u>216,790</u></u>	<u><u>729,919</u></u>

APPENDIX I

ACCOUNTANTS’ REPORT

II NOTES TO THE HISTORICAL FINANCIAL INFORMATION

1. CORPORATE INFORMATION

The Company is a joint stock company with limited liability established in the People’s Republic of China (“PRC”). The registered office of the Company is located at No. 108 Liuze Street, Cangqian Street, Yuhang District, Hangzhou, Zhejiang, China.

During the Relevant Periods, the Company and its subsidiary were principally engaged in research and development and manufacture and commercialisation of diabetes management medical devices and consumables.

As at the end of the Relevant Periods, the Company had a direct interest in its subsidiary, which is a private limited liability company (has substantially similar characteristics to a private company incorporated in Hong Kong), the particulars of which are set out below:

Name	Place and date of incorporation/ registration and place of operations	Registered share capital	Percentage of equity attributable to the Company Direct	Principal activities
Hangzhou MicroTech E-Commerce Co., Ltd.* (“MicroTech E-Commerce”) 杭州微泰電子商務有限公司	PRC/Mainland China 19 September 2019	RMB1,000,000	100%	Commercialisation of diabetes management medical devices and consumables

No audited financial statements have been prepared for this subsidiary for the years ended 31 December 2019 and 2020, as the entity was not subject to any statutory audit requirements under the relevant rules and regulations in its jurisdiction of incorporation.

- * The English name of this subsidiary registered in the PRC represents the best efforts made by the management of the Company to directly translate its Chinese name as it did not register any official English name.

2.1 BASIS OF PREPARATION

The Historical Financial Information has been prepared in accordance with Hong Kong Financial Reporting Standards (“HKFRSs”) (which include all Hong Kong Financial Reporting Standards, Hong Kong Accounting Standards (“HKASs”) and Interpretations) issued by the HKICPA and accounting principles generally accepted in Hong Kong. All HKFRSs effective for the accounting period commencing from 1 January 2020, as well as the amendment to HKFRS 16 *Covid-19-Related Rent Concessions*, together with the relevant transitional provisions, have been consistently applied by the Group in the preparation of the Historical Financial Information throughout the Relevant Periods.

The Historical Financial Information has been prepared under the historical cost convention, except for financial assets measured at fair value through profit or loss which have been measured at fair value.

Basis of consolidation

The Historical Financial Information includes the financial information of the Company and its subsidiary (collectively referred to as the “Group”) for the Relevant Periods. A subsidiary is an entity (including a structured entity), directly or indirectly, controlled by the Company. Control is achieved when the Group is exposed, or has rights, to variable returns from its involvement with the investee and has the ability to affect those returns through its power over the investee (i.e., existing rights that give the Group the current ability to direct the relevant activities of the investee).

APPENDIX I

ACCOUNTANTS’ REPORT

When the Company has, directly or indirectly, less than a majority of the voting or similar rights of an investee, the Group considers all relevant facts and circumstances in assessing whether it has power over an investee, including:

- (a) the contractual arrangement with the other vote holders of the investee;
- (b) rights arising from other contractual arrangements; and
- (c) the Group’s voting rights and potential voting rights.

The financial information of the subsidiary is prepared for the same reporting period as the Company, using consistent accounting policies. The results of subsidiary are consolidated from the date on which the Group obtains control, and continue to be consolidated until the date that such control ceases.

Profit or loss and each component of other comprehensive income are attributed to the owners of the parent of the Group and to the non-controlling interests, even if this results in the non-controlling interests having a deficit balance. All intra-group assets and liabilities, equity, income, expenses and cash flows relating to transactions between members of the Group are eliminated in full on consolidation.

The Group reassesses whether or not it controls an investee if facts and circumstances indicate that there are changes to one or more of the three elements of control described above. A change in the ownership interest of a subsidiary, without a loss of control, is accounted for as an equity transaction.

If the Group loses control over a subsidiary, it derecognises (i) the assets (including goodwill) and liabilities of the subsidiary, (ii) the carrying amount of any non-controlling interest and (iii) the cumulative translation differences recorded in equity; and recognises (i) the fair value of the consideration received, (ii) the fair value of any investment retained and (iii) any resulting surplus or deficit in profit or loss. The Group’s share of components previously recognised in other comprehensive income is reclassified to profit or loss or accumulated losses, as appropriate, on the same basis as would be required if the Group had directly disposed of the related assets or liabilities.

2.2 ISSUED BUT NOT YET EFFECTIVE HONG KONG FINANCIAL REPORTING STANDARDS

Except for the amendment to HKFRS 16 *Covid-19-Related Rent Concessions*, the Group has not applied the following new and revised HKFRSs, that have been issued but are not yet effective, in the Historical Financial Information.

Amendments to HKFRS 3	<i>Reference to the Conceptual Framework</i> ²
Amendments to HKFRS 9, HKAS 39, HKFRS 7, HKFRS 4 and HKFRS 16	<i>Interest Rate Benchmark Reform – Phase 2</i> ¹
Amendments to HKFRS 10 and HKAS 28 (2011)	<i>Sale or Contribution of Assets between an Investor and its Associate or Joint Venture</i> ⁴
HKFRS 17	<i>Insurance Contracts</i> ³
Amendment to HKFRS 16	<i>Covid-19-Related Rent Concessions beyond 30 June 2021</i> ⁷
Amendments to HKFRS 17	<i>Insurance Contracts</i> ^{3, 6}
Amendments to HKAS 1	<i>Classification of Liabilities as Current or Non-current</i> ^{3, 5}
Amendments to HKAS 1	<i>Disclosure of Accounting Policies</i> ³
Amendments to HKAS 8	<i>Definition of Accounting Estimates</i> ³
Amendments to HKAS 16	<i>Property, Plant and Equipment: Proceeds before Intended Use</i> ²
Amendments to HKAS 37	<i>Onerous Contracts – Cost of Fulfilling a Contract</i> ²
<i>Annual Improvements to HKFRSs 2018-2020</i>	Amendments to HKFRS 1, HKFRS 9, Illustrative Examples accompanying HKFRS 16, and HKAS 41 ²

¹ Effective for annual periods beginning on or after 1 January 2021

² Effective for annual periods beginning on or after 1 January 2022

³ Effective for annual periods beginning on or after 1 January 2023

⁴ No mandatory effective date yet determined but available for adoption

APPENDIX I

ACCOUNTANTS’ REPORT

- ⁵ As a consequence of the amendments to HKAS 1, Hong Kong Interpretation 5 *Presentation of Financial Statements – Classification by the Borrower of a Term Loan that Contains a Repayment on Demand Clause* was revised in October 2020 to align the corresponding wording with no change in conclusion
- ⁶ As a consequence of the amendments to HKFRS 17 issued in October 2020, HKFRS 4 was amended to extend the temporary exemption that permits insurers to apply HKAS 39 rather than HKFRS 9 for annual periods beginning before 1 January 2023
- ⁷ Annual periods beginning on or after 1 April 2021

The Group is in the process of making an assessment of the impact of these new and revised HKFRSs upon initial application. So far, the Group considers that these new and revised HKFRSs may result in changes in accounting policies but are unlikely to have a significant impact on the Group’s financial performance and financial position.

2.3 SUMMARY OF SIGNIFICANT ACCOUNTING POLICIES

Fair value measurement

The Group measures unlisted investments at fair value at the end of each of the Relevant Periods. Fair value is the price that would be received to sell an asset or paid to transfer a liability in an orderly transaction between market participants at the measurement date. The fair value measurement is based on the presumption that the transaction to sell the asset or transfer the liability takes place either in the principal market for the asset or liability, or in the absence of a principal market, in the most advantageous market for the asset or liability. The principal or the most advantageous market must be accessible by the Group. The fair value of an asset or a liability is measured using the assumptions that market participants would use when pricing the asset or liability, assuming that market participants act in their economic best interest.

A fair value measurement of a non-financial asset takes into account a market participant’s ability to generate economic benefits by using the asset in its highest and best use or by selling it to another market participant that would use the asset in its highest and best use.

The Group uses valuation techniques that are appropriate in the circumstances and for which sufficient data are available to measure fair value, maximising the use of relevant observable inputs and minimising the use of unobservable inputs.

All assets and liabilities for which fair value is measured or disclosed in the Historical Financial Information are categorised within the fair value hierarchy, described as follows, based on the lowest level input that is significant to the fair value measurement as a whole:

- Level 1 – based on quoted prices (unadjusted) in active markets for identical assets or liabilities
- Level 2 – based on valuation techniques for which the lowest level input that is significant to the fair value measurement is observable, either directly or indirectly
- Level 3 – based on valuation techniques for which the lowest level input that is significant to the fair value measurement is unobservable

For assets and liabilities that are recognised in the Historical Financial Information on a recurring basis, the Group determines whether transfers have occurred between levels in the hierarchy by reassessing categorisation (based on the lowest level input that is significant to the fair value measurement as a whole) at the end of each of the Relevant Periods.

Impairment of non-financial assets

Where an indication of impairment exists, or when annual impairment testing for an asset is required (other than inventories and financial assets), the asset’s recoverable amount is estimated. An asset’s recoverable amount is the higher of the asset’s or cash-generating unit’s value in use and its fair value less costs of disposal, and is determined for an individual asset, unless the asset does not generate cash inflows that are largely independent of those from other assets or groups of assets, in which case the recoverable amount is determined for the cash-generating unit to which the asset belongs.

APPENDIX I

ACCOUNTANTS' REPORT

An impairment loss is recognised only if the carrying amount of an asset exceeds its recoverable amount. In assessing value in use, the estimated future cash flows are discounted to their present value using a pre-tax discount rate that reflects current market assessments of the time value of money and the risks specific to the asset. An impairment loss is charged to profit or loss in the period in which it arises in those expense categories consistent with the function of the impaired asset.

An assessment is made at the end of each of the Relevant Periods as to whether there is an indication that previously recognised impairment losses may no longer exist or may have decreased. If such an indication exists, the recoverable amount is estimated. A previously recognised impairment loss of an asset other than goodwill is reversed only if there has been a change in the estimates used to determine the recoverable amount of that asset, but not to an amount higher than the carrying amount that would have been determined (net of any depreciation/amortisation) had no impairment loss been recognised for the asset in prior years. A reversal of such an impairment loss is credited to profit or loss in the period in which it arises.

Related parties

A party is considered to be related to the Group if:

- (a) the party is a person or a close member of that person's family and that person
 - (i) has control or joint control over the Group;
 - (ii) has significant influence over the Group; or
 - (iii) is a member of the key management personnel of the Group or of a parent of the Group;

or

- (b) the party is an entity where any of the following conditions applies:
 - (i) the entity and the Group are members of the same group;
 - (ii) one entity is an associate or joint venture of the other entity (or of a parent, subsidiary or fellow subsidiary of the other entity);
 - (iii) the entity and the Group are joint ventures of the same third party;
 - (iv) one entity is a joint venture of a third entity and the other entity is an associate of the third entity;
 - (v) the entity is a post-employment benefit plan for the benefit of employees of either the Group or an entity related to the Group;
 - (vi) the entity is controlled or jointly controlled by a person identified in (a);
 - (vii) a person identified in (a)(i) has significant influence over the entity or is a member of the key management personnel of the entity (or of a parent of the entity); and
 - (viii) the entity, or any member of a group of which it is a part, provides key management personnel services to the Group or to the parent of the Group.

Property, plant and equipment and depreciation

Property, plant and equipment, are stated at cost less accumulated depreciation and any impairment losses. The cost of an item of property, plant and equipment comprises its purchase price and any directly attributable costs of bringing the asset to its working condition and location for its intended use.

Expenditure incurred after items of property, plant and equipment have been put into operation, such as repairs and maintenance, is normally charged to profit or loss in the period in which it is incurred. In situations where the recognition criteria are satisfied, the expenditure for a major inspection is capitalised in the carrying amount of the asset as a replacement. Where significant parts of property, plant and equipment are required to be replaced at intervals, the Group recognises such parts as individual assets with specific useful lives and depreciates them accordingly.

APPENDIX I

ACCOUNTANTS’ REPORT

Depreciation is calculated on the straight-line basis to write off the cost of each item of property, plant and equipment to its residual value over its estimated useful life. The estimated useful lives of property, plant and equipment are as follows:

Buildings	10 to 20 years
Machinery and equipment	3 to 10 years
Computer and office equipment	3 to 5 years
Motor vehicles	5 years

Where parts of an item of property, plant and equipment have different useful lives, the cost of that item is allocated on a reasonable basis among the parts and each part is depreciated separately. Residual values, useful lives and the depreciation methods are reviewed, and adjusted if appropriate, at least at each financial year end.

An item of property, plant and equipment including any significant part initially recognised is derecognised upon disposal or when no future economic benefits are expected from its use or disposal. Any gain or loss on disposal or retirement recognised in profit or loss in the year the asset is derecognised is the difference between the net sales proceeds and the carrying amount of the relevant asset.

Construction in progress represents a building under construction and machinery, equipment and office equipment under installation, which are stated at cost less any impairment losses, and are not depreciated. Cost comprises the direct costs of construction during the period of construction. Construction in progress is reclassified to the appropriate category of property, plant and equipment when completed and ready for use.

Intangible assets

Intangible assets acquired separately are measured on initial recognition at cost. The useful lives of intangible assets are assessed to be either finite or indefinite. Intangible assets with finite lives are subsequently amortised over the useful economic life and assessed for impairment whenever there is an indication that the intangible asset may be impaired. The amortisation period and the amortisation method for an intangible asset with a finite useful life are reviewed at least at each financial year end.

Intellectual property

Purchased intellectual property is stated at cost less any impairment losses and is amortised on the straight-line basis over its estimated useful life of 4 to 20 years, which is determined by considering the typical product life cycles and the technical obsolescence of the intellectual property.

Software

Purchased software is stated at cost less any impairment losses and amortised on the straight-line basis over its estimated useful life of 3 to 5 years.

Research and development costs

All research costs are charged to profit or loss as incurred.

Expenditure incurred on projects to develop new products is capitalised and deferred only when the Group can demonstrate the technical feasibility of completing the intangible asset so that it will be available for use or sale, its intention to complete and its ability to use or sell the asset, how the asset will generate future economic benefits, the availability of resources to complete the project and the ability to measure reliably the expenditure during the development. Product development expenditure which does not meet these criteria is expensed when incurred.

Leases

The Group assesses at contract inception whether a contract is, or contains, a lease. A contract is, or contains, a lease if the contract conveys the right to control the use of an identified asset for a period of time in exchange for consideration.

APPENDIX I

ACCOUNTANTS’ REPORT

Group as a lessee

The Group applies a single recognition and measurement approach for all leases, except for short-term leases. The Group recognises lease liabilities to make lease payments and right-of-use assets representing the right to use the underlying assets.

(a) Right-of-use assets

Right-of-use assets are recognised at the commencement date of the lease (that is the date the underlying asset is available for use). Right-of-use assets are measured at cost, less any accumulated depreciation and any impairment losses, and adjusted for any remeasurement of lease liabilities. The cost of right-of-use assets includes the amount of lease liabilities recognised, initial direct costs incurred, and lease payments made at or before the commencement date less any lease incentives received. Right-of-use assets are depreciated on a straight-line basis over the shorter of the lease terms and the estimated useful lives of the assets as follows:

Leasehold land	50 years
Warehouses and office premises	1 to 2 years

If ownership of the leased asset transfers to the Group by the end of the lease term or the cost reflects the exercise of a purchase option, depreciation is calculated using the estimated useful life of the asset.

(b) Lease liabilities

Lease liabilities are recognised at the commencement date of the lease at the present value of lease payments to be made over the lease term. The lease payments include fixed payments (including in-substance fixed payments) less any lease incentives receivable, variable lease payments that depend on an index or a rate, and amounts expected to be paid under residual value guarantees. The lease payments also include the exercise price of a purchase option reasonably certain to be exercised by the Group and payments of penalties for termination of a lease, if the lease term reflects the Group exercising the option to terminate the lease. The variable lease payments that do not depend on an index or a rate are recognised as an expense in the period in which the event or condition that triggers the payment occurs.

In calculating the present value of lease payments, the Group uses its incremental borrowing rate at the lease commencement date because the interest rate implicit in the lease is not readily determinable. After the commencement date, the amount of lease liabilities is increased to reflect the accretion of interest and reduced for the lease payments made. In addition, the carrying amount of lease liabilities is remeasured if there is a modification, a change in the lease term, a change in lease payments (e.g., a change to future lease payments resulting from a change in an index or rate) or a change in assessment of an option to purchase the underlying asset.

(c) Short-term leases

The Group applies the short-term lease recognition exemption to its short-term leases of warehouses and office premises (that is those leases that have a lease term of 12 months or less from the commencement date and do not contain a purchase option).

Lease payments on short-term leases are recognised as an expense on a straight-line basis over the lease term.

Investments and other financial assets

Initial recognition and measurement

Financial assets are classified, at initial recognition, as subsequently measured at amortised cost and fair value through profit or loss.

The classification of financial assets at initial recognition depends on the financial asset’s contractual cash flow characteristics and the Group’s business model for managing them. With the exception of trade receivables that do not contain a significant financing component or for which the Group has applied the practical expedient of not adjusting the effect of a significant financing component, the Group initially measures a financial asset at its fair

APPENDIX I

ACCOUNTANTS’ REPORT

value, plus in the case of a financial asset not at fair value through profit or loss, transaction costs. Trade receivables that do not contain a significant financing component or for which the Group has applied the practical expedient are measured at the transaction price determined under HKFRS 15 in accordance with the policies set out for “Revenue recognition” below.

In order for a financial asset to be classified and measured at amortised cost or fair value through other comprehensive income, it needs to give rise to cash flows that are solely payments of principal and interest (“SPPI”) on the principal amount outstanding. Financial assets with cash flows that are not SPPI are classified and measured at fair value through profit or loss, irrespective of the business model.

The Group’s business model for managing financial assets refers to how it manages its financial assets in order to generate cash flows. The business model determines whether cash flows will result from collecting contractual cash flows, selling the financial assets, or both. Financial assets classified and measured at amortised cost are held within a business model with the objective to hold financial assets in order to collect contractual cash flows, while financial assets classified and measured at fair value through other comprehensive income are held within a business model with the objective of both holding to collect contractual cash flows and selling. Financial assets which are not held within the aforementioned business models are classified and measured at fair value through profit or loss.

All regular way purchases and sales of financial assets are recognised on the trade date, that is, the date that the Group commits to purchase or sell the asset. Regular way purchases or sales are purchases or sales of financial assets that require delivery of assets within the period generally established by regulation or convention in the marketplace.

Subsequent measurement

The subsequent measurement of financial assets depends on their classification as follows:

Financial assets at amortised cost (debt instruments)

Financial assets at amortised cost are subsequently measured using the effective interest method and are subject to impairment. Gains and losses are recognised in profit or loss when the asset is derecognised, modified or impaired.

Financial assets at fair value through profit or loss

Financial assets at fair value through profit or loss are carried in the statement of financial position at fair value with net changes in fair value recognised in profit or loss.

Derecognition of financial assets

A financial asset (or, where applicable, a part of a financial asset or part of a group of similar financial assets) is primarily derecognised (i.e., removed from the Group’s consolidated statement of financial position) when:

- the rights to receive cash flows from the asset have expired; or
- the Group has transferred its rights to receive cash flows from the asset or has assumed an obligation to pay the received cash flows in full without material delay to a third party under a “pass-through” arrangement; and either (a) the Group has transferred substantially all the risks and rewards of the asset, or (b) the Group has neither transferred nor retained substantially all the risks and rewards of the asset, but has transferred control of the asset.

When the Group has transferred its rights to receive cash flows from an asset or has entered into a pass-through arrangement, it evaluates if, and to what extent, it has retained the risk and rewards of ownership of the asset. When it has neither transferred nor retained substantially all the risks and rewards of the asset nor transferred control of the asset, the Group continues to recognise the transferred asset to the extent of the Group’s continuing involvement. In that case, the Group also recognises an associated liability. The transferred asset and the associated liability are measured on a basis that reflects the rights and obligations that the Group has retained.

Continuing involvement that takes the form of a guarantee over the transferred asset is measured at the lower of the original carrying amount of the asset and the maximum amount of consideration that the Group could be required to repay.

APPENDIX I

ACCOUNTANTS’ REPORT

Impairment of financial assets

The Group recognises an allowance for expected credit losses (“ECLs”) for all debt instruments not held at fair value through profit or loss. ECLs are based on the difference between the contractual cash flows due in accordance with the contract and all the cash flows that the Group expects to receive, discounted at an approximation of the original effective interest rate. The expected cash flows will include cash flows from the sale of collateral held or other credit enhancements that are integral to the contractual terms.

General approach

ECLs are recognised in two stages. For credit exposures for which there has not been a significant increase in credit risk since initial recognition, ECLs are provided for credit losses that result from default events that are possible within the next 12 months (a 12-month ECL). For those credit exposures for which there has been a significant increase in credit risk since initial recognition, a loss allowance is required for credit losses expected over the remaining life of the exposure, irrespective of the timing of the default (a lifetime ECL).

At the end of each of the Relevant Periods, the Group assesses whether the credit risk on a financial instrument has increased significantly since initial recognition. When making the assessment, the Group compares the risk of a default occurring on the financial instrument as at the end of each of the Relevant Periods with the risk of a default occurring on the financial instrument as at the date of initial recognition and considers reasonable and supportable information that is available without undue cost or effort, including historical and forward-looking information.

The Group considers a financial asset in default when contractual payments are 90 days past due. However, in certain cases, the Group may also consider a financial asset to be in default when internal or external information indicates that the Group is unlikely to receive the outstanding contractual amounts in full before taking into account any credit enhancements held by the Group. A financial asset is written off when there is no reasonable expectation of recovering the contractual cash flows.

Financial assets at amortised cost are subject to impairment under the general approach and they are classified within the following stages for measurement of ECLs except for trade receivables and finance lease receivables which apply the simplified approach as detailed below.

- Stage 1 – Financial instruments for which credit risk has not increased significantly since initial recognition and for which the loss allowance is measured at an amount equal to 12-month ECLs
- Stage 2 – Financial instruments for which credit risk has increased significantly since initial recognition but that are not credit-impaired financial assets and for which the loss allowance is measured at an amount equal to lifetime ECLs
- Stage 3 – Financial assets that are credit-impaired at the end of each of the Relevant Periods (but that are not purchased or originated credit-impaired) and for which the loss allowance is measured at an amount equal to lifetime ECLs

Simplified approach

For trade receivables that do not contain a significant financing component or when the Group applies the practical expedient of not adjusting the effect of a significant financing component, the Group applies the simplified approach in calculating ECLs. Under the simplified approach, the Group does not track changes in credit risk, but instead recognises a loss allowance based on lifetime ECLs at the end of each of the Relevant Periods. The Group has established a provision matrix that is based on market historical credit loss experience, adjusted for forward-looking factors specific to the debtors and the economic environment.

Financial liabilities

Initial recognition and measurement

Financial liabilities are classified, at initial recognition, as loans and borrowings or payables, as appropriate.

All financial liabilities are recognised initially at fair value and, in the case of loans and borrowings and payables, net of directly attributable transaction costs.

The Group’s financial liabilities include trade payables, other payables and accruals, lease liabilities and an interest-bearing bank borrowing.

APPENDIX I

ACCOUNTANTS’ REPORT

Subsequent measurement

The subsequent measurement of financial liabilities depends on their classification as follows:

Financial liabilities at amortised cost (loans and borrowings and payables)

After initial recognition, interest-bearing bank borrowings and payables are subsequently measured at amortised cost, using the effective interest rate method unless the effect of discounting would be immaterial, in which case they are stated at cost. Gains and losses are recognised in profit or loss when the liabilities are derecognised as well as through the effective interest rate amortisation process.

Amortised cost is calculated by taking into account any discount or premium on acquisition and fees or costs that are an integral part of the effective interest rate. The effective interest rate amortisation is included in finance costs in profit or loss.

Derecognition of financial liabilities

A financial liability is derecognised when the obligation under the liability is discharged or cancelled, or expires.

When an existing financial liability is replaced by another from the same lender on substantially different terms, or the terms of an existing liability are substantially modified, such an exchange or modification is treated as a derecognition of the original liability and a recognition of a new liability, and the difference between the respective carrying amounts is recognised in profit or loss.

Offsetting of financial instruments

Financial assets and financial liabilities are offset and the net amount is reported in the statement of financial position if there is a currently enforceable legal right to offset the recognised amounts and there is an intention to settle on a net basis, or to realise the assets and settle the liabilities simultaneously.

Inventories

Inventories are stated at the lower of cost and net realisable value. Cost is determined on the weighted average basis and, in the case of work in progress and finished goods, comprises direct materials, direct labour and an appropriate proportion of overheads. Net realisable value is based on estimated selling prices less any estimated costs to be incurred to completion and disposal.

Cash and cash equivalents

For the purpose of the consolidated statement of cash flows, cash and cash equivalents comprise cash on hand and demand deposits, and short term highly liquid investments that are readily convertible into known amounts of cash, are subject to an insignificant risk of changes in value, and have a short maturity of generally within three months when acquired and form an integral part of the Group’s cash management.

For the purpose of the consolidated statement of financial position, cash and cash equivalents comprise cash on hand and at banks which are not restricted as to use.

Provisions

A provision is recognised when a present obligation (legal or constructive) has arisen as a result of a past event and it is probable that a future outflow of resources will be required to settle the obligation, provided that a reliable estimate can be made of the amount of the obligation.

When the effect of discounting is material, the amount recognised for a provision is the present value at the end of each of the Relevant Periods of the future expenditures expected to be required to settle the obligation. The increase in the discounted present value amount arising from the passage of time is included in finance costs in profit or loss.

APPENDIX I

ACCOUNTANTS' REPORT

The Group provides for warranties in relation to the sale of certain products for general repairs of defects occurring during the warranty period. Provisions for these assurance-type warranties granted by the Group are recognised based on sales volume and past experience of the level of repairs and returns, discounted to their present values as appropriate.

Income tax

Income tax comprises current and deferred tax. Income tax relating to items recognised outside profit or loss is recognised outside profit or loss, either in other comprehensive income or directly in equity.

Current tax assets and liabilities are measured at the amount expected to be recovered from or paid to the taxation authorities, based on tax rates (and tax laws) that have been enacted or substantively enacted by the end of each of the Relevant Periods, taking into consideration interpretations and practices prevailing in the countries in which the Group operates.

Deferred tax is provided, using the liability method, on all temporary differences at the end of each of the Relevant Periods between the tax bases of assets and liabilities and their carrying amounts for financial reporting purposes.

Deferred tax liabilities are recognised for all taxable temporary differences, except:

- when the deferred tax liability arises from the initial recognition of an asset or liability in a transaction that is not a business combination and, at the time of the transaction, affects neither the accounting profit nor taxable profit or loss; and
- in respect of taxable temporary differences associated with investments in subsidiaries, associates and joint ventures, when the timing of the reversal of the temporary differences can be controlled and it is probable that the temporary differences will not reverse in the foreseeable future.

Deferred tax assets are recognised for all deductible temporary differences, and the carryforward of unused tax credits and any unused tax losses. Deferred tax assets are recognised to the extent that it is probable that taxable profit will be available against which the deductible temporary differences, and the carryforward of unused tax credits and unused tax losses can be utilised, except:

- when the deferred tax asset relating to the deductible temporary differences arises from the initial recognition of an asset or liability in a transaction that is not a business combination and, at the time of the transaction, affects neither the accounting profit nor taxable profit or loss; and
- in respect of deductible temporary differences associated with investments in subsidiaries, deferred tax assets are only recognised to the extent that it is probable that the temporary differences will reverse in the foreseeable future and taxable profit will be available against which the temporary differences can be utilised.

The carrying amount of deferred tax assets is reviewed at the end of each of the Relevant Periods and reduced to the extent that it is no longer probable that sufficient taxable profit will be available to allow all or part of the deferred tax asset to be utilised. Unrecognised deferred tax assets are reassessed at the end of each of the Relevant Periods and are recognised to the extent that it has become probable that sufficient taxable profit will be available to allow all or part of the deferred tax asset to be recovered.

Deferred tax assets and liabilities are measured at the tax rates that are expected to apply to the period when the asset is realised or the liability is settled, based on tax rates (and tax laws) that have been enacted or substantively enacted by the end of each of the Relevant Periods.

Deferred tax assets and deferred tax liabilities are offset if and only if the Group has a legally enforceable right to set off current tax assets and current tax liabilities and the deferred tax assets and deferred tax liabilities relate to income taxes levied by the same taxation authority on either the same taxable entity or different taxable entities which intend either to settle current tax liabilities and assets on a net basis, or to realise the assets and settle the liabilities simultaneously, in each future period in which significant amounts of deferred tax liabilities or assets are expected to be settled or recovered.

APPENDIX I

ACCOUNTANTS’ REPORT

Government grants

Government grants are recognised at their fair value where there is reasonable assurance that the grant will be received and all attaching conditions will be complied with. When the grant relates to an expense item, it is recognised as income on a systematic basis over the periods that the costs, for which it is intended to compensate, are expensed.

Where the grant relates to an asset, the fair value is credited to a deferred income account and is released to profit or loss over the expected useful life of the relevant asset by equal annual instalments or deducted from the carrying amount of the asset and released to profit or loss by way of a reduced depreciation charge.

Revenue recognition

Revenue from contracts with customers

Revenue from contracts with customers is recognised when control of goods or services is transferred to the customers at an amount that reflects the consideration to which the Group expects to be entitled in exchange for those goods or services.

When the contract contains a financing component which provides the customer with a significant benefit of financing the transfer of goods or services to the customer for more than one year, revenue is measured at the present value of the amount receivable, discounted using the discount rate that would be reflected in a separate financing transaction between the Group and the customer at contract inception. When the contract contains a financing component which provides the Group with a significant financial benefit for more than one year, revenue recognised under the contract includes the interest expense accreted on the contract liability under the effective interest method. For a contract where the period between the payment by the customer and the transfer of the promised goods or services is one year or less, the transaction price is not adjusted for the effects of a significant financing component, using the practical expedient in HKFRS 15.

Sale of medical devices and consumables

Revenue from the sale of medical devices and consumables is recognised at the point in time when control of the asset is transferred to the customer, generally on acceptance of the products.

Other income

Interest income is recognised on an accrual basis using the effective interest method by applying the rate that exactly discounts the estimated future cash receipts over the expected life of the financial instrument or a shorter period, when appropriate, to the net carrying amount of the financial asset.

Contract liabilities

A contract liability is recognised when a payment is received or a payment is due (whichever is earlier) from a customer before the Group transfers the related goods. Contract liabilities are recognised as revenue when the Group performs under the contract (i.e., transfers control of the related goods to the customer).

Refund liabilities

A refund liability is recognised for the obligation to refund some or all of the consideration received (or receivable) from a customer and is measured at the amount the Group ultimately expects it will have to return to the customer. The Group updates its estimates of refund liabilities (and the corresponding change in the transaction price) at the end of each reporting period.

Share-based payments

The Company operates share award plans for the purpose of providing incentives and rewards to eligible participants who contribute to the success of the Group’s operations. Employees (including directors) of the Group receive remuneration in the form of share-based payments, whereby employees render services as consideration for equity instruments (“equity-settled transactions”).

APPENDIX I

ACCOUNTANTS’ REPORT

The cost of equity-settled transactions with employees is measured by reference to the fair value at the date at which they are granted. The fair value is determined by an external valuer by using the discounted cash flow method, back-solve method and equity allocation based on the option pricing model (“OPM”).

The cost of equity-settled transactions is recognised in expense, together with a corresponding increase in equity, over the period in which the performance and/or service conditions are fulfilled. The cumulative expense recognised for equity-settled transactions at the end of each of the Relevant Periods until the vesting date reflects the extent to which the vesting period has expired and the Group’s best estimate of the number of equity instruments that will ultimately vest. The charge or credit to profit or loss for a period represents the movement in the cumulative expense recognised as at the beginning and end of that period.

Service are not taken into account when determining the grant date fair value of awards, but the likelihood of the conditions being met is assessed as part of the Group’s best estimate of the number of equity instruments that will ultimately vest.

Where the terms of an equity-settled award are modified, as a minimum an expense is recognised as if the terms had not been modified, if the original terms of the award are met. In addition, an expense is recognised for any modification that increases the total fair value of the share-based payments, or is otherwise beneficial to the employee as measured at the date of modification.

Where a modified vesting period is shorter than the original vesting period, all of the expense relating to both the original and modified elements of the award should be recognised by the end of the modified vesting period as no services will be rendered beyond that point.

Other employee benefits

Pension scheme

The employees of the Group’s subsidiary which operates in Mainland China are required to participate in a central pension scheme operated by the local government. The subsidiary is required to contribute a certain percentage of its payroll costs to the central pension scheme. The contributions are charged to profit or loss as they become payable in accordance with the rules and practice of the central pension scheme.

Termination benefits

Termination benefits are recognised at the earlier of when the Group can no longer withdraw the offer of those benefits and when the Group recognises restructuring costs involving the payment of termination benefits.

Borrowing costs

All borrowing costs are expensed in the period in which they are incurred. Borrowing costs consist of interest that an entity incurs in connection with the borrowing of funds.

Dividends

Final dividends are recognised as a liability when they are approved by the shareholders in a general meeting.

3. SIGNIFICANT ACCOUNTING JUDGEMENTS AND ESTIMATES

The preparation of the Group’s Historical Financial Information requires management to make judgements, estimates and assumptions that affect the reported amounts of revenues, expenses, assets and liabilities, and their accompanying disclosures, and the disclosure of contingent liabilities. Uncertainty about these assumptions and estimates could result in outcomes that could require a material adjustment to the carrying amounts of the assets or liabilities affected in the future.

Judgements

In the process of applying the Group’s accounting policies, management has made the following judgements, apart from those involving estimations, which have the most significant effect on the amounts recognised in the Historical Financial Information.

APPENDIX I

ACCOUNTANTS’ REPORT

Research and development costs

Research and development costs are expensed in accordance with the accounting policy for research and development costs in note 2.3 to the Historical Financial Information. Determining the amounts to be capitalised or expensed requires management to make assumptions and judgements regarding the technical feasibility of completing the intangible asset, future economic benefits and so forth.

Estimation uncertainty

The key assumptions concerning the future and other key sources of estimation uncertainty at the end of each of the Relevant Periods, that have a significant risk of causing a material adjustment to the carrying amounts of assets and liabilities within the next financial year, are described below.

Provision for expected credit losses of trade receivables

The Group uses a provision matrix to calculate ECLs for trade receivables. The provision rates are based on ageing for groupings of various customer segments that have similar loss patterns (i.e., by customer type).

The provision matrix is initially based on the Group’s historical observed default rates. The Group calibrates the matrix to adjust the historical credit loss experience with forward-looking information. For instance, if forecast economic conditions (i.e., gross domestic product) are expected to deteriorate over the next year which can lead to an increased number of defaults in the medical industry sector, the historical default rates are adjusted. At the end of each of the Relevant Periods, the historical observed default rates are updated and changes in the forward-looking estimates are analysed.

The assessment of the correlation between historical observed default rates, forecast economic conditions and ECLs is a significant estimate. The amount of ECLs is sensitive to changes in circumstances and of forecast economic conditions. The Group’s historical credit loss experience and forecast of economic conditions may also not be representative of customers’ actual default in the future. The information about the ECLs on the Group’s trade receivables is disclosed in note 17 to the Historical Financial Information.

Useful lives of intangible assets

The Group’s finite life intangible assets primarily represent patents. These intangible assets are amortised on a straight-line basis over their useful economic lives, which are estimated to be the patent life. Additional amortisation is recognised if the estimated useful lives of patents are different from the previous estimation. Useful lives are reviewed at the end of each of the Relevant Periods based on changes in circumstances.

Impairment of non-financial assets

The Group assesses whether there are any indicators of impairment for all non-financial assets (including the right-of-use assets) at the end of each of the Relevant Periods. Other non-financial assets are tested for impairment when there are indicators that the carrying amounts may not be recoverable. An impairment exists when the carrying value of an asset or a cash-generating unit exceeds its recoverable amount, which is the higher of its fair value less costs of disposal and its value in use. The calculation of the fair value less costs of disposal is based on available data from binding sales transactions in an arm’s length transaction of similar assets or observable market prices less incremental costs for disposing of the asset. When value in use calculations are undertaken, management must estimate the expected future cash flows from the asset or cash-generating unit and choose a suitable discount rate in order to calculate the present value of those cash flows.

Estimation of the fair value of financial assets at fair value through profit or loss

Fair value of investments in wealth management products, unit trust and structured deposits, in the absence of an active market, is estimated by using appropriate valuation techniques. Such valuations are based on certain assumptions about future cash flows, liquidity risks associated with the instruments, which are subject to uncertainty and might materially differ from the actual results. The fair value of investments in wealth management products, unit trust and structured deposits at 31 December 2019 and 2020 amounted to RMB123,495,000 and RMB105,192,000, respectively. Further details are included in note 20 to the Historical Financial Information.

APPENDIX I

ACCOUNTANTS’ REPORT

Fair value measurement of share-based payments

The Group has set up share award plans and granted shares to the Company’s directors and the Group’s employees. The fair value is determined by an external valuer by using the discounted cash flow method, back-solve method and equity allocation based on the OPM.

Significant estimates on assumptions, including the expected volatility and risk-free interest rate, are made by the board of directors of the Company. Further details are included in note 28 to the Historical Financial Information.

Recognition of deferred tax assets

Deferred tax assets are recognised for unused tax losses to the extent that it is probable that taxable profit will be available against which the losses can be utilised. Significant management judgement is required to determine the amount of deferred tax assets that can be recognised, based upon the likely timing and level of future taxable profits together with future tax planning strategies. Deferred tax assets have not been recognised in respect of these losses as they have arisen in companies that have been loss-making for some time and it is not considered probable that taxable profits will be available against which the tax losses can be utilised. Further details are included in note 10 to the Historical Financial Information.

4. OPERATING SEGMENT INFORMATION

For management purposes, the Group is not organised into business units based on their products and only has one reportable operating segment. Management monitors the operating results of the Group’s operating segment as a whole for the purpose of making decisions about resource allocation and performance assessment.

Geographical information

(a) Revenue from external customers

	Year ended 31 December	Year ended 31 December
	2019	2020
	<i>RMB’000</i>	<i>RMB’000</i>
Mainland China	43,231	60,111
Other countries/regions	8,632	15,166
	<u>51,863</u>	<u>75,277</u>

The revenue information above is based on the locations of the customers.

(b) Non-current assets

The Group’s non-current assets are all located in Mainland China.

Information about major customers

No revenue from the Group’s sales to a single customer amounted to 10% or more of the Group’s total revenue during the Relevant Periods.

APPENDIX I

ACCOUNTANTS’ REPORT

5. REVENUE, OTHER INCOME AND GAINS

An analysis of revenue is as follows:

	Year ended 31 December	Year ended 31 December
	2019	2020
	<i>RMB’000</i>	<i>RMB’000</i>
<i>Revenue from contracts with customers</i>		
Sale of medical devices and consumables	51,863	75,277

Revenue from contracts with customers

(a) Disaggregated revenue information

	Year ended 31 December	Year ended 31 December
	2019	2020
	<i>RMB’000</i>	<i>RMB’000</i>
Geographical markets		
Mainland China	43,231	60,111
Other countries/regions	8,632	15,166
	<u>51,863</u>	<u>75,277</u>
Timing of revenue recognition		
Goods transferred at a point in time	<u>51,863</u>	<u>75,277</u>

The following table shows the amounts of revenue recognised during the Relevant Periods that were included in the contract liabilities at the beginning of the Relevant Periods and recognised from performance obligations satisfied in previous periods:

	Year ended 31 December	Year ended 31 December
	2019	2020
	<i>RMB’000</i>	<i>RMB’000</i>
Revenue recognised that was included in contract liabilities at the beginning of the year:		
Sale of medical devices and consumables	<u>2,687</u>	<u>5,282</u>

APPENDIX I

ACCOUNTANTS’ REPORT

(b) Performance obligations

Information about the Group’s performance obligations is summarised below:

Sale of medical devices and consumables

The performance obligation is satisfied upon acceptance of the products by the customers and payment is generally due within 3 months to 9 months.

An analysis of other income and gains is as follows:

	Year ended 31 December	Year ended 31 December
	2019	2020
	<i>RMB’000</i>	<i>RMB’000</i>
<u>Other income</u>		
Government grants*	2,246	19,243
Bank interest income	848	2,376
Investment income from financial assets at fair value through profit or loss	5,374	5,768
Others	–	49
	<u>8,468</u>	<u>27,436</u>
<u>Gains</u>		
Gain on disposal of items of property, plant and equipment	62	227
Foreign exchange gains, net	186	–
	<u>248</u>	<u>227</u>
	<u><u>8,716</u></u>	<u><u>27,663</u></u>

* The government grants mainly represent subsidies received from the local governments for compensating expenses arising from research activities and rewarding research and developments costs and capital expenditure incurred for certain projects.

APPENDIX I

ACCOUNTANTS’ REPORT

6. LOSS BEFORE TAX

The Group’s loss before tax is arrived at after charging/(crediting):

		Year ended 31 December	Year ended 31 December
		2019	2020
	Notes	RMB’000	RMB’000
Cost of inventories sold		27,780	38,733
Research and development costs		50,060	82,009
Depreciation of property, plant and equipment	13	1,106	3,287
Depreciation of right-of-use assets	14(a)	867	493
Amortisation of intangible assets*	15	1,457	1,704
Impairment of trade receivables, net	17	423	188
Write-down of inventories to net realisable value**		174	106
Government grants		(2,246)	(19,243)
Bank interest income		(848)	(2,376)
Investment income from financial assets at fair value through profit or loss		(5,374)	(5,768)
Gain on disposal of items of property, plant and equipment		(62)	(227)
Lease payments not included in the measurement of lease liabilities	14(c)	186	396
Foreign exchange differences, net		(186)	2,107
Auditor’s remuneration		19	22
Employee benefit expense (excluding directors’ and chief executive’s remuneration (note 8)):			
Wages and salaries		29,870	39,504
Pension scheme contributions		1,326	153
Staff welfare expenses		1,937	2,160
Equity-settled share award expense		632	45,651
		33,765	87,468

* The amortisation of intangible assets for the Relevant Periods is included in “Administrative expenses” and “Research and development costs” in the consolidated statements of profit or loss and other comprehensive income.

** The write-down of inventories to net realisable value for the Relevant Periods is included in “Cost of sales” in the consolidated statements of profit or loss and other comprehensive income.

APPENDIX I

ACCOUNTANTS’ REPORT

7. FINANCE COSTS

An analysis of finance costs is as follows:

	Year ended 31 December	Year ended 31 December
	2019	2020
	<i>RMB’000</i>	<i>RMB’000</i>
Interest on a bank borrowing	303	299
Interest on lease liabilities (<i>note 14(c)</i>)	8	9
	<u>311</u>	<u>308</u>

8. DIRECTORS’, CHIEF EXECUTIVE’S AND SUPERVISORS’ REMUNERATION

The remuneration of each of the Company’s director is set out below:

	Year ended 31 December	Year ended 31 December
	2019	2020
	<i>RMB’000</i>	<i>RMB’000</i>
Fees	–	30
Other emoluments:		
Salaries, bonuses, allowances and benefits in kind	534	2,525
Pension scheme contributions	18	3
Equity-settled share award expense	56,932	65,525
	<u>57,484</u>	<u>68,053</u>

(a) Independent non-executive directors

The fees paid to independent non-executive directors during the Relevant Periods were as follows:

	Year ended 31 December	Year ended 31 December
	2019	2020
	<i>RMB’000</i>	<i>RMB’000</i>
Dr. Li Lihua ⁽¹⁾	–	10
Ms. Gao Jian ⁽¹⁾	–	10
Ms. Wang Chunfeng ⁽¹⁾	–	10
Mr. Ho Kin Cheong Kelvin ⁽²⁾	–	–
	<u>–</u>	<u>30</u>

(1) Dr. Li Lihua, Ms. Gao Jian and Ms. Wang Chunfeng were appointed as independent directors in October 2020 and re-designated as independent non-executive directors in April 2021.

(2) Mr. Ho Kin Cheong Kelvin was appointed as an independent non-executive director in April 2021.

There were no other emoluments payable to the independent non-executive directors during the Relevant Periods.

APPENDIX I

ACCOUNTANTS’ REPORT

(b) Executive directors, non-executive directors, the chief executive and supervisors

Executive directors

	Salaries, bonuses, allowances and benefits in kind	Pension scheme contributions	Equity-settled share award expense	Total remuneration
	<i>RMB'000</i>	<i>RMB'000</i>	<i>RMB'000</i>	<i>RMB'000</i>
Year ended 31 December 2019				
Dr. Zheng Pan (chief executive) ⁽³⁾	362	9	56,932	57,303
Ms. Xu Fangling ⁽³⁾	172	9	–	181
	<u>534</u>	<u>18</u>	<u>56,932</u>	<u>57,484</u>
Year ended 31 December 2020				
Dr. Zheng Pan (chief executive) ⁽³⁾	904	1	45,965	46,870
Ms. Liu Xiu ⁽⁴⁾	210	–	4,071	4,281
Ms. Xu Fangling ⁽³⁾	382	1	2,036	2,419
Dr. Yu Fei ⁽⁴⁾	1,029	1	13,453	14,483
	<u>2,525</u>	<u>3</u>	<u>65,525</u>	<u>68,053</u>

(3) Dr. Zheng Pan and Ms. Xu Fangling were directors during the Relevant Periods and were re-designated as executive directors in April 2021.

(4) Dr. Yu Fei and Ms. Liu Xiu were appointed as directors in October 2020 and re-designated as executive directors in April 2021.

Non-executive directors

Mr. Hu Xubo was a director during the Relevant Periods and was re-designated as a non-executive director in April 2021. Ms. Gao Yun was appointed as a director in May 2020 and re-designated as a non-executive director in April 2021. There were no fees and other emoluments payable to non-executive directors during the Relevant Periods.

Supervisors

	Salaries, bonuses, allowances and benefits in kind	Pension scheme contributions	Equity-settled share award expense	Total remuneration
	<i>RMB'000</i>	<i>RMB'000</i>	<i>RMB'000</i>	<i>RMB'000</i>
Year ended 31 December 2020				
Mr. Li Zhenhua ⁽⁵⁾	349	1	2,000	2,350
Mr. Zhao Zhiheng ⁽⁵⁾	257	1	958	1,216
Mr. Lv Cheng ⁽⁵⁾	–	–	–	–
	<u>606</u>	<u>2</u>	<u>2,958</u>	<u>3,566</u>

(5) Mr. Li Zhenhua, Mr. Zhao Zhiheng and Mr. Lv Cheng were appointed as supervisors in October 2020.

APPENDIX I

ACCOUNTANTS’ REPORT

During the Relevant Periods, Dr. Zheng Pan, Dr. Yu Fei, Ms. Liu Xiu, Ms. Xu Fangling, Mr. Li Zhenhua and Mr. Zhao Zhiheng were granted shares in respect of their services to the Group, further details of which are included in the disclosures in note 28 to the Historical Financial Information. The fair value of such share awards, which has been recognised in profit or loss over the vesting period, was determined as at the date of grant and the amounts included in the Historical Financial Information for the Relevant Periods are included in the above directors’ remuneration disclosures.

There was no arrangement under which a director or the chief executive waived or agreed to waive any remuneration during the Relevant Periods. During the Relevant Periods, no remuneration was paid by the Group to the directors as an inducement to join or upon joining the Group or as compensation for loss of office.

9. FIVE HIGHEST PAID EMPLOYEES

The five highest paid employees during the Relevant Periods included one and two directors, respectively, details of whose remuneration are set out in note 8 above. Details of the remuneration for the remaining four and three highest paid employees who are neither a director nor chief executive of the Company during the Relevant Periods are as follows:

	Year ended 31 December	Year ended 31 December
	2019	2020
	<i>RMB’000</i>	<i>RMB’000</i>
Salaries, bonuses, allowances and benefits in kind	3,921	1,574
Pension scheme contributions	36	3
Equity-settled share award expense	112	20,226
	<u>4,069</u>	<u>21,803</u>

The number of non-director and non-chief executive highest paid employees whose remuneration fell within the following bands is as follows:

	Number of employees	
	Year ended 31 December	Year ended 31 December
	2019	2020
Nil to HK\$1,000,000	2	–
HK\$1,000,000 to HK\$2,000,000	2	–
HK\$5,000,000 to HK\$6,000,000	–	1
HK\$6,000,000 to HK\$7,000,000	–	1
HK\$11,000,000 to HK\$12,000,000	–	1
	<u>4</u>	<u>3</u>

During the Relevant Periods, share awards were granted to certain non-director and non-chief executive highest paid employees in respect of their services to the Group, further details of which are included in the disclosures in note 28 to the Historical Financial Information. The fair value of such share awards, which has been recognised in profit or loss over the vesting period, was determined as at the date of grant and the amounts included in the Historical Financial Information for the Relevant Periods are included in the above non-director and non-chief executive highest paid employees’ remuneration disclosures.

10. INCOME TAX

The Group is subject to income tax on an entity basis on profits arising in or derived from the jurisdictions in which members of the Group are domiciled and operate.

APPENDIX I

ACCOUNTANTS’ REPORT

PRC

Pursuant to the Corporate Income Tax Law of the PRC and the respective regulations (the “CIT Law”), the companies which operates in Mainland China is subject to CIT at a rate of 25% on the taxable income. A preferential tax treatment is available to the Company, since it was recognised as a High and New Technology Enterprise on 30 November 2018, and was entitled to a preferential tax rate of 15% during the Relevant Periods.

The income tax expense of the Group during the Relevant Periods is analysed as follows:

	Year ended 31 December	Year ended 31 December
	2019	2020
	<i>RMB’000</i>	<i>RMB’000</i>
Current tax:		
Charge for the year	–	–
Deferred tax	–	–
	<u>–</u>	<u>–</u>
Total tax expense for the year	<u>–</u>	<u>–</u>

A reconciliation of the tax expense applicable to loss before tax at the statutory rate to the tax expense at the effective tax rate is as follows:

	Year ended 31 December	Year ended 31 December
	2019	2020
	<i>RMB’000</i>	<i>RMB’000</i>
Loss before tax	(78,614)	(121,250)
	<u>(78,614)</u>	<u>(121,250)</u>
Tax at the statutory tax rate of 25% in Mainland China	(19,654)	(30,313)
Preferential tax rates enacted by local authority	7,861	12,258
Expenses not deductible for tax	8,943	17,577
Additional deductible allowance for research and development costs	(2,323)	(2,232)
Temporary differences and tax losses not recognised	5,173	2,710
	<u>–</u>	<u>–</u>
Tax charge at the Group’s effective tax rate	<u>–</u>	<u>–</u>

Deferred tax assets have not been recognised in respect of the following items:

	As at 31 December	As at 31 December
	2019	2020
	<i>RMB’000</i>	<i>RMB’000</i>
Tax losses	138,458	151,410
Deductible temporary differences	8,392	14,072
	<u>146,850</u>	<u>165,482</u>

APPENDIX I

ACCOUNTANTS’ REPORT

The Group had tax losses arising in Mainland China of RMB138,458,000 and RMB151,410,000 as at 31 December 2019 and 2020, respectively. The tax losses will expire in the following years:

	As at 31 December	As at 31 December
	2019	2020
	<i>RMB’000</i>	<i>RMB’000</i>
2023	10,583	10,583
2024	14,304	14,304
2025	8,694	9,541
2026	9,757	9,757
2027	33,947	33,947
2028	28,146	28,146
2029	33,027	33,027
2030	–	12,105
	<u>138,458</u>	<u>151,410</u>

Deferred tax assets have not been recognised in respect of these losses as it is not considered probable that taxable profits will be available against which the tax losses can be utilised.

11. DIVIDENDS

No dividend has been paid or declared by the Company in respect of the Relevant Periods.

12. LOSS PER SHARE ATTRIBUTABLE TO ORDINARY EQUITY HOLDERS OF THE PARENT

The calculation of the basic loss per share amounts is based on the loss attributable to ordinary equity holders of the parent, and the weighted average number of ordinary shares of 281,665,237 and 306,401,310 in issue during the Relevant Periods, respectively, on the assumption that paid-in capital had been fully converted into share capital at the same conversion ratio of 1:1 as upon transformation into a joint stock company and the transfer of share premium to share capital had been completed on 1 January 2019.

No adjustment has been made to the basic loss per share amounts presented for the Relevant Periods in respect of a dilution as the impact of the share award outstanding had an anti-dilutive effect on the basic loss per share amounts presented.

13. PROPERTY, PLANT AND EQUIPMENT

Group and Company

	Buildings	Machinery and equipment	Computer and office equipment	Motor vehicles	Construction in progress	Total
	<i>RMB’000</i>	<i>RMB’000</i>	<i>RMB’000</i>	<i>RMB’000</i>	<i>RMB’000</i>	<i>RMB’000</i>
31 December 2019						
At 1 January 2019:						
Cost	–	5,942	1,524	218	11,008	18,692
Accumulated depreciation	–	(2,577)	(1,058)	(207)	–	(3,842)
Net carrying amount	<u>–</u>	<u>3,365</u>	<u>466</u>	<u>11</u>	<u>11,008</u>	<u>14,850</u>

APPENDIX I

ACCOUNTANTS’ REPORT

	Buildings	Machinery and equipment	Computer and office equipment	Motor vehicles	Construction in progress	Total
	<i>RMB'000</i>	<i>RMB'000</i>	<i>RMB'000</i>	<i>RMB'000</i>	<i>RMB'000</i>	<i>RMB'000</i>
At 1 January 2019, net of accumulated depreciation	–	3,365	466	11	11,008	14,850
Additions	–	1,682	186	–	27,729	29,597
Depreciation provided during the year (<i>note 6</i>)	–	(922)	(184)	–	–	(1,106)
	<u>–</u>	<u>3,365</u>	<u>466</u>	<u>11</u>	<u>11,008</u>	<u>14,850</u>
At 31 December 2019, net of accumulated depreciation	<u>–</u>	<u>4,125</u>	<u>468</u>	<u>11</u>	<u>38,737</u>	<u>43,341</u>
At 31 December 2019:						
Cost	–	7,450	1,710	218	38,737	48,115
Accumulated depreciation	–	(3,325)	(1,242)	(207)	–	(4,774)
	<u>–</u>	<u>7,450</u>	<u>1,710</u>	<u>218</u>	<u>38,737</u>	<u>48,115</u>
Net carrying amount	<u>–</u>	<u>4,125</u>	<u>468</u>	<u>11</u>	<u>38,737</u>	<u>43,341</u>
	<u>–</u>	<u>4,125</u>	<u>468</u>	<u>11</u>	<u>38,737</u>	<u>43,341</u>
31 December 2020						
At 1 January 2020:						
Cost	–	7,450	1,710	218	38,737	48,115
Accumulated depreciation	–	(3,325)	(1,242)	(207)	–	(4,774)
	<u>–</u>	<u>7,450</u>	<u>1,710</u>	<u>218</u>	<u>38,737</u>	<u>48,115</u>
Net carrying amount	<u>–</u>	<u>4,125</u>	<u>468</u>	<u>11</u>	<u>38,737</u>	<u>43,341</u>
	<u>–</u>	<u>4,125</u>	<u>468</u>	<u>11</u>	<u>38,737</u>	<u>43,341</u>
At 1 January 2020, net of accumulated depreciation	–	4,125	468	11	38,737	43,341
Additions	4,860	3,210	580	4	17,420	26,074
Disposals	–	(143)	(20)	–	–	(163)
Depreciation provided during the year (<i>note 6</i>)	(1,446)	(1,616)	(225)	–	–	(3,287)
Transfers	49,437	6,605	–	–	(56,042)	–
	<u>52,851</u>	<u>12,181</u>	<u>803</u>	<u>15</u>	<u>115</u>	<u>65,965</u>
At 31 December 2020, net of accumulated depreciation	<u>52,851</u>	<u>12,181</u>	<u>803</u>	<u>15</u>	<u>115</u>	<u>65,965</u>
At 31 December 2020:						
Cost	54,297	16,715	1,786	222	115	73,135
Accumulated depreciation	(1,446)	(4,534)	(983)	(207)	–	(7,170)
	<u>52,851</u>	<u>12,181</u>	<u>803</u>	<u>15</u>	<u>115</u>	<u>65,965</u>
Net carrying amount	<u>52,851</u>	<u>12,181</u>	<u>803</u>	<u>15</u>	<u>115</u>	<u>65,965</u>
	<u>52,851</u>	<u>12,181</u>	<u>803</u>	<u>15</u>	<u>115</u>	<u>65,965</u>

14. LEASES

The Group and the Company as a lessee

The Group has lease contracts for warehouses and office premises used in its operations. Lump sum payments were made upfront to acquire the leasehold land from the government with lease periods of 50 years, and no ongoing payments will be made under the terms of these land leases. Leases of warehouses and office premises generally have lease terms between 1 and 2 years. Generally, the Group is restricted from assigning and subleasing the leased assets outside the Group. There are no lease contracts that include extension and termination options and variable lease payments.

APPENDIX I

ACCOUNTANTS’ REPORT

(a) Right-of-use assets

The carrying amounts of the Group’s right-of-use assets and the movements during the Relevant Periods are as follows:

	Leasehold land	Office premises and warehouses	Total
	<i>RMB’000</i>	<i>RMB’000</i>	<i>RMB’000</i>
As at 1 January 2019	7,092	899	7,991
Depreciation charge	(148)	(719)	(867)
As at 31 December 2019 and 1 January 2020	<u>6,944</u>	<u>180</u>	<u>7,124</u>
Additions	–	331	331
Depreciation charge	(148)	(345)	(493)
As at 31 December 2020	<u>6,796</u>	<u>166</u>	<u>6,962</u>

(b) Lease liabilities

The carrying amounts of lease liabilities and the movements during the Relevant Periods are as follows:

	Year ended 31 December 2019	Year ended 31 December 2020
	<i>RMB’000</i>	<i>RMB’000</i>
Carrying amount at 1 January	725	–
New leases	–	331
Accretion of interest recognised during the year	8	9
Payments	(733)	(214)
Carrying amount at the end of year	<u>–</u>	<u>126</u>
Analysed into:		
Current portion	<u>–</u>	<u>126</u>

The maturity analysis of lease liabilities is disclosed in note 34 to the Historical Financial Information.

(c) The amounts recognised in profit or loss in relation to leases are as follows:

	Year ended 31 December 2019	Year ended 31 December 2020
	<i>RMB’000</i>	<i>RMB’000</i>
Interest on lease liabilities (note 7)	8	9
Depreciation charge of right-of-use assets	867	493
Expense relating to short-term leases (included in administrative expenses and research and development costs) (note 6)	186	396
Total amount recognised in profit or loss	<u>1,061</u>	<u>898</u>

(d) The total cash outflow for leases and future cash outflows relating to leases that have not yet commenced are disclosed in note 30(c) and note 29, respectively, to the Historical Financial Information.

APPENDIX I

ACCOUNTANTS’ REPORT

15. INTANGIBLE ASSETS

Group

	Software	Intellectual property	Total
	<i>RMB'000</i>	<i>RMB'000</i>	<i>RMB'000</i>
31 December 2019			
At 1 January 2019:			
Cost	138	20,000	20,138
Accumulated amortisation	(48)	(4,450)	(4,498)
Net carrying amount	<u>90</u>	<u>15,550</u>	<u>15,640</u>
Cost at 1 January 2019, net of accumulated amortisation	90	15,550	15,640
Additions	–	1,947	1,947
Amortisation provided during the year (<i>note 6</i>)	(41)	(1,416)	(1,457)
At 31 December 2019, net of accumulated amortisation	<u>49</u>	<u>16,081</u>	<u>16,130</u>
At 31 December 2019:			
Cost	138	21,947	22,085
Accumulated amortisation	(89)	(5,866)	(5,955)
Net carrying amount	<u>49</u>	<u>16,081</u>	<u>16,130</u>
31 December 2020			
At 1 January 2020:			
Cost	138	21,947	22,085
Accumulated amortisation	(89)	(5,866)	(5,955)
Net carrying amount	<u>49</u>	<u>16,081</u>	<u>16,130</u>
Cost at 1 January 2020, net of accumulated amortisation	49	16,081	16,130
Additions	28	–	28
Amortisation provided during the year (<i>note 6</i>)	(44)	(1,660)	(1,704)
At 31 December 2020, net of accumulated amortisation	<u>33</u>	<u>14,421</u>	<u>14,454</u>
At 31 December 2020:			
Cost	166	21,947	22,113
Accumulated amortisation	(133)	(7,526)	(7,659)
Net carrying amount	<u>33</u>	<u>14,421</u>	<u>14,454</u>

APPENDIX I

ACCOUNTANTS’ REPORT

Company

	Software	Intellectual property	Total
	<i>RMB'000</i>	<i>RMB'000</i>	<i>RMB'000</i>
31 December 2019			
At 1 January 2019:			
Cost	138	20,000	20,138
Accumulated amortisation	(48)	(4,450)	(4,498)
Net carrying amount	<u>90</u>	<u>15,550</u>	<u>15,640</u>
Cost at 1 January 2019, net of accumulated amortisation	90	15,550	15,640
Additions	–	1,947	1,947
Amortisation provided during the year	(41)	(1,416)	(1,457)
At 31 December 2019, net of accumulated amortisation	<u>49</u>	<u>16,081</u>	<u>16,130</u>
At 31 December 2019:			
Cost	138	21,947	22,085
Accumulated amortisation	(89)	(5,866)	(5,955)
Net carrying amount	<u>49</u>	<u>16,081</u>	<u>16,130</u>
31 December 2020			
At 1 January 2020:			
Cost	138	21,947	22,085
Accumulated amortisation	(89)	(5,866)	(5,955)
Net carrying amount	<u>49</u>	<u>16,081</u>	<u>16,130</u>
Cost at 1 January 2020, net of accumulated amortisation	49	16,081	16,130
Amortisation provided during the year	(41)	(1,660)	(1,701)
At 31 December 2020, net of accumulated amortisation	<u>8</u>	<u>14,421</u>	<u>14,429</u>
At 31 December 2020:			
Cost	138	21,947	22,085
Accumulated amortisation	(130)	(7,526)	(7,656)
Net carrying amount	<u>8</u>	<u>14,421</u>	<u>14,429</u>

APPENDIX I

ACCOUNTANTS’ REPORT

16. INVENTORIES

Group

	As at 31 December	As at 31 December
	2019	2020
	<i>RMB’000</i>	<i>RMB’000</i>
Raw materials	5,875	10,377
Work in progress	1,060	3,783
Finished goods	1,703	4,263
	<u>8,638</u>	<u>18,423</u>

Company

	As at 31 December	As at 31 December
	2019	2020
	<i>RMB’000</i>	<i>RMB’000</i>
Raw materials	5,875	10,377
Work in progress	1,060	3,783
Finished goods	1,703	4,185
	<u>8,638</u>	<u>18,345</u>

17. TRADE AND BILLS RECEIVABLES

Group and Company

	As at 31 December	As at 31 December
	2019	2020
	<i>RMB’000</i>	<i>RMB’000</i>
Trade receivables	8,496	11,458
Bills receivable	45	244
	<u>8,541</u>	<u>11,702</u>
Impairment	<u>(1,155)</u>	<u>(1,343)</u>
	<u>7,386</u>	<u>10,359</u>

Certain of the Group’s trading terms with its customers are on credit. The credit period is generally within three months, extending up to nine months for certain customers. Each customer has a maximum credit limit. The Group seeks to maintain strict control over its outstanding receivables. Overdue balances are reviewed regularly by senior management. The Group does not hold any collateral or other credit enhancements over its trade receivable balances. Trade receivables are non-interest-bearing.

APPENDIX I

ACCOUNTANTS’ REPORT

An ageing analysis of the trade receivables of the Group and the Company as at the end of each of the Relevant Periods (based on the invoice date and net of loss allowance) is as follows:

	As at 31 December	As at 31 December
	2019	2020
	<i>RMB'000</i>	<i>RMB'000</i>
Within 1 year	6,257	9,304
1 to 2 years	892	536
2 to 3 years	176	229
Over 3 years	16	46
	<u>7,341</u>	<u>10,115</u>

The movements in the loss allowance for impairment of trade receivables are as follows:

	As at 31 December	As at 31 December
	2019	2020
	<i>RMB'000</i>	<i>RMB'000</i>
At beginning of year	732	1,155
Impairment losses, net (<i>note 6</i>)	423	188
At end of year	<u>1,155</u>	<u>1,343</u>

An impairment analysis is performed at the end of each of the Relevant Periods using a provision matrix to measure expected credit losses. The provision rates are based on ageing for groupings of various customer segments with similar loss patterns. The calculation reflects the probability-weighted outcome, the time value of money and reasonable and supportable information that is available at the end of each of the Relevant Periods about past events, current conditions and forecasts of future economic conditions.

Set out below is the information about the credit risk exposure on the Group’s and the Company’s trade receivables using a provision matrix:

As at 31 December 2019

	Gross carrying amount	Expected credit loss rate	Expected credit loss
	<i>RMB'000</i>	<i>%</i>	<i>RMB'000</i>
Less than 1 year	6,645	5.84%	388
1 to 2 years	1,151	22.50%	259
2 to 3 years	404	56.44%	228
Over 3 years	296	94.59%	280
	<u>8,496</u>	13.59%	<u>1,155</u>

APPENDIX I

ACCOUNTANTS’ REPORT

As at 31 December 2020

	Gross carrying amount	Expected credit loss rate	Expected credit loss
	<i>RMB'000</i>	<i>%</i>	<i>RMB'000</i>
Less than 1 year	9,778	4.85%	474
1 to 2 years	681	21.29%	145
2 to 3 years	485	52.78%	256
Over 3 years	514	91.05%	468
	<u>11,458</u>	11.72%	<u>1,343</u>

18. PREPAYMENTS, OTHER RECEIVABLES AND OTHER ASSETS

Group

	As at 31 December 2019	As at 31 December 2020
	<i>RMB'000</i>	<i>RMB'000</i>
Current		
Prepayments	2,761	3,143
Value-added tax recoverable	829	803
Other receivables	1,390	556
	<u>4,980</u>	<u>4,502</u>
Non-current		
Advance payments for property, plant and equipment	2,599	1,617
	<u>7,579</u>	<u>6,119</u>

Company

	As at 31 December 2019	As at 31 December 2020
	<i>RMB'000</i>	<i>RMB'000</i>
Current		
Prepayments	2,696	2,862
Value-added tax recoverable	829	781
Other receivables	1,375	384
	<u>4,900</u>	<u>4,027</u>
Non-current		
Advance payments for property, plant and equipment	2,599	1,617
	<u>7,499</u>	<u>5,644</u>

APPENDIX I

ACCOUNTANTS’ REPORT

Included in the Group’s and the Company’s prepayments, other receivables and other assets were amounts due from the Group’s and the Company’s related parties of RMB123,000 and nil as at 31 December 2019 and 2020, respectively.

The financial assets included in the above balances relate to receivables for which there was no recent history of default and past due amounts. As at the end of each of the Relevant Periods, the loss allowance was assessed to be minimal.

19. DUE FROM A DIRECTOR

Group and Company

Amounts due from a director, disclosed pursuant to section 383(1)(d) of the Hong Kong Companies Ordinance and Part 3 of the Companies (Disclosure of Information about Benefits of Directors) Regulation, are as follows:

Name	At 31 December 2020 <i>RMB’000</i>	Maximum amount outstanding during the year <i>RMB’000</i>	At 31 December 2019 and 1 January 2020 <i>RMB’000</i>	Maximum amount outstanding during the year <i>RMB’000</i>	At 1 January 2019 <i>RMB’000</i>	Security held
Dr. Zheng Pan*	–	10,000	9,622	10,000	–	None
Shukang biomedical (Hangzhou) Co., Ltd** (“Shukang biomedical”)	–	500	–	–	–	None
Total	–		9,622		–	

* The loans granted to Dr. Zheng Pan for the years ended 31 December 2019 and 2020 were unsecured, bore interest at interest rates of 3.83% and 4.03% per annum, respectively, and were repayable within one year and six months, respectively.

** The loan granted to Shukang biomedical, an entity controlled by Dr. Zheng Pan, for the year ended 31 December 2020, was unsecured, interest-free and repayable on demand.

20. FINANCIAL ASSETS AT FAIR VALUE THROUGH PROFIT OR LOSS

Group and Company

	As at 31 December 2019 <i>RMB’000</i>	As at 31 December 2020 <i>RMB’000</i>
Unlisted investments, at fair value	123,495	105,192

The unlisted investments represented wealth management products, unit trust and structured deposits issued by commercial banks and financial institutions in Mainland China. They were mandatorily classified as financial assets at fair value through profit or loss as their contractual cash flows are not solely payments of principal and interest. For information about the methods and assumptions used in determining fair value, please refer to note 33 to the Historical Financial Information.

APPENDIX I

ACCOUNTANTS’ REPORT

21. CASH AND CASH EQUIVALENTS

Group

	As at 31 December 2019	As at 31 December 2020
	<i>RMB’000</i>	<i>RMB’000</i>
Cash and bank balances	22,453	118,207
Time deposits	18,975	431,593
Cash and cash equivalents	<u>41,428</u>	<u>549,800</u>
Denominated in:		
RMB	19,855	472,244
United States dollar (“US\$”)	21,573	77,556
Total cash and cash equivalents	<u>41,428</u>	<u>549,800</u>

Company

	As at 31 December 2019	As at 31 December 2020
	<i>RMB’000</i>	<i>RMB’000</i>
Cash and bank balances	22,223	117,785
Time deposits	18,975	431,593
Cash and cash equivalents	<u>41,198</u>	<u>549,378</u>
Denominated in:		
RMB	19,625	471,822
US\$	21,573	77,556
Total cash and cash equivalents	<u>41,198</u>	<u>549,378</u>

The RMB is not freely convertible into other currencies, however, under Mainland China’s Foreign Exchange Control Regulations and Administration of Settlement, Sale and Payment of Foreign Exchange Regulations, the Group is permitted to exchange RMB for other currencies through banks authorised to conduct foreign exchange business.

Cash at banks earns interest at floating rates based on daily bank deposit rates. Short term time deposits are made for varying periods of between 3 months and 1 year depending on the immediate cash requirements of the Group, and earn interest at the respective short term time deposit rates. The bank balances and time deposits are deposited with creditworthy banks with no recent history of default.

APPENDIX I

ACCOUNTANTS’ REPORT

22. TRADE PAYABLES

Group

	As at 31 December	As at 31 December
	2019	2020
	<i>RMB'000</i>	<i>RMB'000</i>
Trade payables	5,248	7,599

An ageing analysis of the trade payables as at the end of each of the Relevant Periods, based on the invoice date, is as follows:

	As at 31 December	As at 31 December
	2019	2020
	<i>RMB'000</i>	<i>RMB'000</i>
Within 1 year	5,238	7,482
1 to 2 years	2	110
2 to 3 years	8	–
Over 3 years	–	7
	<u>5,248</u>	<u>7,599</u>

Company

	As at 31 December	As at 31 December
	2019	2020
	<i>RMB'000</i>	<i>RMB'000</i>
Trade payables	5,248	7,578

An ageing analysis of the trade payables as at the end of each of the Relevant Periods, based on the invoice date, is as follows:

	As at 31 December	As at 31 December
	2019	2020
	<i>RMB'000</i>	<i>RMB'000</i>
Within 1 year	5,238	7,461
1 to 2 years	2	110
2 to 3 years	8	–
Over 3 years	–	7
	<u>5,248</u>	<u>7,578</u>

Included in the Group’s and the Company’s trade payables were amounts due to related parties of RMB249,000 and nil as at 31 December 2019 and 2020, respectively.

Trade payables are non-interest-bearing and are normally settled on 30-day terms.

APPENDIX I

ACCOUNTANTS’ REPORT

23. OTHER PAYABLES AND ACCRUALS

Group

	As at 31 December	As at 31 December
	2019	2020
	<i>RMB’000</i>	<i>RMB’000</i>
Other payables	10,158	8,946
Government grants	8,000	8,000
Accrued payroll	7,210	9,362
Accrued expenses	202	277
Refund liabilities	896	2,208
Taxes payable other than corporate income tax	847	2,481
Deferred revenue	98	40
	<u>27,411</u>	<u>31,314</u>

Other payables are non-interest-bearing and repayable on demand.

Company

	As at 31 December	As at 31 December
	2019	2020
	<i>RMB’000</i>	<i>RMB’000</i>
Other payables	10,158	8,915
Government grants	8,000	8,000
Accrued payroll	7,210	9,187
Accrued expenses	202	277
Refund liabilities	896	2,208
Taxes payable other than corporate income tax	847	2,476
Deferred revenue	98	40
	<u>27,411</u>	<u>31,103</u>

Other payables are non-interest-bearing and repayable on demand.

APPENDIX I

ACCOUNTANTS’ REPORT

24. INTEREST-BEARING BANK BORROWING

Group and Company

	Effective interest rate (%)	Maturity	As at 31 December 2019 RMB’000	As at 31 December 2020 RMB’000
Current				
Bank loan – secured	3.92	2020	10,012	–
Analysed into:				
Within one year or on demand			10,012	–

A director of the Group, Dr. Zheng Pan, has guaranteed the Group’s bank loans up to RMB10,000,000 and RMB10,000,000 during the years ended 31 December 2019 and 2020, respectively.

25. CONTRACT LIABILITIES

Group and Company

The Group recognised the following revenue-related contract liabilities:

	As at 31 December 2019 RMB’000	As at 31 December 2020 RMB’000
Current	5,282	9,718

During the Relevant Periods, contract liabilities represented the obligations to transfer goods to customers for which the Group has received consideration.

26. SHARE CAPITAL/PAID-IN CAPITAL

Shares

	As at 31 December 2019 RMB’000	As at 31 December 2020 RMB’000
Issued and fully paid:		
Ordinary shares	–	360,000

APPENDIX I

ACCOUNTANTS’ REPORT

A summary of movements in the Company’s share capital is as follows:

	<u>Number of shares</u>	<u>Share capital</u>
		<i>RMB’000</i>
Issued and fully paid as at 1 January 2019, 31 December 2019 and 1 January 2020	–	–
Issue of ordinary shares upon conversion into a joint stock company (a)	83,022,715	83,023
Issue of ordinary shares (b)	12,173,090	12,173
Transfer from reserves to share capital (c)	264,804,195	264,804
	<u>360,000,000</u>	<u>360,000</u>
As at 31 December 2020	<u>360,000,000</u>	<u>360,000</u>

Paid-in capital

	<u>Total</u>
	<i>RMB’000</i>
As at 1 January 2019	69,683
Capital contribution by shareholders	4,719
	<u>74,402</u>
As at 31 December 2019 and 1 January 2020	74,402
Capital contribution by shareholders (d)	8,621
Conversion into a joint stock company (a)	(83,023)
	<u>–</u>
As at 31 December 2020	<u>–</u>

Notes:

- (a) In October 2020, the Company converted into a joint stock company with limited liability under the Company Law of the PRC. The net assets of the Company as of the conversion base date, including paid-in capital, other reserves and accumulated losses, amounting to RMB227,659,000 were converted into 83,022,715 ordinary shares of RMB1.00 each. The excess of the net assets converted over the nominal value of the ordinary shares was credited to the Company’s other reserves.
- (b) In November 2020, the Company issued 12,173,090 shares in total with par value of RMB1.00 each to Zhangjiagang Taikang Qianzhen Equity Investment Partnership (Limited Partnership), Shenzhen Tencent Information Technology Co., Ltd., Zhuhai Yitai Management Consulting Enterprise (Limited Partnership), Suzhou Chenzhide Investment Partnership (Limited Partnership), Nanjing Jianye Sanzheng Shunxin Equity Investment Partnership (Limited Partnership), CICC Pucheng Investment Co., Ltd., Shanghai Guangkong Guanghai Equity Investment Center (Limited Partnership), Suzhou Likang Equity Investment Center (Limited Partnership), Shanghai Guofang Zouzhen Enterprise Service Center (Limited Partnership), QM153 Limited and Mr. Teng Rongsong. Proceeds of RMB513,180,000 were received during the year ended 31 December 2020.
- (c) In December 2020, RMB264,804,195 of the share premium was converted into 264,804,195 ordinary shares of RMB1.00 each.
- (d) In September 2020, the Company received capital contribution of RMB8,621,000 from Hangzhou Yantai Investment Partnership (Limited Partnership) (“Hangzhou Yantai”) and Hangzhou Hengtai Investment Partnership (Limited Partnership) (“Hangzhou Hengtai”), pursuant to capital increase agreements in December 2017 and 2019, respectively.

APPENDIX I

ACCOUNTANTS’ REPORT

27. RESERVES

Group

The amounts of the Group’s reserves and the movements therein for the Relevant Periods are presented in the consolidated statements of changes in equity.

Share premium

The share premium of the Group represents the share premium contributed by the shareholders of the Company after its conversion into a joint stock company in November 2020.

Share award reserve

The Group’s share award reserve represents the share-based compensation reserve due to equity-settled share award, details of the movements are set out in the consolidated statements of changes in equity.

Other reserves

Other reserves of the Group mainly represent the share premium contributed by the shareholders of the Company before its conversion into a joint stock company in November 2020.

Company

	Share premium	Other reserves	Share award reserve	Retained profits/ (accumulated losses)	Total
	<i>RMB’000</i>	<i>RMB’000</i>	<i>RMB’000</i>	<i>RMB’000</i>	<i>RMB’000</i>
At 1 January 2019	–	167,920	23,090	(114,753)	76,257
Total comprehensive loss for the year	–	–	–	(78,614)	(78,614)
Equity-settled share award expense	–	–	57,564	–	57,564
Capital contribution by shareholders	–	87,181	–	–	87,181
At 31 December 2019 and 1 January 2020	–	255,101	80,654	(193,367)	142,388
Total comprehensive loss for the year	–	–	–	(119,848)	(119,848)
Equity-settled share award expense	–	–	111,176	–	111,176
Capital contribution by shareholders	501,007	–	–	–	501,007
Conversion into a joint stock company	–	(383,321)	–	383,321	–
Transfer to share capital	(264,804)	–	–	–	(264,804)
At 31 December 2020	<u>236,203</u>	<u>(128,220)</u>	<u>191,830</u>	<u>70,106</u>	<u>369,919</u>

APPENDIX I

ACCOUNTANTS’ REPORT

28. SHARE-BASED PAYMENTS

The Company adopted employee incentive schemes (the “Schemes”) for the purpose of providing incentives and rewards to eligible participants who contribute to the success of the Company’s operations. Eligible participants of the Schemes include the Company’s directors, senior management and other employees. During the Relevant Periods, the Group granted ordinary shares of the Company under the Schemes through Hangzhou Hengtai and Hangzhou Yantai to certain employees.

In January 2018, 562,834 restricted ordinary shares of Hangzhou Yantai were granted to ten selected employees for a total consideration of RMB563,000.

In December 2019, 4,151,136 registered ordinary shares of Hangzhou Hengtai were granted to two selected employees for a total consideration of RMB4,151,000.

In September 2020 and December 2020, a total of 4,469,665 registered ordinary shares of Hangzhou Yantai were granted to thirty selected employees for a total consideration of RMB4,470,000.

For share grants to the employees in January 2018 and one employee in December 2019, there are service periods requirement for which this requirement was terminated in September 2020. Except for the above, there are no service periods or performance target requirements for other share grants. The fair value of services received in return for shares granted was measured by reference to the fair value of shares granted and the subscription price paid by employees.

The discounted cash flow method and back-solve method were used to determine the underlying equity fair value of the Company and the OPM model to determine the fair value of the shares granted. The key inputs into the model other than the underlying equity fair value of the Company at the date of grant were as follows:

	As at 31 December 2019	As at 31 December 2020
Risk-free interest rate (%)	2.7	2.8-2.9
Volatility (%)	38.6	47.3-47.9

During the Relevant Periods, share award expenses of RMB57,564,000 and RMB111,176,000, respectively, were charged to profit or loss, which included expenses for one and four directors, of RMB56,932,000 and RMB65,525,000, respectively.

29. COMMITMENTS

The Group had a lease contract entered into as a lessee that has not yet commenced as at 31 December 2019. The future lease payments for these non-cancellable lease contracts are falling due as follows:

	As at 31 December 2019	As at 31 December 2020
	<i>RMB’000</i>	<i>RMB’000</i>
Within one year	166	–
In the second to fifth years, inclusive	166	–
	332	–

APPENDIX I

ACCOUNTANTS’ REPORT

30. NOTES TO THE CONSOLIDATED STATEMENTS OF CASH FLOWS

(a) Major non-cash transactions

The Group had non-cash additions to right-of-use assets of nil and RMB331,000 and non-cash additions to lease liabilities of nil and RMB331,000 for the years ended 31 December 2019 and 2020, respectively, in respect of lease arrangements for office premises.

(b) Changes in liabilities arising from financing activities

	Interest-bearing bank borrowing	Lease liabilities
	<i>RMB’000</i>	<i>RMB’000</i>
At 1 January 2019	–	725
Changes from financing cash flows	9,709	(733)
Interest expense	303	8
	<hr/>	<hr/>
At 31 December 2019 and 1 January 2020	10,012	–
Changes from financing cash flows	(10,311)	(214)
Interest expense	299	9
New leases	–	331
	<hr/>	<hr/>
At 31 December 2020	<hr/> <hr/>	<hr/> <hr/>

(c) Total cash outflow for leases

The total cash outflow for leases included in the statements of cash flows is as follows:

	Year ended 31 December	Year ended 31 December
	2019	2020
	<i>RMB’000</i>	<i>RMB’000</i>
Within operating activities	186	396
Within financing activities	733	214
	<hr/>	<hr/>
	919	610
	<hr/> <hr/>	<hr/> <hr/>

31. RELATED PARTY TRANSACTIONS

Name	Relationship
Dr. Zheng Pan	Director
Shukang biomedical	An entity controlled by a director
Jinhua City Wucheng District Jingxin Trading Corporation (“Jingxin Trading”)	An entity controlled by a relative of a director
Jinhua City Wucheng District Qirui Trading Corporation (“Qirui Trading”)	An entity controlled by a relative of a director
Jinhua City Wucheng District Jingqi Trading Corporation (“Jingqi Trading”) *	An entity controlled by a relative of a director

* Jingqi Trading was liquidated on 25 September 2019.

APPENDIX I

ACCOUNTANTS’ REPORT

- (a) In addition to the transactions detailed elsewhere in the Historical Financial Information, the Group had the following transactions with related parties during the Relevant Periods:

	<i>Notes</i>	Year ended 31 December 2019	Year ended 31 December 2020
		<i>RMB’000</i>	<i>RMB’000</i>
Loans to:			
Dr. Zheng Pan	<i>(i)</i>	10,000	10,000
Shukang biomedical	<i>(ii)</i>	–	500
		<u>10,000</u>	<u>10,500</u>
Repayment of loans to:			
Dr. Zheng Pan		–	20,000
Shukang biomedical		–	500
		<u>–</u>	<u>20,500</u>
Interest from:			
Dr. Zheng Pan	<i>(i)</i>	303	299
Payment on behalf of the Group by:			
Dr. Zheng Pan		41	–
Repayment of payment on behalf of the Group by:			
Dr. Zheng Pan		–	389
Purchases of goods from:			
Jingxin Trading	<i>(iii)</i>	–	1,182
Qirui Trading	<i>(iii)</i>	–	593
Jingqi Trading	<i>(iii)</i>	1,096	–
		<u>1,096</u>	<u>1,775</u>

Notes:

- (i) The loans granted to Dr. Zheng Pan for the years ended 31 December 2019 and 2020 are unsecured, bear interest at interest rates of 3.83% and 4.03% per annum, respectively, and repayable within one year and six months, respectively.
- (ii) The loan granted to Shukang biomedical is unsecured, non-interest-bearing and repayable on demand.
- (iii) The purchases of goods from the related parties were made according to the published prices and conditions offered by the related parties to their major customers.

- (b) Other transactions with related parties:

A director of the Group, Dr. Zheng Pan, has guaranteed the Group’s bank loans up to RMB10,000,000 and RMB10,000,000 during the years ended 31 December 2019 and 2020, respectively.

APPENDIX I

ACCOUNTANTS’ REPORT

(c) Outstanding balances with related parties:

		As at 31 December 2019	As at 31 December 2020
	<i>Notes</i>	<i>RMB’000</i>	<i>RMB’000</i>
Due from a director*			
Dr. Zheng Pan	(i)	9,622	–
Prepayments**			
Jingxin Trading	(ii)	123	–
Trade payables**			
Jingqi Trading	(iii)	249	–

* The balance is non-trade in nature.

** The balances are trade in nature.

Notes:

- (i) The outstanding balance is unsecured, bear interest at an interest rate of 3.83% per annum and repayable within one year.
- (ii) The balance is unsecured and interest-free.
- (iii) The balance is unsecured, interest-free and repayable on demand.

(d) Compensation of key management personnel of the Group:

	Year ended 31 December 2019	Year ended 31 December 2020
	<i>RMB’000</i>	<i>RMB’000</i>
Salaries, bonuses, allowances and benefit in kind	3,763	5,227
Pension scheme contributions	45	7
Equity-settled share award expense	57,044	78,343
Total compensation paid to key management personnel	60,852	83,577

Further details of directors’ remuneration are included in note 8 to the Historical Financial Information.

APPENDIX I

ACCOUNTANTS’ REPORT

32. FINANCIAL INSTRUMENTS BY CATEGORY

The carrying amounts of each of the categories of financial instruments as at the end of each of the Relevant Periods are as follows:

Group

Financial assets

As at 31 December 2019

	Financial assets at fair value through profit or loss	Financial assets at amortised cost	Total
	<i>RMB’000</i>	<i>RMB’000</i>	<i>RMB’000</i>
Trade and bills receivables	–	7,386	7,386
Financial assets included in prepayments, other receivables and other assets	–	1,390	1,390
Due from a director	–	9,622	9,622
Financial assets at fair value through profit or loss	123,495	–	123,495
Cash and cash equivalents	–	41,428	41,428
	<u>123,495</u>	<u>59,826</u>	<u>183,321</u>

As at 31 December 2020

	Financial assets at fair value through profit or loss	Financial assets at amortised cost	Total
	<i>RMB’000</i>	<i>RMB’000</i>	<i>RMB’000</i>
Trade and bills receivables	–	10,359	10,359
Financial assets included in prepayments, other receivables and other assets	–	556	556
Financial assets at fair value through profit or loss	105,192	–	105,192
Cash and cash equivalents	–	549,800	549,800
	<u>105,192</u>	<u>560,715</u>	<u>665,907</u>

APPENDIX I

ACCOUNTANTS’ REPORT

Financial liabilities

As at 31 December 2019

	Financial liabilities at amortised cost
	<i>RMB’000</i>
Trade payables	5,248
Financial liabilities included in other payables and accruals	10,158
Interest-bearing bank borrowing	10,012
	<u>25,418</u>

As at 31 December 2020

	Financial liabilities at amortised cost
	<i>RMB’000</i>
Trade payables	7,599
Financial liabilities included in other payables and accruals	8,946
Lease liabilities	126
	<u>16,671</u>

Company

Financial assets

As at 31 December 2019

	Financial assets at fair value through profit or loss	Financial assets at amortised cost	Total
	<i>RMB’000</i>	<i>RMB’000</i>	<i>RMB’000</i>
Trade and bills receivables	–	7,386	7,386
Financial assets included in prepayments, other receivables and other assets	–	1,375	1,375
Due from a director	–	9,622	9,622
Financial assets at fair value through profit or loss	123,495	–	123,495
Cash and cash equivalents	–	41,198	41,198
	<u>123,495</u>	<u>59,581</u>	<u>183,076</u>

APPENDIX I

ACCOUNTANTS’ REPORT

As at 31 December 2020

	Financial assets at fair value through profit or loss	Financial assets at amortised cost	Total
	<i>RMB’000</i>	<i>RMB’000</i>	<i>RMB’000</i>
Trade and bills receivables	–	10,359	10,359
Financial assets included in prepayments, other receivables and other assets	–	384	384
Financial assets at fair value through profit or loss	105,192	–	105,192
Cash and cash equivalents	–	549,378	549,378
	<u>105,192</u>	<u>560,121</u>	<u>665,313</u>

Financial liabilities

As at 31 December 2019

	Financial liabilities at amortised cost
	<i>RMB’000</i>
Trade payables	5,248
Financial liabilities included in other payables and accruals	10,158
Interest-bearing bank borrowing	10,012
	<u>25,418</u>

As at 31 December 2020

	Financial liabilities at amortised cost
	<i>RMB’000</i>
Trade payables	7,578
Financial liabilities included in other payables and accruals	8,915
Lease liabilities	126
	<u>16,619</u>

33. FAIR VALUE AND FAIR VALUE HIERARCHY OF FINANCIAL INSTRUMENTS

Management has assessed that the fair values of cash and cash equivalents, financial assets included in prepayments, other receivables and other assets, an amount due from a director, trade receivables, trade payables, interest-bearing bank borrowing, financial liabilities included in other payables and accruals and lease liabilities approximate to their carrying amounts largely due to the short-term maturities of these instruments. All the carrying amounts of the Group’s financial liabilities approximate to their fair value.

APPENDIX I

ACCOUNTANTS’ REPORT

The Group’s finance department headed by the chief financial officer is responsible for determining the policies and procedures for the fair value measurement of financial instruments. The finance department reports directly to the chief financial officer. At the end of each of the Relevant Periods, the finance department analyses the movements in the values of financial instruments and determines the major inputs applied in the valuation. The valuation is reviewed and approved by the chief financial officer. The valuation process and results are discussed with the directors of the Company periodically for financial reporting.

The fair values of the financial assets and liabilities are included at the amount at which the instrument could be exchanged in a current transaction between willing parties, other than in a forced or liquidation sale. The following methods and assumptions were used to estimate the fair values.

Fair value hierarchy

The following tables illustrate the fair value measurement hierarchy of the Group’s financial instruments:

Group and Company

Assets measured at fair value:

As at 31 December 2019

	Fair value measurement using			Total
	Quoted prices in active markets	Significant observable inputs	Significant unobservable inputs	
	(Level 1)	(Level 2)	(Level 3)	
	<i>RMB’000</i>	<i>RMB’000</i>	<i>RMB’000</i>	
Financial assets at fair value through profit or loss	–	123,495	–	123,495

As at 31 December 2020

	Fair value measurement using			Total
	Quoted prices in active markets	Significant observable inputs	Significant unobservable inputs	
	(Level 1)	(Level 2)	(Level 3)	
	<i>RMB’000</i>	<i>RMB’000</i>	<i>RMB’000</i>	
Financial assets at fair value through profit or loss	–	105,192	–	105,192

The Group and the Company did not have any financial liabilities measured at fair value as at 31 December 2019 and 2020.

During the Relevant Periods, there were no transfers of fair value measurements between Level 1 and Level 2 and no transfers into or out of Level 3 for both financial assets and financial liabilities.

APPENDIX I

ACCOUNTANTS’ REPORT

34. FINANCIAL RISK MANAGEMENT OBJECTIVES AND POLICIES

The Group’s principal financial instruments comprise interest-bearing bank borrowing and cash and cash equivalents. The main purpose of these financial instruments is to raise finance for the Group’s operations. The Group has various other financial assets and liabilities such as trade and other receivables and trade and other payables, which arise directly from its operations.

The main risks arising from the Group’s financial instruments are foreign currency risk, credit risk and liquidity risk. The board of directors reviews and agrees policies for managing each of these risks and they are summarised below.

Foreign currency risk

Foreign currency risk is the risk of loss resulting from changes in foreign currency exchange rates. Fluctuations in exchange rates between RMB and other currencies in which the Group conducts business may affect the Group’s financial condition and results of operations. The Group seeks to limit its exposure to foreign currency risk by minimising its net foreign currency position.

The following table demonstrates the sensitivity as at the end of each of the Relevant Periods to a reasonably possible change in foreign currency exchange rates, with all other variables held constant, of the Group’s loss before tax (due to translation of monetary assets and liabilities) and the Group’s equity.

	<u>Increase/ (decrease) in rate of foreign currency</u>	<u>(Increase)/ decrease in loss before tax</u>	<u>Increase/ (decrease) in equity</u>
	<i>%</i>	<i>RMB’000</i>	<i>RMB’000</i>
31 December 2019			
If the RMB weakens against the US\$	5	1,159	1,159
If the RMB strengthens against the US\$	(5)	(1,159)	(1,159)
31 December 2020			
If the RMB weakens against the US\$	5	3,828	3,828
If the RMB strengthens against the US\$	(5)	(3,828)	(3,828)

Credit risk

The Group is exposed to credit risk in relation to its cash and cash equivalents, an amount due from a director, trade receivables and financial assets included in prepayments, other receivables and other assets. The carrying amounts of each class of the above financial assets represent the Group’s maximum exposure to credit risk in relation to financial assets.

Maximum exposure and year-end staging

The tables below show the credit quality and the maximum exposure to credit risk based on the Group’s credit policy, which is mainly based on ageing information unless other information is available without undue cost or effort, and year-end staging classification. The amounts presented are gross carrying amounts for financial assets.

APPENDIX I

ACCOUNTANTS’ REPORT

Group

As at 31 December 2019

	12-month	Lifetime ECLs			Total
	ECLs				
	Stage 1	Stage 2	Stage 3	Simplified approach	
	RMB'000	RMB'000	RMB'000	RMB'000	RMB'000
Trade receivables*	–	–	–	8,496	8,496
Bills receivable**	45	–	–	–	45
Financial assets included in prepayments, other receivables and other assets					
– Normal**	1,390	–	–	–	1,390
Due from a director					
– Normal**	9,622	–	–	–	9,622
Cash and cash equivalents					
– Not yet past due	41,428	–	–	–	41,428
	<u>52,485</u>	<u>–</u>	<u>–</u>	<u>8,496</u>	<u>60,981</u>

As at 31 December 2020

	12-month	Lifetime ECLs			Total
	ECLs				
	Stage 1	Stage 2	Stage 3	Simplified approach	
	RMB'000	RMB'000	RMB'000	RMB'000	RMB'000
Trade receivables*	–	–	–	11,458	11,458
Bills receivable**	244	–	–	–	244
Financial assets included in prepayments, other receivables and other assets					
– Normal**	556	–	–	–	556
Cash and cash equivalents					
– Not yet past due	549,800	–	–	–	549,800
	<u>550,600</u>	<u>–</u>	<u>–</u>	<u>11,458</u>	<u>562,058</u>

APPENDIX I

ACCOUNTANTS’ REPORT

Company

As at 31 December 2019

	12-month	Lifetime ECLs			Total
	ECLs	Stage 2	Stage 3	Simplified approach	
	Stage 1				
	RMB'000	RMB'000	RMB'000	RMB'000	RMB'000
Trade receivables*	–	–	–	8,496	8,496
Bills receivable**	45	–	–	–	45
Financial assets included in prepayments, other receivables and other assets					
– Normal**	1,375	–	–	–	1,375
Due from a director					
– Normal**	9,622	–	–	–	9,622
Cash and cash equivalents					
– Not yet past due	41,198	–	–	–	41,198
	<u>52,240</u>	<u>–</u>	<u>–</u>	<u>8,496</u>	<u>60,736</u>

As at 31 December 2020

	12-month	Lifetime ECLs			Total
	ECLs	Stage 2	Stage 3	Simplified approach	
	Stage 1				
	RMB'000	RMB'000	RMB'000	RMB'000	RMB'000
Trade receivables*	–	–	–	11,458	11,458
Bills receivable**	244	–	–	–	244
Financial assets included in prepayments, other receivables and other assets					
– Normal**	384	–	–	–	384
Cash and cash equivalents					
– Not yet past due	549,378	–	–	–	549,378
	<u>550,006</u>	<u>–</u>	<u>–</u>	<u>11,458</u>	<u>561,464</u>

* For trade receivables to which the Group applies the simplified approach for impairment, information based on the provision matrix is disclosed in note 17 to the Historical Financial Information.

** The credit quality of the bills receivable, financial assets included in prepayments, other receivables and other assets and an amount due from a director is considered to be “normal” when they are not past due and there is no information indicating that the financial assets had a significant increase in credit risk since initial recognition. Otherwise, the credit quality of the financial assets is considered to be “doubtful”.

Further quantitative data in respect of the Group’s exposure to credit risk arising from trade receivables are disclosed in note 17 to the Historical Financial Information.

APPENDIX I

ACCOUNTANTS’ REPORT

Liquidity risk

In the management of the liquidity risk, the Group monitors and maintains a level of cash and cash equivalents deemed adequate by the management of the Group to finance the operations and mitigate the effects of fluctuations in cash flows.

The maturity profile of the Group’s financial liabilities as at the end of each of the Relevant Periods, based on the contractual undiscounted payments, is as follows:

Group

As at 31 December 2019

	On demand	Less than 3 months	3 to 12 months	1 to 5 years	Total
	<i>RMB’000</i>	<i>RMB’000</i>	<i>RMB’000</i>	<i>RMB’000</i>	<i>RMB’000</i>
Trade payables	5,248	–	–	–	5,248
Financial liabilities included in other payables and accruals	10,158	–	–	–	10,158
Interest-bearing bank borrowing	–	10,094	–	–	10,094
	<u>15,406</u>	<u>10,094</u>	<u>–</u>	<u>–</u>	<u>25,500</u>

As at 31 December 2020

	On demand	Less than 3 months	3 to 12 months	1 to 5 years	Total
	<i>RMB’000</i>	<i>RMB’000</i>	<i>RMB’000</i>	<i>RMB’000</i>	<i>RMB’000</i>
Trade payables	7,599	–	–	–	7,599
Financial liabilities included in other payables and accruals	8,946	–	–	–	8,946
Lease liabilities	–	43	86	–	129
	<u>16,545</u>	<u>43</u>	<u>86</u>	<u>–</u>	<u>16,674</u>

Company

As at 31 December 2019

	On demand	Less than 3 months	3 to 12 months	1 to 5 years	Total
	<i>RMB’000</i>	<i>RMB’000</i>	<i>RMB’000</i>	<i>RMB’000</i>	<i>RMB’000</i>
Trade payables	5,248	–	–	–	5,248
Financial liabilities included in other payables and accruals	10,158	–	–	–	10,158
Interest-bearing bank borrowing	–	10,094	–	–	10,094
	<u>15,406</u>	<u>10,094</u>	<u>–</u>	<u>–</u>	<u>25,500</u>

APPENDIX I

ACCOUNTANTS’ REPORT

As at 31 December 2020

	<u>On demand</u>	<u>Less than 3 months</u>	<u>3 to 12 months</u>	<u>1 to 5 years</u>	<u>Total</u>
	<i>RMB'000</i>	<i>RMB'000</i>	<i>RMB'000</i>	<i>RMB'000</i>	<i>RMB'000</i>
Trade payables	7,578	–	–	–	7,578
Financial liabilities included in other payables and accruals	8,915	–	–	–	8,915
Lease liabilities	–	43	86	–	129
	<u>16,493</u>	<u>43</u>	<u>86</u>	<u>–</u>	<u>16,622</u>

Capital management

The primary objectives of the Group’s capital management are to safeguard the Group’s ability to continue as a going concern and to maintain healthy capital ratios in order to support its business and maximise shareholders’ value.

The Group monitors capital by regularly reviewing the capital structure. As a part of this review, the Group considers the cost of capital and the risks associated with the issued share capital. The Group may adjust the dividend payment to shareholders, return capital to shareholders, issue new shares or repurchase the Company’s shares.

35. EVENTS AFTER THE RELEVANT PERIODS

There were no other significant events that required additional disclosure or adjustments occurred after the end of the Relevant Periods.

36. SUBSEQUENT FINANCIAL STATEMENTS

No audited financial statements have been prepared by the Company, the Group or any of its subsidiary in respect of any period subsequent to 31 December 2020.

[REDACTED]

APPENDIX II

[REDACTED]

[REDACTED]

APPENDIX II

[REDACTED]

[REDACTED]

[REDACTED]

[REDACTED]

APPENDIX III

TAXATION AND FOREIGN EXCHANGE

TAXATION IN THE PRC

Taxes on Dividend

Individual Investors

According to the Individual Income Tax Law of the People's Republic of China (《中華人民共和國個人所得稅法》), as implemented on September 10, 1980 and recently amended on August 31, 2018, and the Implementation Regulations of the Individual Income Tax Law of the People's Republic of China (《中華人民共和國個人所得稅法實施條例》), as implemented on January 28, 1994 and recently amended on December 18, 2018 by the State Council, dividends distributed by PRC enterprises are subject to individual income tax levied at a flat rate of 20%. For a foreign individual who is not a resident of the PRC, the receipt of dividends from an enterprise in the PRC is normally subject to individual income tax of 20% unless specifically exempted by the tax authority of the State Council or reduced by relevant tax treaty.

Pursuant to the Arrangement between the Mainland China and the Hong Kong Special Administrative Region for the Avoidance of Double Taxation and the Prevention of Fiscal Evasion with respect to Taxes on Income (《內地和香港特別行政區關於對所得避免雙重徵稅和防止偷漏稅的安排》), which was signed on August 21, 2006 between the Mainland China and the Hong Kong with respect to taxes on income, the PRC government may impose tax on the dividends paid by a PRC company to Hong Kong residents (including natural persons and legal entities) subject to a maximum of 10% of the gross amount of dividends payable, or 5% for Hong Kong residents directly holding 25% or more of equity interest in such PRC company.

Enterprise Investors

In accordance with the Enterprise Income Tax Law of the People's Republic of China (《中華人民共和國企業所得稅法》), as promulgated on March 16, 2007 and recently amended on December 29, 2018, and the Implementation Regulations of the Enterprise Income Tax Law of the People's Republic of China (《中華人民共和國企業所得稅法實施條例》), which was promulgated on December 6, 2007 and amended on April 23, 2019, a non-PRC resident enterprise is generally subject to a 10% enterprise income tax on PRC-sourced income, including dividends received from a PRC resident enterprise whose shares are issued and listed in Hong Kong, if such non-PRC resident enterprise has no office or premises established in China or the income derived or accrued has no de facto relationship with the office or premises established. The aforesaid income tax payable by non-PRC resident enterprises shall be withheld at source, with the payer of the income being the withholding agent. When making such payment or when such payment becomes due and payable, the withholding agent shall withhold the income tax from the payment or the amount due and payable.

APPENDIX III

TAXATION AND FOREIGN EXCHANGE

The Circular on Issues Related to the Withholding and Remittance of Enterprise Income Tax on Dividends Paid by Chinese Resident Enterprises to Overseas Non-resident Enterprises Which Hold H Shares (Guo Shui Han [2008] No. 897) (《關於中國居民企業向境外H股非居民企業股東派發股息代扣代繳企業所得稅有關問題的通知》(國稅函[2008]897號)) promulgated by the State Administration of Taxation on November 6, 2008, further clarified that, when PRC-resident enterprises pay dividends of 2008 and thereafter, enterprise income tax shall be withheld at the rate of 10% in respect of dividends paid to overseas non-resident enterprise shareholders which hold H shares. In addition, the Response to Questions on Levying Enterprise Income Tax on Dividends Derived by Non-resident Enterprise from Holding B-shares (Guo Shui Han [2009] No. 394) (《國家稅務總局關於非居民企業取得B股等股票股息徵收企業所得稅問題的批復》(國稅函[2009]394號)) issued by the State Administration of Taxation on July 24, 2009 further provides that any PRC-resident enterprise that is listed on overseas stock exchanges must withhold enterprise income tax at a rate of 10% on dividends of 2008 and thereafter that it distributes to non-resident enterprises. Such tax rate may be changed pursuant to the tax treaty or agreement that China has concluded with relevant jurisdictions, where applicable.

Pursuant to the Arrangement between the Mainland China and the Hong Kong Special Administrative Region for the Avoidance of Double Taxation and the Prevention of Fiscal Evasion with respect to Taxes on Income (《內地和香港特別行政區關於對所得避免雙重徵稅和防止偷漏稅的安排》) (hereinafter referred to as the "the Arrangement"), which was signed on August 21, 2006, the PRC government may impose tax on dividends payable by a PRC company to Hong Kong residents (including natural person and legal entity) subject to a maximum of 10% of the gross amount of dividends payable, or 5% for Hong Kong residents directly holding 25% or more of equity interest in such PRC company. The Fifth Protocol of the Arrangement between the Mainland of China and the Hong Kong Special Administrative Region on the Avoidance of Double Taxation and the Prevention of Fiscal Evasion (《<內地和香港特別行政區關於對所得避免雙重徵稅和防止偷漏稅的安排>第五議定書》), which came into effect on December 6, 2019, adds a criteria for the qualification of entitlement to enjoy treaty benefits. Although there may be other provisions under the Arrangement, the treaty benefits under the criteria shall not be granted in the circumstance where relevant gains, after taking into account all relevant facts and conditions, are reasonably deemed to be one of the main purposes for the arrangement or transactions which will bring any direct or indirect benefits under this Arrangement, except when the grant of benefits under such circumstance is consistent with relevant objective and goal under the Arrangement.

Tax Treaties

Non-resident investors residing in jurisdictions which have entered into treaties or adjustments for the avoidance of double taxation with the PRC might be entitled to a reduction of the Chinese corporate income tax imposed on the dividends received from PRC companies. The PRC currently has entered into Avoidance of Double Taxation Treaties or Arrangements with a number of countries and regions including Hong Kong Special Administrative Region, Macau Special Administrative Region, Australia, Canada, France, Germany, Japan, Malaysia, the Netherlands, Singapore, the United Kingdom and the United States. Non-PRC resident enterprises entitled to preferential tax rates in accordance with the relevant taxation treaties or arrangements are required to apply to the Chinese tax authorities for a refund of the corporate income tax in excess of the agreed tax rate, and the refund application is subject to approval by the Chinese tax authorities.

APPENDIX III

TAXATION AND FOREIGN EXCHANGE

Share Transfer-Related Tax

Individual Investors

According to Individual Income Tax Law of the People's Republic of China (《中華人民共和國個人所得稅法》) and Implementation Regulations of the Individual Income Tax Law of the People's Republic of China (《中華人民共和國個人所得稅法實施條例》), the gains realized from the disposal of equity interests in PRC resident enterprise is subject to individual income tax rate of 20%.

According to Notice of the Ministry of Finance and the State Administration of Taxation concerning the Continued Individual Income Tax Exemption for Individuals' Proceeds from Share Transfers (Cai Shui Zi [1998] No. 61) (《財政部、國家稅務總局關於個人轉讓股票所得繼續暫免徵收個人所得稅的通知》(財稅字[1998]61號)), which was promulgated and implemented on March 30, 1998 by the Ministry of Finance and the State Administration of Taxation, from January 1, 1997 onwards, the income from transfer of shares of listed companies by individuals continues to be provisionally exempted from individual income tax.

The Circular of Issues concerning the Individual Income Tax on Individuals' Income from the Transfer of Restricted Shares of Listed Companies (Cai Shui [2009] No. 167) (《關於個人轉讓上市公司限售股所得徵收個人所得稅有關問題的通知》(財稅字[2009]167號)) which was jointly promulgated on December 31, 2009 by the Ministry of Finance, the State Administration of Taxation and the CSRC, provided that income from the transfer of shares of listed companies on relevant domestic stock exchanges by individuals shall continue to be exempted from income tax, except the relevant restricted shares as defined in Supplemental Circular of Issues concerning the Individual Income Tax on Individuals' Income from the Transfer of Restricted Shares of Listed Companies (Cai Shui [2010] No. 70) (《關於個人轉讓上市公司限售股所得徵收個人所得稅有關問題的補充通知》(財稅[2010]70號)). As of the Latest Practicable Date, foresaid provisions don't specify whether income tax on transfer of shares of a PRC resident enterprise listed on an overseas stock exchange by non-PRC resident would be levied.

Enterprise Investors

In accordance with the Enterprise Income Tax Law of the People's Republic of China (《中華人民共和國企業所得稅法》) and the Implementation Regulations of the Enterprise Income Tax Law of the People's Republic of China (《中華人民共和國企業所得稅法實施條例》), a non-PRC resident enterprise is generally subject to enterprise income tax of 10% on PRC-sourced income (including gains derived from disposal of equity interests in PRC resident enterprise), if such non-PRC resident enterprise has no office or premises established in China or the income derived or accrued has no de facto relationship with the office or premises established. The aforesaid income tax payable by non-PRC resident enterprises shall be withheld at source, with the payer of the income being the withholding agent. When making such payment or when such payment becomes due and payable, the withholding agent shall withhold the income tax from the payment or the amount due and payable.

APPENDIX III

TAXATION AND FOREIGN EXCHANGE

Stamp Duty

Pursuant to the Provisional Regulations of the People's Republic of China on Stamp Duty (《中華人民共和國印花稅暫行條例》) which was amended on January 8, 2011 and the Implementation Rules for the Provisional Regulations of the People's Republic of China Concerning Stamp Duty (《中華人民共和國印花稅暫行條例施行細則》) which was implemented on October 1, 1988, PRC stamp duty only applies to specific taxable document executed or received within the PRC, having legally binding force in the PRC and protected under the PRC laws, thus the requirements of the stamp duty imposed on the transfer of shares of PRC listed companies shall not apply to the acquisition and disposal of H Shares by non-PRC investors outside of the PRC.

Estate Duty

As of the date of this document, no estate duty has been levied in the PRC under the PRC laws.

For further information, please refer to the section headed "Regulatory Overview" of this Document.

TAXATION IN HONG KONG

Tax on Dividends

Under the current practice of the Inland Revenue Department of Hong Kong, no tax is payable in Hong Kong in respect of dividends paid by us.

Capital Gains and Profit Tax

No tax is imposed in Hong Kong in respect of capital gains from the sale of H Shares. However, trading gains from the sale of the H Shares by persons carrying on a trade, profession or business in Hong Kong, where such gains are derived from or arise in Hong Kong from such trade, profession or business will be subject to Hong Kong profits tax, which is currently imposed at the maximum rate of 16.5% on corporations and at the maximum rate of 15% on unincorporated businesses. Certain categories of taxpayers (for example, financial institutions, insurance companies and securities dealers) are likely to be regarded as deriving trading gains rather than capital gains unless these taxpayers can prove that the investment securities are held for long-term investment purposes. Trading gains from sales of H Shares effected on the Hong Kong Stock Exchange will be considered to be derived from or arise in Hong Kong. Liability for Hong Kong profits tax would thus arise in respect of trading gains from sales of H Shares effected on the Hong Kong Stock Exchange realized by persons carrying on a business of trading or dealing in securities in Hong Kong.

APPENDIX III**TAXATION AND FOREIGN EXCHANGE**

Stamp Duty

Hong Kong stamp duty, currently charged at the ad valorem rate of 0.1% on the higher of the consideration for or the market value of the H Shares, will be payable by the purchaser on every purchase and by the seller on every sale of Hong Kong securities, including H Shares (in other words, a total of 0.2% is currently payable on a typical sale and purchase transaction involving H Shares). In addition, a fixed duty of HK\$5.00 is currently payable on any instrument of transfer of H Shares. Where one of the parties is a resident outside Hong Kong and does not pay the ad valorem duty due by it, the duty not paid will be assessed on the instrument of transfer (if any) and will be payable by the transferee. If no stamp duty is paid on or before the due date, a penalty of up to ten times the duty payable may be imposed.

Estate Duty

The Revenue (Abolition of Estate Duty) Ordinance 2005 came into effect on February 11, 2006 in Hong Kong, pursuant to which no Hong Kong estate duty is payable and no estate duty clearance papers are needed for an application of a grant of representation in respect of holders of H Shares whose deaths occur on or after February 11, 2006.

FOREIGN EXCHANGE

Please refer to the section headed "Regulatory Overview" of this Document.

APPENDIX IV

SUMMARY OF PRINCIPAL LEGAL AND REGULATORY PROVISIONS

THE PRC LEGAL SYSTEM

The PRC legal system is based on the Constitution of the People's Republic of China (the "Constitution") and is made up of written laws, administrative regulations, local regulations, separate regulations, autonomous regulations, departmental rules, rules of local governments, international treaties of which the PRC Government is a signatory and other regulatory documents. Court judgments do not constitute legally binding precedents, although they are used for the purposes of judicial reference and guidance.

Pursuant to the Constitution and the Legislation Law of the People's Republic of China ("Legislation Law"), the National People's Congress ("NPC") and its Standing Committee ("Standing Committee of the NPC") exercise the legislative power of the State. The NPC formulates and amends basic laws governing criminal, civil, State organs and other matters. The Standing Committee of the NPC formulates and amends laws other than those required to be enacted by the NPC and to supplement and amend parts of the laws enacted by the NPC during adjournment of the NPC, provided that such supplements and amendments are not in conflict with the basic principles of such laws.

The State Council is the highest organ of state administration and has the power to formulate administrative regulations based on the Constitution and laws.

The people's congresses of the provinces, autonomous regions and municipalities and their standing committees may formulate local regulations based on the specific circumstances and actual needs of their respective administrative areas, provided that such local regulations do not contravene any provision of the Constitution, laws or administrative regulations.

The people's congresses of cities divided into districts and their respective standing committees may formulate local regulations on aspects such as urban and rural construction and management, environmental protection and historical and cultural protection based on the specific circumstances and actual needs of such cities, provided that such local regulations do not contravene any provision of the Constitution, laws, administrative regulations and local regulations of their respective provinces or autonomous regions. People's congresses of national autonomous areas have the power to enact autonomous regulations and separate regulations in light of the political, economic and cultural characteristics of local ethnic groups. The autonomous regulations and separate regulations of autonomous regions shall come into force after being submitted to the Standing Committee of the National People's Congress for approval. The autonomous regulations and separate regulations of autonomous prefectures or autonomous counties shall come into force after being submitted to the Standing Committee of the People's Congresses of provinces, autonomous regions and municipalities for approval.

APPENDIX IV

SUMMARY OF PRINCIPAL LEGAL AND REGULATORY PROVISIONS

The ministries, commissions, PBoC, NAO and the subordinate institutions with administrative functions directly under the State Council may formulate departmental rules within their respective authority based on the laws and the administrative regulations, decisions and orders of the State Council.

The people's governments of the provinces, autonomous regions, municipalities and cities or autonomous prefectures divided into districts may formulate rules and regulations based on the laws, administrative regulations and local regulations of such provinces, autonomous regions or municipalities.

The Constitution has the highest legal effect, and any laws, administrative regulations, local laws and regulations, autonomous regulations as well as separate regulations and rules shall not contravene the Constitution. Laws have higher legal authority than administrative regulations, local laws and regulations. Administrative regulations have higher legal authority than local regulations and rules. Local regulations have higher legal authority than local government regulations at the same level or at a lower level. The regulations formulated by the people's governments of provinces or autonomous regions have higher legal authority than those formulated by the people's government of cities divided into districts and autonomous prefectures within the administrative areas of provinces and autonomous regions.

The NPC has the right to alter or revoke inappropriate laws enacted by its Standing Committee, and has the right to revoke any autonomous regulations or separate regulations approved by the Standing Committee of the NPC but contrary to the provisions of the Constitution or the Legislation Law. The Standing Committee of the NPC has the right to revoke administrative regulations that contravene the Constitution and laws, and to revoke annul local laws and regulations that contravene the Constitution, laws and administrative regulations, as well as to revoke the autonomous regulations and separate regulations approved by the Standing Committee of the People's Congresses of provinces, autonomous regions and municipalities but in violation of the Constitution and the Legislation Law. The State Council has the right to alter or revoke inappropriate department regulations and local government regulations. The People's Congresses of provinces, autonomous regions and municipalities have the right to alter or revoke inappropriate local laws and regulations enacted or approved by their Standing Committees. The people's governments of provinces and autonomous regions have the right to alter or revoke inappropriate regulations formulated by the people's governments at a lower level.

According to the Constitution, the power to interpret laws is vested in the Standing Committee of the NPC. Pursuant to the Resolution of the Standing Committee of the NPC Providing an Improved Interpretation of the Law (《全國人民代表大會常務委員會關於加強法律解釋工作的決議》) effective on June 10, 1981, in cases where the limits of articles of laws need to be further defined or additional stipulations need to be made, the Standing Committee of the NPC should provide interpretations or make stipulations by means of decrees. Issues related to the specific application of laws and decrees in a court trial and a prosecution process of the procuratorates should be interpreted by the Supreme People's Court and the Supreme

APPENDIX IV

SUMMARY OF PRINCIPAL LEGAL AND REGULATORY PROVISIONS

People’s Procuratorate, respectively. The State Council and the competent departments shall be responsible for the interpretation of the specific application of other laws and decrees that are not in the course of trial and prosecutorial work. Where local laws and regulations need to be further defined or supplemented, the Standing Committee of the People’s Congresses of provinces, autonomous regions, or municipalities that formulated the laws and regulations shall interpret or make a provision. Any specific application of local laws and regulations shall be interpreted by the competent departments of the people’s governments of provinces, autonomous regions, or municipalities. The Supreme People’s Court has the right to give a general explanation to the issues concerning the specific application of laws and decrees in the judicial work of the court. The State Council and its ministries and commissions are also vested with the power to interpret the administrative regulations and departmental rules which they have promulgated. At the regional level, the power to interpret regional laws, regulations and administrative regulations is vested in the regional legislative and administrative authorities which promulgate such laws, regulations and administrative regulations.

THE PRC JUDICIAL SYSTEM

Under the Constitution and the Law of Organization of the People’s Courts of the PRC (《中華人民共和國法院組織法》), the PRC judicial system is made up of the Supreme People’s Court, the local people’s courts at all levels, the military courts and other special people’s courts.

The Supreme People’s Court is the highest judicial authority. The local people’s courts are divided into three levels, namely, the higher people’s courts, the intermediate people’s courts and the primary people’s courts. Special people’s courts include, among others, military courts and maritime courts, intellectual property courts, and financial courts. The Supreme People’s Court shall supervise the judicial work of the local people’s courts at all levels and special people’s courts, and people’s courts at higher levels shall supervise the judicial work of people’s courts at lower levels.

The Civil Procedure Law of the PRC (《中華人民共和國民事訴訟法》, the “PRC Civil Procedure Law”) enacted by the NPC in April 1991 and amended by the Standing Committee of the NPC in October 2007, August 2012 and June 2017, respectively, prescribes the conditions for instituting a civil procedure, the jurisdiction of the people’s courts, the procedures for conducting the civil procedure, and the procedures for enforcement of a civil judgment or ruling. All parties to a civil procedure conducted within the PRC must abide by the PRC Civil Procedure Law. A civil case is generally heard by the court located in the defendant’s place of domicile. The parties to a contract may, by a written agreement, choose a people’s court of jurisdiction located at the places directly connected with the disputes, such as the defendant’s place of domicile, the place where the contract is executed or signed, the plaintiff’s place of domicile or the place where the object is located, provided that such choice may not contravene the provisions of the PRC Civil Procedure Law regarding hierarchical jurisdiction and exclusive jurisdiction.

APPENDIX IV

SUMMARY OF PRINCIPAL LEGAL AND REGULATORY PROVISIONS

Generally, foreign nationals or enterprises shall have equal procedural rights and obligations as citizens or enterprises of the PRC. If any party to a civil procedure refuses to abide by a judgment or ruling made by a people's court or an award made by an arbitration tribunal in the PRC, the other party may apply to the people's court for the enforcement of the same within two years.

Where a party applies for enforcement of a legally effective judgement or ruling made by a people's court, and the opposite party or his property is not within the territory of the People's Republic of China, the applicant may directly apply to a foreign court with jurisdiction for recognition and enforcement of the judgement or ruling, or the people's court may, in accordance with the provisions of international treaties to which the PRC is a signatory or in which the PRC is a participant or the principle of reciprocity, request recognition and enforcement by a foreign court.

Where a legally effective judgment or ruling made by a foreign court needs to be recognized and enforced by the people's court of the PRC, the parties involved may directly apply to an intermediate people's court of the PRC with jurisdiction for recognition and enforcement, or the foreign court may, in accordance with the provisions of international treaties entered into or acceded to by that country and the PRC or according to the principle of reciprocity, request the people's court to recognize and enforce it. For a legally effective judgment or ruling made by a foreign court applying for or requesting recognition and enforcement, the people's court shall, after having examined it in accordance with the international treaties entered into or acceded to by the PRC or according to the principle of reciprocity and having arrived at the conclusion that it does not contravene the basic principles of the laws of the PRC nor violate its sovereignty, security or public interests, recognize the validity of such judgment or ruling, and, if required, issue a writ of enforcement and enforce it in accordance with the relevant provisions of this Law. In the event that the judgment or ruling contravenes the basic principles of the laws of the PRC or violates its sovereignty, security or public interests, such judgment or ruling shall not be recognized or enforced.

According to the Arrangement on Reciprocal Recognition and Enforcement of Judgments in Civil and Commercial Matters by the Courts of the Mainland and of the Hong Kong Special Administrative Region Pursuant to Choice of Court Agreements Between Parties Concerned (《關於內地與香港特別行政區法院相互認可和執行當事人協議管轄的民商事案件判決的安排》) released by the Supreme People's Court on July 3, 2008 and effective from August 1, 2008, in the case of an enforceable final judgment on the payment amount made between the court of the Mainland and the court of the Hong Kong Special Administrative Region in a civil or commercial case with written jurisdiction agreement, any party concerned may apply to the people's court of the Mainland or the court of the Hong Kong Special Administrative Region for recognition and enforcement based on this arrangement.

APPENDIX IV

SUMMARY OF PRINCIPAL LEGAL AND REGULATORY PROVISIONS

THE PRC COMPANY LAW, THE SPECIAL REGULATIONS AND THE MANDATORY PROVISIONS

A joint stock company incorporated in the PRC and listed on the Hong Kong Stock Exchange shall mainly comply with the following three laws and regulations of the PRC:

The Company Law of the People’s Republic of China (the “PRC Company Law”), which was promulgated by the Standing Committee of the NPC in December 1993 and came into force in July 1994, and was revised by the Standing Committee of the NPC in December 1999, August 2004, October 2005, December 2013 and October 2018, respectively. The latest revised PRC Company Law has taken effect from October 26, 2018.

The Special Regulations of the State Council on Overseas Share Offering and Listing of Joint Stock Companies (the “Special Regulations”), which were enacted and promulgated by the State Council on August 4, 1994 pursuant to Articles 85 and 155 of the PRC Company Law of (1993), and were applicable to the issuance of shares to overseas investors by and overseas listing of joint stock companies.

The Mandatory Provisions for Articles of Association of Companies to be Listed Overseas (the “Mandatory Provisions”), which were jointly promulgated by China Securities Regulatory Commission and the State Commission for Restructuring Economic in September 1994, and set forth the clauses that must be stated in the articles of association of a joint stock limited company seeking an overseas listing. Accordingly, the Mandatory Provisions have been incorporated in the Articles of Association of the Company.

Set out below is a summary of the major provisions of the PRC Company Law, the Special Regulations and the Mandatory Provisions.

GENERAL PROVISIONS

A joint stock limited company refers to a corporate legal person incorporated under the PRC Company Law with its registered capital divided into shares of equal nominal value. The shareholders of the joint stock limited company shall bear liability for the company to the extent of the shares they subscribe for, and the joint stock limited company shall bear liability for the debts of the company with all its assets.

INCORPORATION

A joint stock limited company may be incorporated by promotion or subscription.

A company shall have a minimum of two but no more than 200 people as its promoters, and over half of the promoters must be resident within the PRC.

APPENDIX IV

SUMMARY OF PRINCIPAL LEGAL AND REGULATORY PROVISIONS

For joint stock limited companies incorporated by way of promotion, the promoters shall subscribe in writing for the shares required to be subscribed for by them and pay up their capital contributions under the articles of association. Procedures relating to the transfer of titles to non-monetary assets shall be duly completed if such assets are to be contributed as capital.

For joint stock limited companies incorporated by way of subscription, after the subscription monies for the share issue have been paid in full, a capital verification institution established under the PRC laws must be engaged to conduct a capital verification and furnish a certificate thereof. The promoters shall preside over and convene an inauguration meeting within 30 days from the date of the full payment of subscription monies. The promoters shall inform the subscribers of or announce the date of the meeting 15 days before the inauguration meeting was convened.

Within 30 days after conclusion of the inauguration meeting, the board of directors shall apply to the company registration authority for registration of the establishment of the joint stock limited company. The joint stock limited company is formally established and has the status of a legal person after a business license has been issued by the relevant registration authority.

ISSUE OF SHARES

The issuance of shares of joint stock limited company shall be conducted in accordance with the principles of fairness and justice so that each of the shares of the same class shall carry the same rights. For shares issued at the same time and within the same class, the conditions and price per share must be the same; for the shares subscribed by an entity or an individual, the price per share paid must be the same. The share offering price may be equal to or greater than the nominal value of the share, but may not be less than the nominal value.

A joint stock limited company may offer shares to specific and non-specific overseas investors and list its shares overseas upon approval from the securities commission of the State Council. Under the Special Regulations, shares issued to foreign investors by joint stock companies and listed overseas are known as overseas listed foreign shares; while shares issued to domestic investors by joint stock companies that also issue overseas listed foreign shares are known as domestic shares. Upon approval of the securities regulatory authority of the State Council, a Company issuing overseas listed foreign shares in total shares determined by the issuance plan may agree with underwriters in the underwriting agreement to retain not more than 15% of the number of overseas listed foreign shares proposed to be raised outside the underwriting amount. The issuance of the retained shares is deemed to be a part of this issuance.

APPENDIX IV

SUMMARY OF PRINCIPAL LEGAL AND REGULATORY PROVISIONS

REGISTERED SHARES

Under the PRC Company Law, shareholders may make capital contributions in the form of money or appraised non-monetary assets including real objects, intellectual property and land use right which can be appraised in money and transferred according to laws. Under the Special Regulations, overseas listed and foreign invested shares issued shall be in registered form, denominated in Renminbi and subscribed for in a foreign currency. Domestic shares issued shall be in registered form.

Under the PRC Company Law, a company issuing registered share certificates shall maintain a shareholder registry which sets forth the following matters:

- (I) the name and domicile of each shareholder;
- (II) the number of shares held by each shareholder;
- (III) the serial numbers of shares held by each shareholder; and
- (IV) the date on which each shareholder acquired the shares.

INCREASE OF CAPITAL

Under the PRC Company Law, where a company is issuing new shares, resolutions shall be passed at the general meeting in respect of the class and amount of the new shares, the issue price of the new shares, the commencement and end dates for the issue of the new shares and the class and amount of the new shares proposed to be issued to existing shareholders. When a company launches a public issue of new shares to the public upon the approval by the securities regulatory authorities of the State Council, a new share offering prospectus and financial and accounting reports must be announced and a share subscription form must be prepared. After the new shares issued by the company have been paid up, the change must be registered with the company registration authority and a public announcement shall be made.

REDUCTION OF CAPITAL

When reducing its registered capital, the company must prepare a balance sheet and an inventory of property. Within ten (10) days of the date on which the resolution on reducing registered capital is made, and a public announcement shall be made within thirty (30) days. The creditors of the company may require the company to repay its debts or provide guarantees within 30 days of receipt of the notification or within 45 days of the date of the announcement if he/she/it has not received any notification.

APPENDIX IV**SUMMARY OF PRINCIPAL LEGAL AND REGULATORY PROVISIONS**

REPURCHASE OF SHARES

Pursuant to the PRC Company Law, a joint stock limited company may not repurchase its own shares other than for one of the following purposes:

- (I) reducing the company's registered capital;
- (II) merging with another company holding Shares in the Company;
- (III) to use shares for employee stock ownership plan or equity incentives;
- (IV) a shareholder requesting the company to purchase the shares held by him since he objects to a resolution of the shareholders' meeting on the combination or division of the company;
- (V) utilizing the shares for conversion of corporate bonds which are convertible into shares issued by a listed company; and
- (VI) where it is necessary for a listed company to maintain its corporate value and shareholders' equity.

A resolution of a shareholders' general meeting is required for the repurchase of our shares by a company under either of the circumstances stipulated in item (I) or item (II) above; for a company's repurchase of our shares under any of the circumstances stipulated in item (III), item (V) or item (VI) above, a resolution of a meeting of the board of directors shall be made by more than two-thirds of directors attending the meeting according to the provisions of the company's articles of association or as authorized by the shareholders' general meeting. The company's shares acquired under the circumstance stipulated in item (I) hereof shall be deregistered within ten days from the date of acquisition of shares; the shares shall be assigned or deregistered within six months if the repurchase of our shares is made under the circumstances stipulated in either item (II) or item (IV); and the shares of the company held in total by the company after the repurchase of shares under any of the circumstances stipulated in item (III), item (V) or item (VI) shall not exceed 10% of the company's total outstanding shares, and shall be assigned or deregistered within three years.

TRANSFER OF SHARES

Shares held by shareholders may be transferred in accordance with the relevant laws and regulations. Under the PRC Company Law, a shareholder should effect a transfer of his shares on a stock exchange established in accordance with laws or by any other means as required by the State Council.

APPENDIX IV

SUMMARY OF PRINCIPAL LEGAL AND REGULATORY PROVISIONS

Registered shares may be transferred after the shareholders endorse the back of the share certificates or in any other manner specified by the laws or administrative regulations. After the transfer, the transferee's name and address shall be registered in the share register by the company.

Change of the share register described in the preceding paragraph shall not be registered within 20 days before convening of a shareholders' general meeting or five days prior to the base date on which the company decides to distribute dividends. However, where the laws have other provisions on change of the share register of listed companies, such provisions shall prevail.

According to the Mandatory Provisions, change of the share register arising from share transfer shall not be registered within 30 days before convening of a shareholders' general meeting or within five days prior to the base date on which the company decides to distribute dividends.

Under the PRC Company Law, our shares held by promoters may not be transferred within one year of the establishment of the company. Shares of the company issued prior to the public issuance of shares may not be transferred within one year of the date of the shares of the company are listed and traded on a stock exchange. The directors, supervisors and senior management personnel of the company shall report to the company their shareholdings in the company and changes thereof and shall not transfer more than 25% of the total shares held by them in the company per annum during their terms of office; the shares they hold in the company shall not be transferred within one year from the date on which the shares of the company are listed and traded. The shares they held in the company also cannot be transferred within half a year after such persons have left office.

Shareholders

Under the PRC Company Law and the Mandatory Provisions, the rights of holders of ordinary shares of a joint stock limited company include:

- (I) attend or appoint a proxy to attend shareholders' general meetings, and to exercise corresponding voting rights;
- (II) to transfer the shares in accordance with laws, administrative regulations and provisions of the articles of associations;
- (III) to inspect the articles of association, share register, counterfoil of company debentures, minutes of shareholders' general meetings, board resolutions, resolutions of the Supervisory Committee and financial and accounting reports and to supervise, manage and make suggestions or inquiries in respect of the company's operations;

APPENDIX IV

SUMMARY OF PRINCIPAL LEGAL AND REGULATORY PROVISIONS

- (IV) if any resolution of the shareholders' general meetings or board of directors violates the articles of association, the shareholders shall request the people's court to cancel such resolutions;
- (V) to receive dividends and other kinds of benefits distributions as determined by the number of shares held by them;
- (VI) to participate in the distribution of the remaining assets of the company based on the number of shares held in the event of the company's dissolution or liquidation; and
- (VII) other rights provided for in laws, administrative regulations, other regulatory documents and the articles of association.

The obligations of shareholders include the obligation to abide by the company's articles of association, to pay the subscription monies in respect of the shares subscribed for and the method of subscription, to be liable for the company's debts and liabilities to the extent of the amount of his or her subscribed shares and any other shareholder obligation specified in the laws, administrative regulations and the company's articles of association.

SHAREHOLDERS' GENERAL MEETINGS

The shareholders' general meeting of a joint stock limited company is composed by all shareholders. The shareholders' general meeting is the organ of authority of the company, which exercises its functions and powers in accordance with the PRC Company Law.

Under the PRC Company Law and the Mandatory Provisions, the shareholders' general meeting shall exercise the following major functions and powers:

- (I) to decide on the company's operational objectives and investment plans;
- (II) to elect and replace Directors and Supervisors which are not appointed as representatives of the employees and to decide on the remuneration of the relevant Directors and Supervisors;
- (III) to examine and approve reports made by the Board;
- (IV) to review and approve the reports of the Supervisory Committee;
- (V) to review and approve the company's annual financial budgets and final accounts;
- (VI) to review and approve the company's profit distribution proposals and loss recovery proposals;
- (VII) to decide on any increase or reduction of the company's registered capital;

APPENDIX IV

SUMMARY OF PRINCIPAL LEGAL AND REGULATORY PROVISIONS

- (VIII) to decide on the issue of corporate bonds;
- (IX) to decide on merger, division, dissolution and liquidation of the company or change of its corporate form;
- (X) amendments to the Articles of Association;
- (XI) to decide on the company's engagement, dismissal or discontinuation of the appointment of the accounting firm;
- (XII) other functions and powers stipulated by the laws, administrative regulations and the Article of Association.

Pursuant to the PRC Company Law, a shareholders' general meeting is required to be held once every year. Under any of the following circumstances, the company shall convene an extraordinary general meeting within 2 months from the date of occurrence:

- (I) the number of directors is less than the number stipulated by the laws or less than two thirds of the number specified in the articles of association;
- (II) the outstanding losses of the company amounted to one-third of the company's total paid-in share capital;
- (III) Shareholders who individually or jointly hold above 10% of the shares of the company have requested to convene the meeting;
- (IV) the Board deems it necessary to convene the meeting;
- (V) the Supervisory Committee proposes to convene the meeting;
- (VI) any other circumstances as provided for in the articles of association.

Pursuant to the PRC Company Law, a shareholders' general meeting shall be convened by the board of directors and chaired by the chairman of the board. If the chairman of the Board is unable to perform his/her duties or fails to perform his/her duties, the vice chairman of the Board shall convene and preside over the meeting of the Board; if the vice chairman of the Board is unable to perform his/her duties or fails to perform his/her duties, more than half of the directors shall jointly recommend a director to convene and preside over the meeting of the Board. If the board is unable to perform or fails to perform its duties of convening the shareholders' general meeting, the supervisory committee shall convene and preside over the meeting in a timely manner; if the Supervisory Committee fails to convene and preside over such meeting, shareholders individually or in aggregate holding more than 10% of the company's shares for more than 90 consecutive days may convene and preside over such meeting by themselves.

APPENDIX IV

SUMMARY OF PRINCIPAL LEGAL AND REGULATORY PROVISIONS

Pursuant to the PRC Company Law, notice of shareholders' general meetings stating the time and venue of and matters to be considered at the meeting shall be given to all shareholders 20 days before the meeting; notice of extraordinary general meetings shall be given to all shareholders 15 days before the meeting; in case of meetings for issuance of bearer shares, a notice stating the time and venue of and matters to be considered at the meeting shall be announced 30 days before the meeting.

Pursuant to the Mandatory Provisions, rights conferred to class shareholders may be varied or abrogated upon approval by way of a special resolution at a general meeting and by more than two thirds of the shareholding with voting rights at a separate class meeting convened by the affected class shareholders.

According to the PRC Company Law, shareholders present at shareholders' general meeting shall have one vote for each share they hold, save that the company's shares held by the company are not entitled to any voting rights. An accumulative voting system may be adopted for the election of directors and supervisors at the general meeting pursuant to the provisions of the articles of association or a resolution of the general meeting. Under the accumulative voting system, when the shareholders' general meeting elects directors or supervisors, each share has the same voting rights as the number of directors or supervisors to be elected, and the voting rights owned by shareholders can be used collectively.

Under the PRC Company Law and the Mandatory Provisions, the passing of any resolution of a shareholders' general meeting requires affirmative votes of shareholders representing more than half of the voting rights represented by the shareholders who attend the general meeting. However, the resolutions made by the shareholders' general meeting on the following matters must be passed by more than two-thirds of the voting rights held by the shareholders present at the meeting:

- (I) amendments to the articles of association;
- (II) the increase or decrease of the registered capital;
- (III) the issuance of any class of shares, warrants and other similar securities;
- (IV) the issuance of corporate bonds;
- (V) merger, division, dissolution and liquidation of the company or change of its corporate form;
- (VI) other matters that need to be passed by special resolutions that are determined by ordinary resolution of the shareholders' general meeting to have a significant impact on the company.

APPENDIX IV

SUMMARY OF PRINCIPAL LEGAL AND REGULATORY PROVISIONS

Under the PRC Company Law, the shareholders' general meeting shall make minutes of the meeting's decisions on the matters discussed at the meeting, and the chairperson and the directors attending the meeting shall sign the minutes. The minutes shall be kept together with the shareholders' attendance register and the proxy forms.

BOARD OF DIRECTORS

According to the PRC Company Law, a joint stock limited company shall have a board of directors which shall consist of 5 to 19 members. Members of the board may include staff representatives, who shall be democratically elected by the company's staff at a staff representative assembly, general staff meeting or otherwise. The term of a director shall be stipulated in the articles of association, provided that no term of office shall last for more than three years. A director may be re-elected and re-appointed upon expiry of his/her term of office. Such director shall continue to perform his/her duties as a director in accordance with the laws, administrative regulations and the articles of association until a reelected director of the company takes office, if re-election is not conducted in a timely manner upon the expiry of his/her term of office or if the resignation of directors during his/her term of office results in the number of members of board being less than the quorum.

Under the PRC Company Law and the Mandatory Provisions, the board of directors may exercise the following functions and powers:

- (I) to convene shareholders' general meetings and report its performance at the shareholders' general meetings;
- (II) to execute resolutions of shareholders' general meetings;
- (III) to decide on the company's business plans and investment plans;
- (IV) to formulate proposal for the company's annual financial budgets and final accounts;
- (V) to formulate the company's profit distribution proposals and loss recovery proposals;
- (VI) to make plans for the increase or decrease of the registered capital of the company and for the issuance of corporate bonds;
- (VII) to formulate proposals for the merger, division or dissolution of the company and change of corporate form;
- (VIII) to decide on the internal management setup of the company;

APPENDIX IV

SUMMARY OF PRINCIPAL LEGAL AND REGULATORY PROVISIONS

- (IX) to resolve on appointment, dismissal and remunerations of the general manager of the company, and as nominated by the general manager, to resolve on appointment, dismissal and remunerations of the company's deputy general managers and chief financial officer;
- (X) to formulate the company's basic management system;
- (XI) to formulate proposals for any amendment to the articles of association;
- (XII) any other functions and powers stipulated in the articles of association.

THE BOARD MEETING

Under the PRC Company Law, meetings of the board of directors of a joint stock limited company shall be convened at least twice each year, and the notice of each meeting shall be given to all directors and supervisors 10 days before the meeting. Interim board meetings may be proposed to be convened by shareholders representing more than one tenth of the voting rights, more than one-third of the directors or the supervisory committee. The chairman shall convene the meeting within 10 days of receiving such proposal, and preside over the board meeting.

Meetings of the Board of Directors shall be held only if more than half of the directors are present. Resolutions of the Board shall be passed by more than half of all directors. Resolutions of the Board shall be passed on a "one person one vote" basis. Meetings of the Board of Directors shall be attended by the directors in person. If a director is unable to attend the meeting for a reason, he/she may appoint another director by a written power of attorney specifying the scope of the authorization to attend the meeting on his behalf.

The directors shall be responsible for the resolutions of the Board. If a resolution of the Board of Directors violates the laws, administrative regulations or the articles of association or resolutions of the general meeting, and as a result of which the company sustains serious losses, the directors participating in the resolution are liable to compensate the company. However, if it can be proved that a director expressly objected to the resolution when the resolution was voted on, and that such objection was recorded in the minutes of the meeting, such director shall be relieved from that liability.

CHAIRMAN

Pursuant to the PRC Company Law, the Board of Directors shall appoint a chairman and may appoint a vice chairman. The chairman and the vice chairman shall be elected with approval of more than half of all the directors. The chairman shall convene and preside over board meetings and review the implementation of board resolutions. The vice chairman shall assist the chairman to perform his/her duties. If the chairman is unable to perform his/her duties or fails to perform his/her duties, the vice chairman shall perform the duties on behalf of the chairman; if the vice chairman is incapable of performing or not performing his/her duties, a director nominated by more than half of the directors shall perform his duties.

APPENDIX IV

SUMMARY OF PRINCIPAL LEGAL AND REGULATORY PROVISIONS

QUALIFICATION OF DIRECTORS

Pursuant to the PRC Company Law and Mandatory Provisions, anyone who is under any of the following circumstances shall not serve as a director in a company:

- (I) a person without or with limited capacity for civil conduct;
- (II) a person who has been convicted of an offence of corruption, bribery, embezzlement, misappropriation of property or destruction of the socialist economic order, or who has been deprived of his political rights due to his crimes, in each case where less than five years have elapsed since the date of completion of the sentence;
- (III) a director, factory director or manager of bankrupt and liquidated companies or enterprises whereby such person was personally liable for the bankruptcy of such companies or enterprises, and three years have not elapsed from which the liquidation of the companies or enterprises was completed;
- (IV) a legal representative of companies or enterprises which have had their business licenses revoked and the business of such companies or enterprises were compulsorily closed down due to a violation of laws in which such person was personally liable, and three years have not elapsed from which the business license of the company or enterprise was revoked;
- (V) a person who is liable for a relatively large amount of debts that are overdue;
- (VI) a person under investigation by judicial authorities for suspected violations of criminal law and the investigation is still ongoing;
- (VII) a person cannot assume the position of leader of an enterprise according to laws and administrative regulations;
- (VIII) a non-natural person;
- (IX) a person has been ruled as violations of the provisions of relevant securities regulations by the competent authority, involving fraud or dishonesty, and it does not exceed five years from the date of the ruling.

SUPERVISORY COMMITTEE

According to the PRC Company Law, a joint stock limited company shall have a Supervisory Committee composed of not less than three members. The Supervisory Committee shall consist of representatives of the shareholders and an appropriate proportion of representatives of the company's staff, of which the proportion of representatives of the company's staff shall not be less than one-third, and the actual proportion shall be determined in the articles of association. Representatives of the company's staff at the Supervisory Committee shall be democratically elected by the company's staff at the staff representative assembly, general staff meeting or otherwise.

APPENDIX IV

**SUMMARY OF PRINCIPAL LEGAL AND
REGULATORY PROVISIONS**

Directors and senior management members shall not act concurrently as supervisors.

Each term of office of the supervisors shall be three years, and the supervisors may hold a consecutive term upon re-election. A supervisor shall continue to perform his/her duties as a supervisor in accordance with the laws, administrative regulations and the articles of association until a duly re-elected supervisor takes office, if re-election is not conducted in a timely manner upon the expiry of his/her term of office or if the resignation of supervisors results in the number of supervisors being less than the quorum.

The Supervisory Committee shall have one chairman and may appoint a vice chairman. The chairman and the vice chairman of the Supervisory Committee shall be elected by more than half of the supervisors. The chairman shall convene and preside over meetings of the Supervisory Committee; if the chairman of the Supervisory Committee is unable to perform his/her duties or fails to perform his/her duties, the vice chairman of the Supervisory Committee shall convene and preside over the meetings of the Supervisory Committee; if the vice chairman of the Supervisory Committee is unable to perform his/her duties or fails to perform his/her duties, more than half of the supervisors shall jointly recommend a supervisor to convene and preside over the meetings of the Supervisory Committee.

The Supervisory Committee may exercise its powers:

- (I) to check the financial situations of the company;
- (II) to supervise the acts of the directors and senior management personnel in performing their duties to the company and propose the removal of those directors and senior management personnel who violate the laws, administrative regulations, the articles of association or resolutions of shareholders' general meetings;
- (III) to demand any director or senior management personnel who acts in a manner which is detrimental to the company's interests to rectify such behaviors;
- (IV) to propose the convening of extraordinary general meetings and, in case the Board of Directors does not perform the obligations to convene and preside over the shareholders' general meetings in accordance with this Law, to convene and preside over the shareholders' general meetings;
- (V) to propose motions to the shareholders' general meeting;
- (VIII) to bring actions against the directors and senior management personnel in accordance with Article 151 of the PRC Company Law;
- (VII) to exercise other functions and powers as specified in the articles of association.

Supervisors may be present at board meetings and make inquiries or proposals in respect of the resolutions of the Board of Directors. The Supervisory Committee may investigate any irregularities identified in the operation of the company and, when necessary, may engage an accounting firm to assist its work at the cost of the company.

APPENDIX IV

SUMMARY OF PRINCIPAL LEGAL AND REGULATORY PROVISIONS

MEETINGS OF THE SUPERVISORY COMMITTEE

Pursuant to the PRC Company Law, the meetings of the Supervisory Committee shall be held at least once every six months. Supervisors may propose to convene an extraordinary meeting of the Supervisory Committee. Resolutions of the Supervisory Committee shall be passed by more than half of the supervisors. The Supervisory Committee shall make minutes of the meeting's decisions on the matters discussed at the meeting, and the supervisors attending the meeting shall sign the minutes.

MANAGER AND SENIOR MANAGEMENT

Pursuant to the PRC Company Law, a joint stock limited company shall have a manager who shall be appointed or removed by the Board of Directors. The manager shall be accountable to the Board of Directors, may exercise the following functions and powers:

- (I) to take charge of the management the production, operation and administration of the company and arrange for the implementation of the resolutions of the Board of Directors;
- (II) to arrange for the implementation of the company's annual operation plans and investment proposals;
- (III) to formulate proposals for the establishment of the company's internal management organs;
- (IV) to formulate the fundamental management system of the company;
- (V) to formulate the company's specific rules and regulations;
- (VI) to recommend the appointment or dismissal of any deputy manager and any financial officer of the company;
- (VII) to appoint or dismiss management personnel (other than those required to be appointed or dismissed by the Board of Directors);
- (VIII) to exercise other functions and powers granted by the Board of Directors.

The manager shall be present at the meetings of the Board of Directors.

According to the PRC Company Law, senior management refers to the manager, deputy manager, financial officer, secretary to the board of a listed company and other personnel as stipulated in the articles of association.

APPENDIX IV

**SUMMARY OF PRINCIPAL LEGAL AND
REGULATORY PROVISIONS**

OBLIGATIONS OF DIRECTORS, SUPERVISORS AND SENIOR MANAGEMENT

Directors, supervisors and senior management are required under the PRC Company Law to comply with the relevant laws, regulations and the articles of association, and carry out their duties of loyalty and diligence. Directors, supervisors and senior management of the company are prohibited from abusing their authority in accepting bribes or other unlawful income and from misappropriating the company's property.

Directors and senior management of the company are prohibited from:

- (I) misappropriating company funds;
- (II) depositing company funds into accounts under their own names or the names of other individuals to deposit;
- (III) loaning company funds to others or providing guarantees in favor of others supported by the company's property in violation of the articles of association or without approval of the shareholders' general meeting or the Board of Directors;
- (IV) entering into contracts or transactions with the company in violation of the articles of association or without approval of the shareholders' general meeting;
- (V) using their position to procure business opportunities for themselves or others that should have otherwise been available to the company or operating businesses similar to that of the company for their own benefits or on behalf of others without approval of the shareholders' general meeting;
- (VI) accepting for their own benefit commissions from other parties dealing with the company;
- (VII) unauthorized divulgence of confidential information of the company;
- (VIII) other acts in violation of their duty of loyalty to the company.

Income generated by directors or senior management in violation of aforementioned shall be returned to the company. If a director, supervisor or senior management in carrying out his/her duties infringes any law, administrative regulation or the articles of association of the company, which results in damage to the company, that director, supervisor or senior management shall be liable for compensation.

APPENDIX IV

**SUMMARY OF PRINCIPAL LEGAL AND
REGULATORY PROVISIONS**

FINANCE AND ACCOUNTING

According to the PRC Company Law, a company shall establish its financial and accounting systems according to the laws, administrative regulations and the regulations of the financial departments of the State Council. A company shall prepare its financial and accounting reports at the end of each fiscal year, which reports shall be audited by accounting firm according to law. The financial and accounting reports shall be prepared in accordance with the laws, administrative regulations and the regulations of the financial departments of the State Council.

Under the PRC Company Law, a joint stock limited company is required to make available at the company for inspection by shareholders its financial report 20 days before its shareholders' annual general meeting; a joint stock limited company of which the shares are publicly offered must publish its financial report.

The company shall withdraw 10% of the annual after-tax profits as the statutory reserve fund of the company. Such withdrawal may be stopped when the statutory reserve fund of the company has accumulated to at least 50% of the registered capital of the company. If the statutory reserve fund is insufficient to make up for the losses of the preceding year, the profits of the current year shall first be used to make up for the said losses before any statutory reserve fund is withdrawn as per the preceding paragraph. After statutory reserve fund is withdrawn out of the after-tax profits, discretionary reserve fund may also be withdrawn out of the same as per a resolution made at a shareholders' general meeting. After the joint stock limited company has made good its losses and made allocations to its discretionary common reserve fund, the remaining profits after taxation shall be distributed in proportion to the number of shares held by the shareholders, except for those which are not distributed in a proportionate manner as provided by the articles of association. The company shall not be entitled to any distribution of profits in respect of shares held by it. The reserve fund of a company shall be applied to make good the company's losses, expand its business operations or transfer to increase its capital. Upon the transfer of the statutory reserve fund into capital, the balance of the fund shall not be less than 25% of the registered capital of the company before such transfer.

Proceeds from shares issued by a joint stock limited company at a price above their nominal value and other revenues required by the financial departments of the State Council to be stated as capital reserve shall be accounted for as the capital reserve fund of the company. However, the capital reserve shall not be used to recover the losses of the company.

The company shall have no accounting books other than the statutory books. The company's assets shall not be deposited in any account opened under the name of an individual.

APPENDIX IV

SUMMARY OF PRINCIPAL LEGAL AND REGULATORY PROVISIONS

APPOINTMENT AND DISMISSAL OF ACCOUNTING FIRM

Pursuant to the PRC Company Law, the appointment or dismissal of an accounting firm responsible for the company's auditing shall be determined by shareholders at a shareholders' general meeting or the Board of Directors in accordance with the articles of association. The accounting firm should be allowed to make representations when the shareholders' general meeting or the Board of Directors conduct a vote on the dismissal of the accounting firm.

The company should provide true and complete accounting evidence, accounting books, financial and accounting reports and other accounting information to the engaged accounting firm without any refusal or withholding or falsification of information.

An accounting firm appointed by the company shall have the following rights:

- (I) to inspect, at any time, the company's account books, records or vouchers, and shall have the right to require the directors, managers or other senior management members to provide relevant data and explanations;
- (II) to require the company to take all reasonable measures to obtain documents and explanations from its subsidiaries necessary for the accounting firm to perform its duties;
- (III) to attend the shareholders' meetings, get notice of the meetings or other information related to the meetings that any shareholder has the right to receive, and deliver speeches at any shareholders' meeting on matters concerning its role as the accounting firm of the company.

The Special Regulations require a company to engage an independent accounting firm which complies with the relevant national regulations to audit the company's annual reports and to review and check other financial reports of the company. The accounting firm's term of office shall commence from the end of the shareholders' annual general meeting to the end of the next shareholders' annual general meeting.

PROFIT DISTRIBUTION

According to the PRC Company Law, a company shall not distribute profits before losses are covered and the statutory reserve fund is provided.

Pursuant to the Mandatory Provisions, a company shall appoint for holders of overseas listed foreign shares a recipient agent. The recipient agent shall collect on behalf of the shareholders concerned the dividends distributed and other funds payable by the company in respect of the overseas listed foreign shares.

APPENDIX IV

SUMMARY OF PRINCIPAL LEGAL AND REGULATORY PROVISIONS

AMENDMENT TO ARTICLES OF ASSOCIATION

Amendments to the articles of association shall be made in accordance with the laws, administrative regulations and procedures stipulated in the articles of association. The amendment to articles of association involving content of the Mandatory Provisions will only be effective upon approval of the department in charge of company examination and approval and the securities regulatory authorities authorized by the State Council, while the amendment to articles of association involving matters of company registration must be registered with the relevant authority in accordance with applicable laws.

DISSOLUTION AND LIQUIDATION

Pursuant to the PRC Company Law, a company shall be dissolved for any of the following reasons:

- (I) the term of its operation set out in the articles of association has expired or other events of dissolution specified in the articles of association have occurred;
- (II) if the shareholders' general meeting resolves to do so;
- (III) the company is dissolved by reason of its merger or division;
- (IV) the business license of the company is revoked or the company is ordered to close down or to be dissolved in accordance with the laws;
- (V) the company is dissolved by a people's court in response to the request of shareholders holding shares that represent more than 10% of the voting rights of all shareholders of the company, on the grounds that the operation and management of the company has suffered serious difficulties that cannot be resolved through other means, rendering ongoing existence of the company a cause for significant losses to the shareholders.

In the event of item (I) above, the company may carry on its existence by amending its articles of association. The amendments to the articles of association in accordance with the provisions described above shall require the approval of more than two-thirds of voting rights of shareholders attending a shareholders' general meeting.

Where the company is dissolved under the circumstances set forth in items (I), (II), (IV) or (V) above, it should establish a liquidation team to start liquidation within 15 days of the date on which the dissolution matter occurs. The liquidation team of the company shall be composed of directors or any other person determined by a shareholders' general meeting. If no liquidation team is established after the said timeframe, the creditors may apply to the people's court for appointment of relevant persons to establish a liquidation team to commence liquidation. The people's court should accept such application and form a liquidation team to conduct liquidation in a timely manner.

APPENDIX IV

**SUMMARY OF PRINCIPAL LEGAL AND
REGULATORY PROVISIONS**

The liquidation team may exercise following powers during the liquidation:

- (I) to dispose of the company's property and to prepare a balance sheet and an inventory of property, respectively;
- (II) to inform creditors by notice or announcement;
- (III) to deal with any outstanding businesses of the company related to liquidation;
- (IV) to pay any outstanding tax together with any tax arising during the liquidation process;
- (V) to settle the claims and debts;
- (VI) to handle the company's remaining property after its debts have been paid off; and
- (VII) to represent the company in any civil procedures.

The liquidation team shall notify the creditors within 10 days after its establishment and shall make announcements on newspapers within 60 days. The creditors shall declare their creditor's rights to the liquidation team within 30 days after receipt of the notice or 45 days after announcement if the creditors have not received the notice. During the period of the claim, the creditor shall explain all matters relevant to the creditor's rights he/she has claimed and provide relevant evidential documents. The liquidation team shall register the creditor's rights. The liquidation team shall not make any settlement to creditors during the period of the claim.

Upon disposal of the company's property and preparation of the required balance sheet and inventory of assets, the liquidation team shall draw up a liquidation plan and submit this plan to a shareholders' general meeting or a people's court for endorsement.

The remaining assets of the company, after payment of liquidation expenses, employee wages, social insurance expenses and statutory compensation, outstanding taxes and the company's debts, shall be distributed to shareholders in proportion to shares held by them. The company shall continue to exist during the liquidation period, although it cannot conduct operating activities that are not related to the liquidation. The company's property shall not be distributed to shareholders before repayments are made in accordance with the requirements described above.

Upon liquidation of the company's property and preparation of the required balance sheet and inventory of assets, if the liquidation team becomes aware that the company does not have sufficient assets to meet its liabilities, it must apply to a people's court for a declaration of bankruptcy in accordance with the laws. Following such declaration by the people's court, the liquidation team shall hand over the administration of the liquidation to the people's court.

APPENDIX IV

SUMMARY OF PRINCIPAL LEGAL AND REGULATORY PROVISIONS

Upon completion of the liquidation of the company, the liquidation team shall prepare a liquidation report and submit it to the shareholders' general meeting or a people's court for confirmation and the company registration authority to cancel the company's registration, and an announcement of its termination shall be published.

Members of the liquidation team are required to discharge their duties in good faith and perform their obligation of the liquidation in compliance with laws. Members of the liquidation team shall be prohibited from abusing their authority in accepting bribes or other unlawful income and from misappropriating the company's properties. Members of the liquidation team shall assume compensation liability if the company or creditors incur losses as a result of the deliberate or gross default of the said members.

OVERSEAS LISTING

The company should obtain approval from the CSRC prior to listing its shares overseas according to the Special Regulations. Subject to approval of the company's plans to issue overseas-listed foreign shares and domestic shares by the CSRC, the Board of Directors of the company may make arrangement to implement such plans for issuance, respectively, within fifteen months from the date of approval by the CSRC.

LOSS OF SHARE CERTIFICATES

According to the PRC Company Law, a shareholder may, in accordance with the public notice procedures set out in the PRC Civil Procedure Law, apply to a people's court if his share certificate(s) in registered form is either stolen, lost or destroyed, for a declaration that such certificate(s) will no longer be valid. After the people's court declares that such certificate(s) will no longer be valid, the shareholder may apply to the company for the issue of a replacement certificate(s).

In accordance with the Mandatory Provisions, where shareholders of overseas listed foreign shares lose their shares and apply for re-issuance, the matter may be dealt with in accordance with the laws, the rules of the stock exchange or other relevant provisions of the place where the original register of shareholders of overseas listed foreign shares is kept.

MERGER AND DIVISION

Merger of companies may be conducted by absorption or consolidation. If companies adopt the method of absorption, the absorbed company shall be dissolved. If companies are incorporated in the form of consolidation, the parties to the merger shall be dissolved.

The parties to the merger shall enter into a merger agreement and prepare a balance sheet and a list of properties. Within ten days of the date on which the resolution on merger is made, the creditors shall be notified by the company and a public announcement shall be made in the press within thirty days. The creditors may require the company to repay its debts or provide guarantees for covering the debts within 30 days of receipt of the notification or within 45 days of the date of the announcement if he/she/it has not received any notification; and in case of a merger, the credits and debts of the merging parties shall be assumed by the surviving or the new company.

APPENDIX IV

SUMMARY OF PRINCIPAL LEGAL AND REGULATORY PROVISIONS

In case of a division, the company's assets shall be divided and a balance sheet and an inventory of assets shall be prepared. Within ten days of the date on which the resolution on merger is made, the creditors shall be notified by the company and a public announcement shall be made in the press within thirty days. The liabilities of the company which have accrued prior to the division shall be jointly borne by the separated companies, unless otherwise stipulated in the agreement in writing entered into by the company with creditors in respect of the settlement of debts prior to division.

SECURITIES LAWS AND REGULATIONS

The PRC has promulgated a series of regulations that relate to the issue and trading of the shares and disclosure of information. In October 1992, the State Council established the Securities Committee and CSRC. The Securities Committee is responsible for coordinating the drafting of securities regulations, formulating securities-related policies, planning the development of securities markets, directing, coordinating and supervising all securities-related institutions in the PRC and administering the CSRC. The CSRC is the regulatory arm of the Securities Committee and is responsible for the drafting of regulatory provisions governing securities markets, supervising securities companies, regulating public offerings of securities by PRC companies in the PRC or overseas, regulating the trading of securities, compiling securities-related statistics and undertaking relevant research and analysis. In April 1998, the State Council merged these two departments, thereby reforming the CSRC.

On December 25, 1995, the State Council promulgated and implemented the Regulations of the State Council Concerning Domestic Listed Foreign Shares of Joint Stock Limited Companies (《國務院關於股份有限公司境內上市外資股的規定》). These regulations principally govern the issue, subscription, trading and declaration of dividends and other distributions of domestic listed foreign shares and disclosure of information of joint stock limited companies having domestic listed foreign shares.

The Securities Law of the People's Republic of China (PRC Securities Law) was promulgated by the Standing Committee of the NPC on December 29, 1998 and took effect on July 1, 1999, and revised in August 2004, October 2005, June 2013, August 2014 and December 2019, respectively. The PRC Securities Law is the first national securities law in China, and the regulatory matters include the issuance and trading of securities, the acquisition of listed companies, information disclosure, obligations and responsibilities of stock exchanges, securities companies and securities regulatory authorities, etc. The PRC Securities Law comprehensively regulates activities in the PRC securities market.

According to the PRC Securities Law, domestic enterprises issuing securities overseas directly or indirectly or listing and trading their securities overseas shall comply with the relevant provisions of the State Council. At present, the issuance and trading of shares (including H shares) issued overseas is mainly regulated by rules and regulations issued by the State Council and the CSRC.

APPENDIX IV

SUMMARY OF PRINCIPAL LEGAL AND REGULATORY PROVISIONS

ARBITRATION AND ENFORCEMENT OF ARBITRAL AWARDS

Arbitration Law of the People's Republic of China, or the PRC Arbitration Law was promulgated by the Standing Committee of NPC on August 31, 1994, which came into effect on September 1, 1995, and was amended in August 2009 and September 2017. The PRC Arbitration Law provides that an arbitration committee may, before the promulgation of arbitration regulations by the PRC Arbitration Association, formulate interim arbitration rules in accordance with the PRC Arbitration Law and the PRC Civil Procedure Law. Where the parties have agreed to settle disputes by means of arbitration, a people's court will refuse to handle a legal proceeding initiated by one of the parties at such people's court, unless the arbitration agreement is invalid.

According to the Mandatory Provisions, if any disputes or claims in relation to the company's business, with respect to any rights or obligations under the articles of association, the Company Law and other relevant laws and administrative regulations, arise between holders of overseas listed foreign shares and the company, between holders of overseas listed foreign shares and the company's directors, supervisors, managers or other senior management personnel, or between holders of overseas listed foreign shares and holders of domestic shares, the parties concerned shall submit such disputes or claims to arbitration. Disputes with respect to the definition of shareholders and disputes concerning the register of shareholders need not to be resolved by arbitration.

When the aforementioned disputes or claims are submitted to arbitration, such disputes or claims shall be submitted in their entirety, and all persons (being the company, the company's shareholders, directors, supervisors, managers or other senior management personnel) that have a cause of action based on the same grounds or the persons whose participation is necessary for the resolution of such disputes or claims, shall comply with the arbitration.

The applicant for arbitration may choose to be arbitrated either by the China International Economic and Trade Arbitration Commission in accordance with its arbitration rules or the Hong Kong International Arbitration Centre in accordance with its securities arbitration rules. Once the applicant for arbitration submits a dispute or claim to arbitration, the other party must carry out the arbitration at the arbitration institution selected by the applicant. If the arbitration applicant opts for arbitration by the Hong Kong International Arbitration Centre, either party may request arbitration to be conducted in Shenzhen in accordance with the securities arbitration rules of the Hong Kong International Arbitration Centre.

Under the PRC Arbitration Law and PRC Civil Procedure Law, an arbitral award shall be final and binding on the parties involved in the arbitration. If one party fails to implement the award made by an arbitration institution established according to law, the other party may apply to the people's court having jurisdiction for enforcement.

APPENDIX IV

**SUMMARY OF PRINCIPAL LEGAL AND
REGULATORY PROVISIONS**

If the respondent puts forward evidence to prove that the arbitral award is under any of the following circumstances, the award shall not be enforced upon examination and verification by an arbitration tribunal of the people's court:

- (I) the parties have no arbitration clause in their contract, nor have subsequently reached a written agreement on arbitration;
- (II) the matter to be ruled does not fall within the scope of the arbitration agreement or the arbitration institution has no right to arbitrate;
- (III) the composition of the arbitration tribunal or the arbitration procedure violates the legal procedure;
- (IV) the evidence on which the award is based is forged;
- (V) the other party conceals evidence sufficient to influence the impartial award from the arbitration institution;
- (VI) the arbitrators have committed acts of embezzlement, bribery, favoritism and malpractices, or perverting the law in arbitrating the case.

If the people's court determines that the enforcement of the award violates the public interest, the award shall not be enforced.

Where a party to a legally effective arbitral award made by a foreign-related arbitration institution of the People's Republic of China requests enforcement of the award, and if the other party or his property is outside the territory of the People's Republic of China, the party shall directly apply to a foreign court with jurisdiction for recognition and enforcement. Where an award made by a foreign arbitration institution needs to be recognized and executed by the people's court of the People's Republic of China, the party shall directly apply to the intermediate people's court at the place where the person subject to enforcement is domiciled or where his property is located, and the people's courts shall act in accordance with the international treaties concluded or acceded to by the People's Republic of China, or in accordance with the principle of reciprocity.

On December 2, 1986, the Standing Committee of the NPC promulgated the decision on accession to the Convention on the Recognition and Enforcement of Foreign Arbitral Awards (New York Convention) (《承認及執行外國仲裁裁決公約》(《紐約公約》)). The New York Convention provides that all arbitral awards made by a member country of the New York Convention shall be subject to recognition and enforcement by all other member countries of the New York Convention, but in certain circumstances, member countries have the right to refuse enforcement, including recognizing or enforcing the arbitral award is contrary to the public policies of the country.

APPENDIX IV

SUMMARY OF PRINCIPAL LEGAL AND REGULATORY PROVISIONS

In the decision on accession to the New York Convention, the Standing Committee of the NPC also stated:

- (I) the PRC will only apply the New York Convention to the recognition and enforcement of arbitral awards made in the territory of another contracting state based on the principle of reciprocity;
- (II) the PRC will only apply the New York Convention to disputes deemed under PRC law to be arising from contractual or noncontractual mercantile legal relations.

The Arrangements on the Mutual Enforcement of Arbitral Awards between the Mainland and the Hong Kong Special Administrative Region (《關於內地與香港特別行政區相互執行仲裁裁決的安排》) were passed at the Judicial Committee meetings of the Supreme People's Court on June 18, 1999, which went into effect on February 1, 2000. Under the arrangement, if a party fails to perform the arbitral award rendered in the Chinese Mainland or the Hong Kong Special Administrative Region, the other party may apply for enforcement to the relevant court in the place where the respondent is domiciled or where the property is located.

REGULATIONS ON OVERSEAS INVESTMENT

According to the Measures for the Administration of Overseas Investment of Enterprises (《企業境外投資管理辦法》) promulgated by the National Development and Reform Commission on December 26, 2017 and took effect on March 1, 2018, overseas investment refers to the investment activities in which overseas ownership, control, operation and management rights and other relevant rights and interests are obtained by enterprises in China directly or overseas enterprises controlled by it, in the form of investment in assets, rights and interests or provision of financing and guarantee. When making overseas investment, the investor shall go through the overseas investment project approval, filing and other formalities in accordance with relevant conditions of the overseas investment project.

In accordance with the Administrative Measures for Outbound Investment issued by the Ministry of Commerce on September 6, 2014 and took effect on October 6, 2014, overseas investment refers to the behavior conducted by an enterprise legally established within the territory of China that owns a non-financial enterprise abroad or obtains the ownership, control, operation and management right and other rights and interests of an existing non-financial enterprise through new establishment, M&A or other means. The Ministry of Commerce and the provincial competent departments of commerce shall be responsible for the administration and supervision of overseas investment. The Ministry of Commerce and the provincial competent departments of commerce shall carry out administration either by record-filing or approval, depending on different circumstances of outbound investment by enterprises. Outbound investment by enterprises that involves sensitive countries and regions or sensitive industries shall be subject to administration by approval. Outbound investment by enterprises that falls under any other circumstances shall be subject to administration by record-filing.

APPENDIX IV

SUMMARY OF PRINCIPAL LEGAL AND REGULATORY PROVISIONS

In accordance with the Provisions on the Foreign Exchange Administration of the Overseas Direct Investment of Domestic Institutions promulgated by the State Administration of Foreign Exchange on July 13, 2009 and took effect on August 1, 2009, overseas direct investment means that a domestic institution, approved by the competent overseas direct investment department, establishes enterprises or obtains ownership, control or management rights and other rights and interests of existing enterprises or projects overseas by means of establishment (sole proprietorship, joint venture or cooperation), M&A or equity participation. The State Administration of Foreign Exchange implements the foreign exchange registration and filing system for the overseas direct investment of domestic institutions and the assets and relevant rights and interests thereof.

SUMMARY OF MATERIAL DIFFERENCES BETWEEN HONG KONG AND PRC COMPANY LAW

The Hong Kong laws applicable to a company incorporated in Hong Kong are the Companies Ordinance and the Companies (Winding Up and Miscellaneous Provisions) Ordinance and are supplemented by common law and the rules of equity that are applicable to Hong Kong. As a joint stock limited company established in the PRC that is seeking a [REDACTED] of shares on the Hong Kong Stock Exchange, the Company is governed by the PRC Company Law and all other rules and regulations promulgated pursuant to the PRC Company Law.

Set out below is a summary of certain material differences between Hong Kong Company Law applicable to a company incorporated in Hong Kong and the PRC Company Law applicable to a joint stock limited company incorporated under the PRC Company Law. This summary is, however, not intended to be an exhaustive comparison.

Incorporation of Corporate

Under Hong Kong company law, a company with share capital, shall be incorporated by the Registrar of Companies in Hong Kong and the company will acquire an independent corporate existence upon its incorporation. A company may be incorporated as a public company or a private company. Pursuant to the Companies Ordinance, the articles of association of a private company incorporated in Hong Kong shall contain provisions that restrict a member's right to transfer shares. A public company's articles of association do not contain such provisions.

Under the PRC Company Law, a joint stock limited company may be incorporated by promotion or subscription. The amended PRC Company Law which came into effect on October 26, 2018 has no provision on the minimum registered capital of joint stock companies, except that laws, administrative regulations and State Council decisions have separate provisions on paid-in registered capital and the minimum registered capital of joint stock, in which case the company should follow such provisions.

APPENDIX IV

SUMMARY OF PRINCIPAL LEGAL AND REGULATORY PROVISIONS

Share Capital

Under Hong Kong law, the directors of a Hong Kong company may, with the prior approval of the shareholders if required, issue new shares of the company. The PRC Company Law provides that any increase in our registered capital must be approved by our shareholders' general meeting and the relevant PRC governmental and regulatory authorities. There are no such minimum capital requirements on a Hong Kong company under Hong Kong law.

Under the PRC Securities Law, a company which is approved by the relevant securities regulatory authority to list its shares on a stock exchange must have a total share capital of not less than RMB30 million. There is no such restriction on companies incorporated in Hong Kong under Hong Kong law.

Under the PRC Company Law, the shares may be subscribed for in the form of money or non-monetary assets (other than assets not entitled to be used as capital contributions under relevant laws and administrative regulations). For non-monetary assets to be used as capital contributions, appraisals and transfer procedures of property rights must be carried out to ensure no over-valuation or under-valuation of the assets. There is no such restriction on a Hong Kong company under Hong Kong law.

Restrictions on Shareholding and Transfer of Shares

Under PRC law, our Domestic Shares, which are denominated and subscribed for in Renminbi, may only be subscribed for and traded by the government or government authorized departments, PRC legal persons, natural persons, qualified foreign institutional investors, or eligible foreign strategic investors. Overseas listed shares, which are denominated in Renminbi and subscribed for in a foreign currency other than Renminbi, may only be subscribed for, and traded by investors from Hong Kong, Macau or Taiwan or any country and territory outside the PRC, or qualified domestic institutional investors. However, qualified institutional investors and individual investors may trade Southbound Hong Kong trading Link and Northbound Shanghai trading Link (or the Northbound Shenzhen trading Link) shares via participating in Shanghai-Hong Kong Stock Connect and Shenzhen-Hong Kong Stock Connect.

Under the PRC Company Law, a promoter of a joint stock limited company is not allowed to transfer the shares it holds for a period of one year after the date of establishment of the company. Shares in issue prior to the public offering cannot be transferred within one year from the listing date of the shares on a stock exchange. Shares in a joint stock limited company held by its directors, supervisors and senior management transferred each year during their term of office shall not exceed 25% of the total shares they held in the company, and the shares they held in the company cannot be transferred within one year from the listing date of the shares, and also cannot be transferred within half a year after such person has left office. The articles of association may set other restrictive requirements on the transfer of the company's shares

APPENDIX IV

SUMMARY OF PRINCIPAL LEGAL AND REGULATORY PROVISIONS

held by its directors, supervisors and senior management. There are no such restrictions on shareholdings and transfers of shares under Hong Kong law apart from six-month lockup on the company's issue of shares and the 12-month lockup on controlling shareholders' disposal of shares.

Financial Assistance for Acquisition of Shares

The PRC Company Law does not prohibit or restrict a joint stock limited company or its subsidiaries from providing financial assistance for the purpose of an acquisition of its own or its holding company's shares. However, the Mandatory Provisions contain special restrictions provisions on a company and its subsidiaries on providing aforesaid financial assistance similar to those under the Hong Kong Company Law.

Variation of Class Rights

The PRC Company Law has no special provision relating to variation of class rights. However, the PRC Company Law states that the State Council can promulgate separate regulations relating to other kinds of shares. The Mandatory Provisions contain elaborate provisions relating to the circumstances which are deemed to be variations of class rights and the approval procedure required to be followed in respect thereof. These provisions have been incorporated in the Articles of Association.

Under the Companies Ordinance, no rights attached to any class of shares can be varied except (i) with the approval of a special resolution of the holders of the relevant class at a separate meeting, (ii) with the consent in writing of the holders representing at least 75% of the total voting rights of holders of the relevant class of shares, or (iii) if there are provisions in the articles of association relating to the variation of those rights, then in accordance with those provisions.

Directors, Senior Management and Supervisors

The PRC Company Law, unlike Hong Kong Company Law, does not contain any requirements relating to the declaration of directors' interests in material contracts, restrictions on companies providing certain benefits to directors and guarantees in respect of directors' liability and prohibitions against compensation for loss of office without shareholders' approval. The Mandatory Provisions, however, contain certain restrictions on interested contracts and specify the circumstances under which a director may receive compensation for loss of office.

APPENDIX IV

SUMMARY OF PRINCIPAL LEGAL AND REGULATORY PROVISIONS

Supervisory Board

Under the PRC Company Law, a joint stock limited company's directors and members of the senior management are subject to the supervision of supervisory board. There is no mandatory requirement for the establishment of supervisory board for a company incorporated in Hong Kong. The Mandatory Provisions provide that each supervisor owes a duty, in the exercise of his powers, to act in good faith and honestly in what he considers to be in the best interests of the company and to exercise the care, diligence and skill that a reasonably prudent person would exercise in comparable circumstances.

Derivative Action by Minority Shareholders

According to Hong Kong law, as permitted by court, shareholders may initiate a derivative action on behalf of the company against directors who have any misconduct to the company if the directors control a majority of votes at a general meeting, thereby effectively preventing a company from suing the directors in breach of their duties in its own name.

The PRC Company Law provides shareholders of a joint stock limited company with the right so that in the event where the directors and senior management violate their obligations and cause damages to a company, the shareholders individually or jointly holding more than

1% of the shares in the company for more than 180 consecutive days may request in writing the supervisory board to initiate proceedings in the people's court. In the event that the supervisory board violates their obligations and cause damages to company, the above said shareholders may send written request to the board of directors to initiate proceedings in the people's court. Upon receipt of aforesaid written request from the shareholders, if the supervisory board or the board of directors refuses to initiate such proceedings, or has not initiated proceedings within 30 days from the date of receipt of the request, or if under urgent situations, failure of initiating immediate proceeding may cause irremediable damages to the company, the above said shareholders shall, for the benefit of the company's interests, have the right to initiate proceedings directly to the people's court in their own name.

The Mandatory Provisions also provide further remedies against the directors, supervisors and senior management who breach their duties to the company. In addition, as a condition to the listing of shares on the Hong Kong Stock Exchange, each director and supervisor of a joint stock limited company is required to give an undertaking in favor of the company acting as agent for the shareholders. This allows minority shareholders to take action against directors and supervisors of the company in default.

APPENDIX IV**SUMMARY OF PRINCIPAL LEGAL AND REGULATORY PROVISIONS**

Protection of Minorities

Under Hong Kong law, a shareholder who complains that the business of a company incorporated in Hong Kong are conducted in a manner unfairly prejudicial to his interests may petition to the Court to make an appropriate order to give relief to the unfairly prejudicial conduct. Alternatively, pursuant to the Companies (Winding Up and Miscellaneous Provisions) Ordinance, a shareholder may seek to wind up the company on the just and equitable ground. In addition, on the application of a specified number of members, the Financial Secretary may appoint inspectors who are given extensive statutory powers to investigate the affairs of a company incorporated or registered in Hong Kong.

According to the PRC Company Law, in the event that the company encounters substantial difficulties in its operation and management and its continuance shall cause a significant loss to the interest of its shareholders, and where this cannot be resolved through other means, the shareholders who hold more than 10% of the total shareholders' voting rights of the company may present a petition to the People's Court for the dissolution of the company. The Mandatory Provisions, however, contains provisions that a controlling shareholder may not exercise its voting rights in a prejudicial manner to the interests of the entire or part of shareholders of a company to relieve a director or supervisor of his duty to act honestly in the best interests of the company or to approve the expropriation by a director or supervisor of the company's assets or the individual rights of other shareholders.

Notice of Shareholders' General Meetings

Under the PRC Company Law, notice of a shareholders' annual general meeting and an extraordinary shareholders meeting must be given to shareholders at least 20 days and 15 days before the meeting, respectively.

For a company incorporated in Hong Kong, the minimum period of notice is 14 days in the case of an annual general meeting. Further, where a meeting involves consideration of a resolution requiring special notice, the company must also give its shareholders notice of the resolution at least 14 days before the meeting. The notice period for the annual shareholders' general meeting is 21 days.

APPENDIX IV

SUMMARY OF PRINCIPAL LEGAL AND REGULATORY PROVISIONS

Quorum for Shareholders' General Meetings

Under the Companies Ordinance, the quorum for a general meeting must be at least two members unless the articles of association of the company otherwise provided. For companies with only one shareholder, the quorum must be one shareholder. The PRC Company Law does not specify the quorum for a shareholders' general meeting.

Voting

Under the Companies Ordinance, an ordinary resolution is passed by a simple majority of affirmative votes cast by shareholders present in person, or by proxy, at a general meeting, and a special resolution is passed by not less than three-fourths of affirmative votes cast by shareholders present in person, or by proxy, at a general meeting.

Under the PRC Company Law, the passing of any resolution requires more than one-half of the affirmative votes held by our shareholders present at a shareholders' meeting except in cases such as proposed amendments to our articles of association, increase or decrease of registered capital, merger, division, dissolution or transformation, which require two-thirds of the affirmative votes cast by shareholders present at a shareholders' general meeting.

Financial Disclosure

Under the PRC Company Law, a joint stock limited company is required to make available at the company for inspection by shareholders its financial report 20 days before its shareholders' annual general meeting. In addition, a joint stock limited company of which the shares are publicly issued must publish its financial report. The Companies Ordinance requires a company incorporated in Hong Kong to send to every shareholder a copy of its financial statements, auditors' report and directors' report, which are to be presented before the company's annual general meeting, not less than 21 days before such meeting. A joint stock limited company is required under the PRC law to prepare its financial statements in accordance with the PRC GAAP. In addition, pursuant to the Mandatory Provisions, a company must, in addition to preparing financial statements according to the PRC GAAP, have its financial statements prepared and audited in accordance with international accounting standards or the accounting standards of the oversea place where the shares are listed and its financial statements must also contain a statement of the financial effect of the material differences (if any) from the financial statements prepared in accordance with the PRC GAAP. The lower of the after-tax profits of a specific fiscal year stated in the statements prepared based on the above-mentioned principles shall prevail in the allocation of such profits. The company shall publish its financial reports twice in each accounting year. An interim financial report shall be published within 60 days after the end of the first six months of each accounting year, while an annual financial report shall be published within 120 days after the end of each accounting year.

APPENDIX IV

SUMMARY OF PRINCIPAL LEGAL AND REGULATORY PROVISIONS

The Special Regulations require that there should not be any contradiction between the information disclosed within and outside the PRC and that, to the extent that there are differences in the information disclosed in accordance with the relevant PRC and overseas laws, regulations and requirements of the relevant stock exchanges, such differences should also be disclosed simultaneously.

Information on Directors and Shareholders

The PRC Company Law gives shareholders the right to inspect the company's articles of association, minutes of the shareholders' general meetings, share register, counterfoil of company debentures, resolutions of board meetings, resolutions of the Supervisory Committee and financial and accounting reports, which is similar to the shareholders' rights of Hong Kong companies under Hong Kong law.

Receiving Agent

Under the PRC Company Law and Hong Kong law, dividends once declared are debts payable to shareholders. The limitation period for debt recovery action under Hong Kong law is six years, while under the PRC laws this limitation period is three years. The Mandatory Provisions require the relevant company to appoint a trust company registered under the Hong Kong Trustee Ordinance (Chapter 29 of the Laws of Hong Kong) as a receiving agent to receive on behalf of holders of shares dividends declared and all other monies owed by the company in respect of its shares.

Corporate Reorganization

Corporate reorganization involving a company incorporated in Hong Kong may be effected in a number of ways, such as a transfer of the whole or part of the business or property of the company in the course of voluntary winding up to another company pursuant to Section 237 of the Companies (Winding Up and Miscellaneous Provisions) Ordinance or a compromise or arrangement between the company and its creditors or between the company and its shareholders under Section 237 and Division 2 of Part 13 of the Companies Ordinance, which requires the sanction of the court. In addition, subject to the shareholders' approval, an intra-group wholly-owned subsidiary company may also be amalgamated horizontally or vertically under the Companies Ordinance.

Under PRC law, merger, division, dissolution or change the form of a joint stock limited company has to be approved by shareholders in general meeting.

APPENDIX IV

SUMMARY OF PRINCIPAL LEGAL AND REGULATORY PROVISIONS

Dispute Arbitration

In Hong Kong, disputes between shareholders on the one hand, and a company incorporated in Hong Kong or its directors on the other hand, may be resolved through legal proceedings in the courts. The Mandatory Provisions provide that such disputes should be submitted to arbitration at either the HKIAC or the CIETAC, at the claimant's choice.

Statutory Reserve Fund Withdrawal

Under the PRC Company Law, when a joint stock limited company allocating the after-tax profits of the current year, the Company shall allocate (10) ten percent of its profit to the statutory common reserve fund. There are no corresponding provisions under Hong Kong law.

Remedies of the Company

Under the PRC Company Law, if a director, supervisor or senior management in carrying out his duties infringes any law, administrative regulation or the articles of association of a company, which results in damage to the company, that director, supervisor or senior management should be responsible to the company for such damages. In addition, the Listing Rules require listed companies' articles of association to provide for remedies of the company similar to those available under Hong Kong law (including rescission of the relevant contract and recovery of profits from a director, supervisor or senior management).

Dividends

The company has the power in certain circumstances to withhold, and pay to the relevant tax authorities, any tax payable under PRC law on any dividends or other distributions payable to a shareholder. Under Hong Kong law, the limitation period for an action to recover a debt (including the recovery of dividends) is six years, whereas under PRC laws, the relevant limitation period is three years. The company must not exercise its powers to forfeit any unclaimed dividend in respect of shares until after the expiry of the applicable limitation period.

Fiduciary Duties

In Hong Kong, directors owe fiduciary duties to the company, including the duty not to act in conflict with the company's interests. Furthermore, the Companies Ordinance has codified the directors' statutory duty of care.

Under the PRC Company Law, directors, supervisors and senior management should be loyal and diligent. Under the Mandatory Provisions, directors, supervisors and senior management are not permitted, without the approval of the shareholders' general meeting, to engage in any activities which compete with or damage the interests of their company.

APPENDIX IV

**SUMMARY OF PRINCIPAL LEGAL AND
REGULATORY PROVISIONS**

Closure of Register of Shareholders

The Companies Ordinance requires that the register of shareholders of a company must not generally be closed for the registration of transfers of shares for more than 30 days (extendable to 60 days under certain circumstances) in a year, whereas, as required by the PRC Company Law and the Mandatory Provisions, share transfers shall not be registered within 30 days before the date of a shareholders' general meeting or within five days before the base date set for the purpose of distribution of dividends.

APPENDIX V

SUMMARY OF ARTICLES OF ASSOCIATION

SUMMARY OF ARTICLES OF ASSOCIATION

SHARES

Shares and Registered Capital

The shares of the Company shall take the form of stock.

The Company shall maintain ordinary shares at all times. Subject to the approval of the Company approval department authorised by the State Council, the Company may set up other kinds of shares as required.

The issuance of shares shall be conducted in a fair and equitable manner. Each share of the same class shall have the same rights. For the same type of shares issued in the same offering, the issue terms and price shall be identical; each share subscribed by any units or individuals shall be paid at the same price.

Subject to the approval by the securities regulatory authority of the State Council, the Company may issue shares to domestic investors and overseas investors. With the plan for issuing overseas-listed foreign shares and domestic shares by the Company approved by the securities regulatory authority of the State Council, the Board of Directors of the Company may arrange for the implementation of such plan by means of separate issuances. The plan of the Company to separately issue overseas-listed foreign shares and domestic shares in accordance with the provisions of the preceding paragraph may be implemented separately within 15 months from the date of approval by the securities regulatory authority of the State Council or within the period prescribed by the relevant applicable regulations. Where the Company issues overseas-listed foreign shares and domestic shares separately within the total number of shares specified in the issuance plan, every such issue shall be fully subscribed for in one time. If it is impossible for the shares to be fully subscribed for at one time for special reasons, the shares may be issued by several times upon approval by the securities regulatory authority of the State Council.

Increase/Decrease and Repurchase of Shares

The Company may approve capital increase based on the needs of operation and development and in accordance with the Articles of Association.

The Company may increase its registered capital by the following methods:

- (I) public offering of shares;
- (II) private offering of shares;
- (III) placement or distribution of new shares to the existing shareholders;
- (IV) converting funds in the capital reserve into share capital; and
- (V) any other method stipulated by laws and administrative regulations and approved by other relevant regulatory authorities.

APPENDIX V

SUMMARY OF ARTICLES OF ASSOCIATION

The Company's increase of capital by issuing new shares shall be conducted in accordance with the procedures provided in the relevant laws and administrative regulations of the state, after being approved according to the Articles of Association.

The Company may reduce its registered capital. The reduction of registered capital shall follow the procedures set forth in the PRC Company Law and other regulations and provisions of the Articles of Association. When reducing its registered capital, the Company must prepare a balance sheet and an inventory of property. Within ten (10) days of the date on which the resolution on reducing registered capital is made, the creditors shall be notified by the Company and a public announcement shall be made in the newspaper within thirty (30) days. The creditors may, within thirty (30) thirty days as of the receipt of the notice or within forty-five (45) days as of the issuance of the public announcement if it fails to receive a notice, require the Company to clear off its debts or to provide corresponding guarantees. The reduced registered capital of the Company may not be less than the statutory minimum.

The Company may, under any of the following circumstances, buy back its issued shares pursuant to the provisions of laws, regulations, normative documents and the Articles of Association:

- (I) reduction of its registered capital;
- (II) merger with other company which holds the shares of the Company;
- (III) shares are used for employee stock ownership plan or share incentive;
- (IV) any shareholder opposes a resolution on the merger or division of the Company adopted at a shareholders' general meeting and requests the Company to purchase his or her shares;
- (V) the shares are to be used to convert corporate bonds issued by the Company that can be converted to shares;
- (VI) it is necessary for the Company to maintain corporate value and shareholders' interests; or
- (VII) any other circumstance permitted by laws and administrative regulations.

Except for the aforesaid circumstances, the Company shall not trade in its shares.

The Company may repurchase its shares by any of the following methods:

- (I) issuance to all the shareholders of a buyback offer on a pro rata basis;
- (II) buyback through open transaction on a stock exchange;
- (III) buyback by agreement outside a stock exchange; or

APPENDIX V

SUMMARY OF ARTICLES OF ASSOCIATION

- (IV) by other means as permitted by the laws, administrative regulations, listing rules of the place where the securities of the Company are listed and the relevant competent authorities.

A prior approval shall be obtained from the shareholders' general meeting in respect of any share repurchase by the Company through an off-market agreement in accordance with the provisions of our Articles of Association. After the shareholders' general meeting has given its prior approval in the same way, the Company may rescind or alter any contracts entered into in the said manner or waive any rights under such contracts. The aforesaid contract to repurchase shares includes, but not limited to, an agreement to become obliged to repurchase or to acquire the right to repurchase shares. The Company shall not assign a contract for repurchasing its shares or any of its rights thereunder. Where the Company has redeemable shares and has the right to repurchase the redeemable shares, purchases not made through the market or by tender shall be limited to a maximum price, and if purchases are made by tender, tenders shall be available to all Shareholders alike.

The Company purchasing its own shares under any of the circumstances set forth in items (I) and (II) above shall be subject to a resolution of the shareholders' general meeting. The Company purchasing its own shares under any of the circumstances set forth in Items (III), (V) and (VI) above may be subject to a resolution of a meeting of the Board of Directors at which more than two-thirds of Directors are present.

The shares repurchased according to the above provisions under the circumstance stipulated in item (I) hereof shall be deregistered within ten days from the date of acquisition of shares; the shares shall be assigned or deregistered within six months if the repurchase of shares is made under the circumstances stipulated in either item (II) or item (IV); and the shares in the Company held in total by the Company after the repurchase of shares under any of the circumstances stipulated in item (III), item (V) or item (VI) shall not exceed 10% of the Company's total outstanding shares, and shall be assigned or deregistered within three years. After the repurchase of shares according to law, the Company shall deregister or transfer the said shares before the deadline specified by the laws and administrative regulations if the shares should be deregistered according to law, and shall have the change of the registered capital registered with the original company registration authority after deregistration of the shares. The aggregate par value of those deregistered shares shall be deducted from the Company's registered capital.

Transfer of shares

Unless otherwise provided by laws, administrative regulations and listing rules of the place where the securities of the Company are listed, the shares of the Company for which full payment is made can be transferred freely without any limitation and are not subject to any lien. Transfer of overseas listed foreign shares listed in Hong Kong shall be registered with the Hong Kong-based share registrar entrusted by the Company.

The Company does not accept its own shares as the collateral of pledge.

APPENDIX V

SUMMARY OF ARTICLES OF ASSOCIATION

Financial Assistance for the Acquisition of the Shares of the Company

The Company or its subsidiaries shall not, at any time and in any manner, provide any financial assistance to purchasers or prospective purchasers of the shares of the Company. The aforesaid purchasers of shares of the Company shall include persons who directly or indirectly assume relevant obligations as a result of purchasing shares of the Company. The Company or its subsidiaries shall not, at any time and in any manner, provide any financial assistance to the above obligators in order to reduce or discharge their obligations.

The acts listed below are not prohibited by the above provisions:

- (I) where the financial assistance given by the Company is genuinely for the benefits of the Company and the main purpose of such financial assistance is not to purchase shares of the Company, or the financial assistance is an incidental part of a general plan of the Company;
- (II) distribution of the Company's properties as dividends pursuant to the law;
- (III) distribution of dividends in the form of shares;
- (IV) reduction of registered capital, buy-back of shares and shareholding structuring etc., in accordance with the Articles of Association;
- (V) provision of a loan by the Company within its business scope and in the ordinary course of its business (provided that it does not lead to a reduction in the net assets of the Company or that if it constitutes a reduction, the financial assistance was paid out of the Company's distributable profits); and
- (VI) provision of money by the Company for an employee stock ownership plan (provided that it does not lead to a reduction in the net assets of the Company or that if it constitutes a reduction, the financial assistance was paid out of the Company's distributable profits).

Shares and Register of Members

The Company's shares shall be in registered form.

Matters to be specified in the Company's shares shall include:

- (I) name of the Company;
- (II) date of incorporation of the Company;
- (III) category of share, par value and number of shares represented;

APPENDIX V

SUMMARY OF ARTICLES OF ASSOCIATION

- (IV) share certificate number;
- (V) other particulars that are required to be specified by the Company Law of the People's Republic of China, the Special Provisions and the stock exchange where the securities of the Company are listed.

The Company may issue overseas listed foreign shares in the form of foreign depository receipts or other derivatives of shares in accordance with the laws of the place where the Company's shares are listed and the practice of securities registration and deposit.

The Company shall keep a register of members, in which the following particulars shall be recorded:

- (I) the name, address (domicile), occupation or nature of each shareholder;
- (II) the category and quantity of shares held by each shareholder;
- (III) the amount paid or payable for the shares held by each shareholder;
- (IV) the share certificate numbers of the shares held by each shareholder;
- (V) the date on which each shareholder is registered as a shareholder; and
- (VI) the date on which each shareholder ceases to be a shareholder.

The Company may, in accordance with any understanding or agreements between the securities regulatory authority of the State Council and overseas securities regulatory organisations, keep its original register of members for the holders of overseas listed foreign shares overseas and appoint overseas agent(s) to manage such register. The original register of members for the holders of overseas listed foreign shares listed in Hong Kong shall be maintained in Hong Kong. A duplicate register of members for the holders of overseas listed foreign shares shall be maintained by the Company at the Company's domicile. The appointed overseas agent shall ensure consistency between the original and the duplicate register of members for the holders of overseas listed foreign shares at all times. If there is any inconsistency between the original and the duplicate register of members for the holders of overseas listed foreign shares, the original shall prevail.

Change of the register of members arising from share transfer shall not be registered within 30 days before convening of a shareholders' general meeting or within five days prior to the benchmark date on which the Company decides to distribute dividends.

Any person who disagrees with the register of members and requests that his or her name be registered in the register of members or that his or her name be removed from the register of members may apply to the court with jurisdiction to correct the register of members.

APPENDIX V

SUMMARY OF ARTICLES OF ASSOCIATION

Any shareholder whose name is entered on the register of members or any person who requires his or her name be entered on the register of members may apply to the Company for a new share certificate to be re-issued in respect of relevant share if the share certificate is lost.

SHAREHOLDERS AND SHAREHOLDERS' GENERAL MEETING

Shareholders

The Company's shareholders are persons who lawfully hold shares of the Company and whose names are entered in the register of members. Shareholders enjoy rights and fulfil obligations according to the class and number of their shares. Holders of the same class of shares shall enjoy the same rights and bear the same obligations. Class shareholders of the Company shall rank *pari passu* over any distribution by way of dividend or any other forms of distribution.

The shareholders of ordinary shares of the Company shall be entitled to the following rights:

- (I) to receive dividends and other kinds of benefit distributions as determined by the number of shares held by them;
- (II) to require, convene, chair, attend or appoint a proxy to attend a shareholders' general meeting pursuant to the law and exercise the corresponding voting rights;
- (III) to supervise and manage the business operations of the Bank, and to make suggestions and enquiries;
- (IV) to transfer, bestow or pledge shares held by them in accordance with the laws, administrative regulations and the Articles of Association;
- (V) to obtain related information in accordance with provisions of the Articles of Association, including:
 1. obtain the copies of the Article of Association after paying relevant costs;
 2. have the right to inspect and photocopy, after paying a reasonable fee, the following documents:
 - (1) copies of the register of members;
 - (2) personal information of the directors, supervisors, general manager and other senior management personnel of the Company, including:
 - (a) current and previous names and aliases;

APPENDIX V

SUMMARY OF ARTICLES OF ASSOCIATION

- (b) principal address (place of domicile);
 - (c) nationality;
 - (d) full-time and all other part-time occupations and titles;
 - (e) identification document and its number.
- (3) a report showing the state of the issued share capital of the Company;
 - (4) reports showing the total par value, quantity, maximum and minimum prices paid in respect of each class of shares repurchased by the Company since the end of the last fiscal year and the aggregate amount of cost incurred by the Company for this purpose (by domestic shares and foreign shares (and H shares, if applicable));
 - (5) minutes of the shareholders' general meetings (only for Shareholders to inspect) and copies of special resolutions of the Company, copies of resolutions of meetings of the Board and the Supervisory Committee;
 - (6) the latest audited financial statements of the Company, and the reports of the Board, the accounting firm and the Supervisory Committee;
 - (7) copy of the latest issue of annual inspection report already submitted to the Administration for Industry and Commerce of PRC or other competent authorities for filing;

The Company shall keep documents related to Items (1)-(7) except (2) above and any other applicable documents at the Company's Hong Kong domicile according to Hong Kong Listing Rules for public and Shareholders to inspect free of charge (except for minutes of shareholders' general meetings which are only for reference of shareholders). The shareholders of the Company may also inspect the resolutions of meetings of the Board and resolutions of meetings of the Supervisory Committee. If any shareholder requests to inspect the aforesaid relevant information or asks for relevant data, the said shareholder shall provide the Company with written documents bearing evidence of the class and number of shares held by the said shareholder in the Company, and the Company will provide the said information or data as required by the said shareholder upon authentication of the identity of the said shareholder.

- (VI) upon termination or liquidation of the Company, participating in the distribution of the Company's residual assets based on their shareholding;
- (VII) a shareholder who objects to the resolution on merger or division of the Company passed by a shareholders' general meeting may request the Company to acquire his/her/its shares;

APPENDIX V

SUMMARY OF ARTICLES OF ASSOCIATION

(VIII) any other rights stipulated by laws, administrative regulations, departmental rules, listing rules of the place where the securities of the Company are listed and the Articles of Association.

Where the contents of a resolution of shareholders' general meeting or the Board of Directors violate any law or administrative regulation, shareholders are entitled to petition to the people's court to declare the resolution invalid.

Where the convening procedures or voting method of a shareholders' general meeting or a Board meeting violate any laws, administrative regulations or the Articles of Association, or the contents of a resolution violate the Articles of Association, a shareholder shall have the right to apply to the people's court for revocation within 60 days from passing of such resolution.

Where the directors or senior management personnel violate the provisions of laws, administrative regulations or the Articles of Association during the performance of their duties, causing losses to the Company, the shareholders severally or jointly holding 1% or more of the Company's shares for a period of 180 consecutive days or longer are entitled to request the Supervisory Committee to file a lawsuit with the people's court in writing; where the Supervisory Committee violates the provisions of laws, administrative regulations or the Articles of Association in the performance of duties, causing losses to the Company, the aforesaid shareholders may request the Board of Directors to file a lawsuit with the people's court in writing.

Upon receipt of shareholders' written request stipulated in the preceding paragraph, if the Supervisory Committee or the Board of Directors refuses to file a lawsuit or does not file a lawsuit within 30 days from receipt of such request, or in the event of emergency where the interest of the Company will suffer irreparable damages if lawsuit is not filed immediately, the shareholders stipulated in the preceding paragraph shall have the right to file a lawsuit directly with the people's court in their own name for the interest of the Company.

If others infringe upon the legitimate rights and interests of the Company, causing losses to the Company, the shareholders individually or jointly holding over 1% of the shares in the Company for more than 180 consecutive days may file a lawsuit with the people's court according to the provisions of the preceding two paragraphs.

Where any director or senior management personnel violates the provisions of laws, administrative regulations or the Articles of Association, damaging interests of shareholders, the shareholders may file a lawsuit with the people's court.

The shareholders of the Company's ordinary shares shall undertake the following obligations:

(I) to observe the Articles of Association;

APPENDIX V

SUMMARY OF ARTICLES OF ASSOCIATION

- (II) to pay capital contribution as per the shares subscribed for and the method of subscription;
- (III) not to make divestment unless in the circumstances stipulated by laws and regulations;
- (IV) any other obligations stipulated by laws, administrative regulations, rules, normative documents, listing rules of the place where the securities of the Company are listed and the Articles of Association.

Shareholders shall not bear any liability for further contribution to share capital other than the conditions agreed to as a subscriber of the relevant shares on subscription.

In addition to the obligations required under the laws, administrative regulations or listing rules of the stock exchange where the securities of the Company are listed, when exercising their rights as a shareholder, Controlling Shareholders shall not, by exercising their voting rights, make decisions on the following issues that are detrimental to the interests of all or some of the shareholders:

- (I) relieving a director or a supervisor of their responsibility to act in good faith and in the best interests of the Company;
- (II) approving a Director or a Supervisor (for his/her own or for the benefit of others) in depriving the Company of its property in any form, including (but not limited to) any opportunities that are favourable to the Company;
- (III) approving a Director or a Supervisor (for his/her own or for the benefit of others) in depriving other Shareholders of their personal interests, including but not limited to any distribution rights and voting rights, unless the deprivation is made pursuant to a Company restructuring submitted to and adopted at the Shareholders' general meeting in accordance with the Articles of Association.

General Rules for the Shareholder's General Meeting

The shareholders' general meeting is the organ of authority of the Company, and shall exercise following functions and powers pursuant to the law:

- (I) to determine the Company's operating principles and investment plans;
- (II) to elect and replace directors and determine the remuneration of relevant directors;
- (III) to elect and replace non-employee representative supervisors and determine the remuneration of relevant supervisors;
- (IV) to review and approve the reports of the Board of Directors;

APPENDIX V

SUMMARY OF ARTICLES OF ASSOCIATION

- (V) to review and approve the reports of the Supervisory Committee;
- (VI) to review and approve the Company's annual financial budgets and final accounts;
- (VII) to review and approve the Company's profit distribution proposals and loss recovery proposals;
- (VIII) to decide on any increase or reduction of the Company's registered capital;
- (IX) to decide on merger, division, dissolution and liquidation of the Company or change of its corporate form;
- (X) to decide on the issuance of bonds or other securities and the listing of the Company;
- (XI) to decide on the engagement, dismissal or discontinuation of the appointment of the accounting firm;
- (XII) to amend the Articles of Association;
- (XIII) to review the proposals raised by the Shareholders severally or jointly representing above three percent of the Company's Shares with voting rights;
- (XIV) to deliberate any other matter to be decided on by the shareholders' general meeting as stipulated by laws, administrative regulations, the listing rules of the place where the securities of the Company are listed or the Articles of Association.

The Shareholders' general meetings shall be divided into annual general meetings and extraordinary general meetings. A shareholders' general meeting shall be convened by the Board of Directors. The annual general meeting shall be held once a year within six months after the previous financial year ends.

An extraordinary general meeting is required to be held by the Board of Directors within two months of the occurrence of any of the following:

- (I) the number of Directors is less than the minimum number required by the Company Law of PRC or less than two-thirds of the number stipulated in the Articles of Association;
- (II) the outstanding losses of the Company amounted to one-third of the Company's total paid-in share capital;
- (III) shareholders individually or in aggregate holding 10% or more of the Company's issued and outstanding shares carrying voting rights request in writing that an extraordinary general meeting is convened;

APPENDIX V

SUMMARY OF ARTICLES OF ASSOCIATION

- (IV) the Board of Directors deems it as necessary or the Supervisory Committee proposes that the meeting be convened;
- (V) any other circumstances stipulated by laws and regulations, listing rules of the place where the securities of the Company are listed and the Articles of Association.

Convening of Shareholders' General Meeting

A shareholders' general meeting shall be convened by the Board of Directors. If the Board is unable to or fails to perform its duty of convening the shareholders' general meeting, the Supervisory Committee shall convene and preside over such meeting in a timely manner; if the Supervisory Committee cannot convene and preside over such meeting, shareholders who individually or jointly hold more than 10% of the Company's shares for more than 90 consecutive days may independently convene and preside over such meeting.

Shareholders requesting the convening of an extraordinary general meeting or a class shareholders' general meeting shall proceed in accordance with the procedures set forth below:

- (I) two or more Shareholders individually or collectively holding more than 10% (inclusive of 10%) of the voting Shares at the proposed meeting can request the Board of Directors to convene an extraordinary general meeting or a class meeting by signing one or several written request(s) with the same content and in the same format, and stating the matters to be considered at the meeting. The Board shall convene such meeting as soon as possible upon receipt of the aforesaid written request. The Shareholders shall calculate the aforesaid number of shareholdings as of the date of the submission of the written requirement.
- (II) If the Board of Directors fails to issue a notice on the convening of meeting within 30 days after receiving the aforesaid written request, the Shareholders who made such request may convene the meeting on their own within four months after the Board of Directors receives the request. The convening procedures shall be the same as the procedures for the convening of shareholders' general meeting by the Board of Directors.

If the Shareholders call and convene a meeting by themselves due to the Board of Directors being unable to convene a meeting in accordance with the aforesaid requirement, the expenses reasonably incurred therefrom shall be borne by the Company and be deducted from the amounts due to the relevant directors as a result of negligence of duty.

The Supervisory Committee is entitled to propose to the Board of Directors to convene an extraordinary general meeting and such proposal shall be made in writing to the Board of Directors. The Board of Directors shall, in accordance with laws, administrative regulations and the Articles of Association, reply in writing on whether or not to agree on the convening of the extraordinary general meeting within 10 days upon the receipt of the proposal.

APPENDIX V

SUMMARY OF ARTICLES OF ASSOCIATION

If the Board of Directors agrees to convene an extraordinary general meeting, it shall serve a notice of such meeting within five days after the resolution is approved by the Board of Directors. Any change to the original proposal setting forth in the notice shall be subject to approval by the Supervisory Committee.

If the Board of Directors does not agree to convene an extraordinary general meeting or fails to give a written reply within 10 days after receipt of the proposal, it shall be deemed to be unable to perform or fail to perform the duty of convening the extraordinary general meeting, and the Supervisory Committee may convene and preside over the meeting by itself.

If the shareholders' general meeting is convened by the Supervisory Committee or shareholders on their own, a written notice shall be issued to the Board of Directors.

Where the Supervisory Committee or the shareholders convene a shareholders' general meeting on their own, the Board of Directors shall cooperate. The Board of Directors shall provide the register of members as of the date of share recording.

Where the Supervisory Committee or the shareholders convene a shareholders' general meeting on their own, the necessary expenses incurred thereof shall be borne by the Company.

Proposal and Notification of Shareholders' General Meeting

When the Company decides to convene a shareholders' general meeting, the Board of Directors, the Supervisory Committee and shareholders severally or jointly holding 3% or more of the shares of the Company shall be entitled to put forward proposals to the Company.

Shareholders individually or collectively holding at least 3% of the Shares of the Company may submit a temporary resolution in writing to the convener 10 days prior to the convening of such meeting. The convener shall serve a supplementary notice of shareholders' general meeting within two days after receipt of the proposals. The shareholders' general meeting shall not vote and adopt a resolution on any proposal that is not listed in the notice of the shareholders' general meeting or that is inconsistent with the Articles of Association.

Voting at Shareholders' General Meetings

Resolutions made at a shareholders' general meeting shall be divided into ordinary resolutions and special resolutions.

Ordinary resolutions of the shareholders' general meeting shall be passed by more than half of the voting rights represented by shareholders (including their proxies) present at the meeting.

Special resolutions shall be approved by above two-thirds of voting rights held by the Shareholders (including their proxies) attending the shareholders' general meeting.

APPENDIX V

SUMMARY OF ARTICLES OF ASSOCIATION

The following matters shall be approved by ordinary resolutions at a shareholders' general meeting:

- (I) work reports of the Board of Directors and the Supervisory Committee;
- (II) the profit distribution proposals and loss recovery proposals formulated by the Board of Directors;
- (III) election and removal of members of the Board of Directors and the supervisors who are not staff representatives, and their remunerations and methods of payment;
- (IV) the annual budget and final accounts, the balance sheet, statements of profits and other financial statements of the Company; and
- (V) all other proposals not resolved by special resolutions as provided for in laws, administrative regulations, listing rules of the place where the securities of the Company are listed or the Articles of Association.

The following matters shall be approved by a special resolution at a shareholders' general meeting:

- (I) increase or reduction in the registered capital, and issuance of any class of shares, warrants or other similar securities by the Company;
- (II) issuance of corporate bonds;
- (III) division, merger, dissolution, liquidation of the Company or change in the form of the Company;
- (IV) amendment to the Articles of Association;
- (V) other matters which are resolved in shareholders' general meeting by ordinary resolution as being material to the Company and required to be passed by special resolution;
- (VI) all other proposals which shall be resolved by special resolutions as provided in laws, administrative regulations, listing rules of the place where the securities of the Company are listed or the Articles of Association.

A shareholder (including his or her proxy) shall vote based on the number of his or her voting shares, with one share representing one vote. No voting rights shall attach to the shares held by the Company, and such shares shall not be counted among the total number of voting shares present at a shareholders' general meeting.

APPENDIX V

SUMMARY OF ARTICLES OF ASSOCIATION

Special Procedures for Voting by Class Shareholders

Shareholders who hold different classes of Shares shall be class shareholders.

If the Company intends to change or abrogate the rights of class shareholders, it may do so only after such change or abrogation has been approved by way of a special resolution of the shareholders' general meeting and by a separate shareholders' general meeting convened by the affected class shareholders in accordance with the Articles of Association.

The rights of a class shareholder shall be deemed to be changed or abolished under any of the following circumstances:

- (I) an increase or decrease in the number of shares of such class or an increase or decrease in the number of shares of a class having voting rights, distribution rights or other privileges equal or superior to those of the shares of such class;
- (II) a change of all or part of the shares of such class into shares of another class, a conversion of all or part of the shares of another class into shares of such class or the grant of the right to such change;
- (III) a removal or reduction of rights to accrued dividends or cumulative dividends attached to shares of such class;
- (IV) a reduction or removal of a dividend preference or property distribution preference during liquidation of the Company attached to shares of such class;
- (V) an addition, removal or reduction of share conversion rights, options, voting rights, transfer rights, pre-emptive rights or rights to acquire securities of the Company attached to shares of such class;
- (VI) a removal or reduction of rights to receive amounts payable by the Company in a specified currency attached to shares of such class;
- (VII) a creation of a new class of shares with voting rights, distribution rights or other privileges equal or superior to those of the shares of such class;
- (VIII) an imposition of restrictions or additional restrictions on the transfer or ownership of shares of such class;
- (IX) an issuance of rights to subscribe for or convert into shares of such class or another class;
- (X) an increase in the rights and privileges of shares of another class;

APPENDIX V

SUMMARY OF ARTICLES OF ASSOCIATION

- (XI) a restructuring plan of the Company which will cause shareholders of different categories to bear liability to different extents during the restructuring; and
- (XII) an amendment to or nullification of the provisions in this chapter.

Shareholders of the affected class, whether or not having the right to vote at shareholders' general meeting, shall have the right to vote at the class shareholders' meeting in respect of matters referred to in Items (II) to (VIII) or (XI) to (XII) above, provided that interested class shareholders shall not have the right to vote at the class shareholders' meeting.

A resolution of the class shareholders' meeting shall be adopted by above two-thirds of the voting shares represented by class shareholders present at the meeting.

The special procedures for voting by a class shareholder shall not apply in the following circumstances:

- (I) upon the approval by way of a special resolution on the shareholders' general meeting, the Company independently or simultaneously issues Domestic Shares and/or overseas listed foreign shares every 12 months, and the amount of Domestic Shares and overseas listed foreign shares that are intended to be issued is more than 20% of the issued and outstanding shares of their respective class;
- (II) the Company's plan on issuing Domestic Shares and overseas listed foreign shares at the time of its incorporation, which is completed within 15 months upon the date of approval from the securities regulatory authorities under the State Council;
- (III) where the transfer of the shares held by the holders of domestic shares of the Company to foreign investors or conversion of such shares into overseas listed foreign shares and listing on overseas stock exchange are approved by the securities regulatory authorities under the State Council.

DIRECTORS AND BOARD OF DIRECTORS

Directors

Directors shall be elected or replaced by the shareholders' general meeting and serve a term of office of three years. At the expiry of their terms, Directors may continue to serve as such if re-elected. Directors are not required to hold any shares of the Company.

The director may resign before his or her term of office expires. The director who resigns shall submit to the Board of Directors a written resignation. A director shall continue to perform his/her duties as a director in accordance with the laws, administrative regulations and the Articles of Association until a duly re-elected director takes office, if re-election is not conducted in a timely manner upon the expiry of his/her term of office or if the resignation of directors during the term of office results in the number of directors being less than the quorum.

APPENDIX V

SUMMARY OF ARTICLES OF ASSOCIATION

If a Director fails to attend in person or entrust other directors to attend the Board meetings for two consecutive times, he/she shall be deemed to be unable to perform his/her duties, and the Board of Directors may propose to the shareholders' general meeting to replace such Director.

Independent Non-executive Director

The independent non-executive Director refers to the Director who does not hold any other position in the Company other than Director, member or chairman of the special committees of the Board of Directors, and has no relationship with the Company and substantial shareholders that may affect his independent and objective judgment. The number of the independent non-executive Directors shall represent at least one third of the total members of the Board and not less than three members. At least one of the independent non-executive Directors of the Company shall have appropriate professional qualification or accounting or relevant financial management expertise, and at least one of them shall normally reside in Hong Kong.

The term of office of the independent non-executive Director is the same as that of other directors of the Company. Upon expiration of his/her term, the independent non-executive Director can be re-elected. An independent non-executive Director shall have the qualification and independence to hold office as stipulated by laws and regulations and the listing rules of the place where the Company's shares are listed.

The Board of Directors

The Company has a Board of Directors, which consists of 10 Directors, with a chairman, including four independent non-executive Directors with at least one accounting professional.

The Board of Directors shall be responsible to the shareholders' general meetings and exercise the following functions and powers:

- (I) to convene Shareholders' general meeting and report on its work to the Shareholders' general meetings;
- (II) to implement the resolutions of the Shareholders' general meeting;
- (III) to decide on the business plans and investment plans of the Company;
- (IV) to formulate proposal for the Company's annual financial budgets and final accounts;
- (V) to formulate the Company's profit distribution proposals and loss recovery proposals;

APPENDIX V

SUMMARY OF ARTICLES OF ASSOCIATION

- (VI) to formulate proposals for the increase or reduction of the Company's registered capital and the issue of corporate bonds;
- (VII) to formulate proposals for the merger, division or dissolution of the Company or change of corporate form;
- (VIII) to decide on the internal management setup of the Company;
- (IX) to appoint or dismiss the general manager of the Company; to appoint or dismiss senior vice general manager, vice general manager, chief financial officer and other senior management personnel of the Company based on the nominations of the general manager, and to determine their emoluments;
- (X) to formulate the Company's basic management system;
- (XI) to formulate plans for amendment of the Articles of Association;
- (XII) other duties and powers provided in laws and regulations, listing rules in the place where security of the Company are listed and granted by the shareholders' general meeting, and specified in the Articles of Association.

Resolutions by the Board of Directors on matters referred to in the preceding paragraph, except for items (VI), (VII) and (XI), may be passed by the affirmative vote of more than half of the Directors. The Board of Directors shall perform its duties in accordance with national laws, administrative regulations, the listing rules of the place where the securities of the Company are listed, the Articles of Association and resolutions approved by the shareholders' general meeting.

For the disposal of any fixed assets by the Board of Directors, if the aggregate of the expected value of the fixed assets proposed to be disposed of and the value of the fixed assets which had been disposed of within four months preceding such proposal for disposal exceeds 33% of the fixed assets value shown in the most recent balance sheet reviewed at a shareholders' general meeting, the Board of Directors shall not dispose of or approve of the disposal of such fixed assets without the approval of the shareholders' general meeting.

The chairman of the Board of Directors shall exercise the following powers and functions:

- (I) to preside over general meetings and to convene and preside over Board meetings;
- (II) to check on the implementation of resolutions of the Board of Directors;
- (III) to sign the securities issued by the Company;
- (IV) to exercise other functions and powers granted by the Board of Directors or the listing rules of the place where the securities of the Company are listed.

APPENDIX V

SUMMARY OF ARTICLES OF ASSOCIATION

Where the chairman is incapable of performing or is not performing his/her duties, a director nominated by more than half of the directors shall perform his/her duties.

Board meetings include regular meetings and extraordinary meetings. Board meetings shall be convened at least four times a year and be called for by the chairman. The notice of the regular meeting of the Board of Directors shall be given not less than 14 days in advance, and the notice of the extraordinary meeting shall be given not less than 5 days in advance. With the consent of the Directors of the Company, the time limit of the above notices may be exempted. However, in the event of emergency for which an extraordinary meeting of the Board of Directors needs to be held as soon as possible, the notice may be given by telephone or other oral means at any time, provided that the convener shall give an explanation at the meeting therefor.

Meetings of the Board of Directors shall be held only if more than half of the Directors (including directors in proxy in according with the Articles of Association) attend. Each director shall have one vote. The resolution proposed by the Board of Directors shall be passed by more than half of all directors, unless otherwise stated in the Articles of Association. When the negative votes and the affirmative votes are the same, the chairman has one more vote.

The directors shall attend the Board meeting by themselves. If a director is unable to attend for any reason, he/she may appoint another director to attend the meeting on his/her behalf by a written power of attorney specifying the scope of authorization.

The Board of Directors and any committee thereof shall record the decisions on the matters discussed at the meeting as minutes, and the directors and recorder attending the meeting shall sign the minutes.

Special Committees of the Board of Directors

The Board of Directors may set up special committees such as Audit Committee, Remuneration and Assessment Committee, Nomination Committee and Strategy Committee, and formulate corresponding implementation rules to stipulate the main responsibilities, decision-making procedures and rules of procedures of each special committee. The Board of Directors shall be responsible for amendment and interpretation of the implementation rules of each special committee.

Secretary to the Board

There shall be a secretary of the Board. The secretary of the Board of Directors is a member of senior management of the Company.

APPENDIX V

SUMMARY OF ARTICLES OF ASSOCIATION

The Secretary to the Board of Directors shall be a natural person with the necessary professional knowledge and experience and shall be appointed or dismissed by the Board of Directors. Its principal responsibilities include:

- (I) ensure that the Company has complete organizational documents and records;
- (II) ensure that reports and documents requested by the competent authorities are prepared and submitted by the Company in accordance with the law and be responsible for accepting, organizing and completing related tasks assigned by supervisory authorities;
- (III) ensure that the register of shareholders of the Company is properly established, and ensure that the person that has the right to receive any records and documents from the Company will receive such records and documents timely;
- (IV) be responsible for the information disclosure matters of the Company, and ensure that the information disclosed by the Company is timely, accurate, legal, true and complete; and
- (V) exercise other functions and powers as conferred by the Board, as well as other functions and powers as required by the stock exchanges on which the Company's shares are listed.

Directors or other senior management staff of the Company may concurrently hold the office of the Secretary to the Board. No accountant of an accounting firm engaged by the Company may concurrently hold the office of the Secretary to the Board.

Where a Director concurrently serves as the secretary to the Board, if any act needs to be done separately by a Director and the secretary to the Board, the person concurrently serving as Director and the secretary to the Board shall not take such action in both capacities.

General Manager

The Company shall have one general manager to be appointed or dismissed by the Board of Directors. The Company shall have several deputy general managers to be appointed or dismissed by the Board of Directors. The Board of Directors shall have the right to appoint members of the Board of Directors to serve concurrently as general manager. The term of office of the general manager shall be 3 years and the general manager may be reappointed upon the expiration of his/her term.

The general manager, who is responsible for the Board of Directors, may exercise the following functions and powers:

- (I) to lead the Company's operation and management, to organize the implementation of the resolutions of the Board and to report to the Board;

APPENDIX V

SUMMARY OF ARTICLES OF ASSOCIATION

- (II) to organise the implementation of the Company's annual business plans and investment plans;
- (III) to formulate plans for establishment of internal management organisations of the Company;
- (IV) to draft the Company's basic management system;
- (V) to formulate the basic rules and regulations of the Company;
- (VI) to propose the appointment or dismissal of the Company's vice general manager(s) and the chief financial officer;
- (VII) to appoint or dismiss management personnel (other than those required to be appointed or dismissed by the Board of Directors);
- (VIII) to exercise other duties and powers conferred by the Articles of Association or the Board.

The general manager shall attend the Board meetings, but he/she has no voting rights at the Board meetings if he/she is not a director.

The general manager of the Company shall exercise the functions and powers in accordance with laws, administrative regulations, rules, normative documents, relevant provisions of the securities regulatory authorities of the place(s) where the Shares of the Company are listed and the Articles of Association and performs the obligations of honesty and diligence.

Supervisory Committee

The Company shall establish a Supervisory Committee. The Supervisory Committee shall comprise three supervisors, including one chairman. Each term of office of a supervisor is three years and he may serve consecutive terms if re-elected. The appointment and dismissal of the chairman of the Supervisory Committee shall be passed by the votes of more than two-thirds of the members of the Supervisory Committee.

The Supervisory Committee consists of two representatives of the Shareholders and one employee representative of the Company. Shareholder representatives shall be elected and removed by Shareholders' general meetings, and employee representatives shall be elected and removed democratically by the employees of the Company.

Directors, general manager and other senior management members of the Company may not serve as Supervisors concurrently.

APPENDIX V

SUMMARY OF ARTICLES OF ASSOCIATION

The meetings of the Supervisory Committee consist of regular meetings and extraordinary meetings. Regular meetings of the Supervisory Committee shall be convened at least once each six months and be convened and presided by its chairman. Extraordinary meetings of the supervisory committee can be convened by the supervisors. A Supervisor shall be elected by more than half of all Supervisors to convene and host the meetings of Supervisory Committee when the chairman fails or refuses to perform the duty.

The Supervisory Committee shall be accountable to the shareholders' general meeting and shall exercise the following functions and powers in accordance with the law:

- (I) to review the Company's financial position;
- (II) to supervise the Directors, general manager and other senior management in their performance of their duties of the Company and to propose the removal of Directors and senior management who have violated laws, administrative regulations, listing rules of the place(s) where the Shares of the Company are listed and the Articles of Association or resolutions of general meetings;
- (III) when the acts of a Director, general manager and other senior management are detrimental to the Company's interests, to require him/her to correct such acts;
- (IV) to verify financial information such as financial reports, business reports, profit distribution plans that the Board of Directors intends to submit to the shareholders' general meeting and, if in doubt, a registered accountant or practicing auditor shall be appointed in the name of the Company to assist in reviewing such information;
- (V) to propose the convening of extraordinary Shareholders' general meeting and to convene and preside over Shareholders' general meeting when the Board fails to perform the duty of convening and presiding over Shareholders' general meetings;
- (VI) to make proposals to the shareholders' general meeting;
- (VII) to negotiate with Directors on behalf of the Company or to initiate litigation against Directors, general manager and other senior management members in accordance with the law and the Articles of Association of the Company; and
- (VIII) to exercise other functions and powers stipulated in the Articles of Association.

Supervisors may attend board meetings and make enquiries or proposals in respect of Board resolutions.

APPENDIX V

SUMMARY OF ARTICLES OF ASSOCIATION

The meeting of the Supervisory Committee shall only be held when more than two-thirds of the Supervisors are present. The voting at meetings of the Supervisory Committee shall be conducted in the form of open ballot. Each Supervisor shall have one vote. Supervisors shall attend meetings of the Supervisory Committee in person. If a supervisor is unable to attend for any reason, he/she may appoint another supervisor to attend the meeting on his/her behalf by a written power of attorney specifying the scope of authorization.

The resolutions of Supervisory Committee shall be passed by the votes of more than two-thirds of the members of the Supervisory Committee.

Minutes shall be made for meetings of the Supervisory Committee. The supervisors present at meetings and the person taking minutes shall sign on the minutes. Minutes of meetings of the Supervisory Committee shall be kept by the special person designated by the chairman of Supervisory Committee as corporate files. The minutes of meetings shall be kept for at least 10 years.

Qualifications and obligations of the Company's Directors, Supervisors and senior management

A person may not serve as a director, supervisor, general manager, or any other senior management position of the Company, if he or she:

- (I) is a person without civil capacity or a person with limited capacity for civil conduct;
- (II) is a person who was imposed criminal penalty due to corruption, bribery, embezzlement, appropriation of property or the disruption of the socialist market economic order, and five years have not elapsed from which the punishment or deprivation of political rights for the crimes committed was carried out;
- (III) is a Director, factory Director or manager of bankrupt and liquidated companies or enterprises due to poor operation and management whereby such person was personally liable for the bankruptcy of such companies or enterprises, and three years have not elapsed from which the liquidation of the companies or enterprises was completed;
- (IV) is a legal representative of companies or enterprises which have had their business licenses revoked and the business of such companies or enterprises were compulsorily closed down due to a violation of laws in which such person was personally liable, and three years have not elapsed from which the business license of the Company or enterprise was revoked;
- (V) is a person with relatively large amounts of due and outstanding debt;
- (VI) is a person under investigation by judicial authorities for suspected violations of criminal law and the investigation is still ongoing;

APPENDIX V

SUMMARY OF ARTICLES OF ASSOCIATION

- (VII) is a person cannot assume the position of leader of an enterprise according to laws and administrative regulations;
- (VIII) is a non-natural person;
- (IX) is a person has been ruled as violations of the provisions of relevant securities regulations by the competent authority, involving fraud or dishonesty, and it does not exceed five years from the date of the ruling;
- (X) the circumstances specified by the laws, administrative regulations, the listing rules or relevant laws and regulations of the place where the shares of the Company are listed.

In the case of the election, appointment of directors and supervisors or employment of senior management which violates the above provisions, the election, appointment or employment shall be null and void.

The Directors, Supervisors and senior management that incurs any of the circumstances hereinabove during his or her term of office shall be removed by the Company.

The validity of an act of a Director, general manager and other senior management of the Company on behalf of the Company towards a bona fide third party shall not be affected by any irregularity in his/her current position, election or qualifications.

In addition to obligations imposed by laws, administrative regulations or listing rules of the place(s) on which shares of the Company are listed, the Company's Directors, Supervisors, general manager and other senior management members shall have the following obligations to each shareholder in the exercise of the functions and powers granted to them by the Company:

- (I) not to cause the Company to act beyond the scope of business stipulated in its business license;
- (II) to act honestly in the best interests of the Company;
- (III) not to deprive the Company of its property in any way, including (but not limited to) any opportunities that are favorable to the Company;
- (IV) not to expropriate the individual rights of shareholders, including (without limitation) rights to distribution and voting rights, but excluding corporate reorganization submitted to and approved by the shareholders' general meeting in accordance with the Articles of Association.

APPENDIX V

SUMMARY OF ARTICLES OF ASSOCIATION

The directors, supervisors, general manager and other senior management staff of the Company must, in the performance of their duties, abide by the principles of honesty and credibility and shall not place themselves in a position where there is a conflict between their personal interests and their duties assumed. This principle shall include (but not limited to) the fulfilment of the following obligations:

- (I) to act honestly in the best interests of the Company;
- (II) to exercise powers within the scope of his/her functions and powers and not to act beyond such powers;
- (III) to personally exercise the discretion vested in him/her, not to allow himself/herself to be manipulated by another person and, not to delegate the exercise of his/her discretion to another party unless permitted by laws and administrative regulations or the listing rules of the place where the securities of the Company are listed or with the informed consent of the shareholders' general meeting;
- (IV) to be impartial to shareholders of the same category and of different categories;
- (V) not to conclude a contract or enter into a transaction or arrangement with the Company except as otherwise provided in the Articles of Association, the listing rules of the place where the shares of the Company are listed or with the informed consent of the shareholders' general meeting;
- (VI) not to use the Company's assets for his/her own benefit in any way without the informed consent of the shareholders' general meeting;
- (VII) not to make use of official powers to accept bribes or other illegal income, and not to encroach upon the Company's assets in any way, including (but not limited to) any opportunities that are favorable to the Company;
- (VIII) not to accept commissions in connection with the Company's transactions without the informed consent of the shareholders' general meeting;
- (IX) to abide by the Articles of Association, perform his/her duties faithfully, protect the interests of the Company and not to seek personal gains with his/her position, functions and powers in the Company;
- (X) not to compete with the Company in any way without the informed consent of the shareholders' general meeting;
- (XI) not to misappropriate the funds of the Company or lend them to others, not to deposit the Company's assets in accounts opened in his/her own or in another's name, not to use the Company's assets as security for the debts of the Company's shareholders or other individuals; and

APPENDIX V

SUMMARY OF ARTICLES OF ASSOCIATION

(XII) not to disclose confidential information relating to the Company that was acquired by him/her during his/her term of office without the informed consent of the shareholders' general meeting, and not to use such information except in the interests of the Company; however, such information may be disclosed to the court or other competent government authorities if:

1. provided by law;
2. required in the public interest;
3. required in the own interest of such Director, Supervisor, general manager and other senior management staff.

The fiduciary duty of a Director, Supervisor, general manager and other senior management of the Company does not necessarily cease with the termination of his/her term of office, and their confidentiality obligation to the Company in respect of commercial secrets shall continue after expiry of his/her term of office. The term for continuance of other obligations shall be decided upon in accordance with the principle of fairness, depending on the time lapse between the occurrence of the matter and the termination as well as the circumstances and conditions under which the relationship with the Company terminates.

Except in circumstances otherwise stipulated in the Articles of Association, liabilities of a Director, Supervisor, general manager and other senior management arising from the violation of a specified duty may be released by informed Shareholders in general meeting.

Where a director, supervisor, general manager and other senior management member of the Company is, directly or indirectly, holding a material interest in a contract, transaction or arrangement that the Company has concluded or plans to conclude (excluding any employment contract of the Company with such director, supervisor, general manager and other senior management member), such director, supervisor, general manager and other senior management member shall, as soon as practicable, disclose to the Board of Directors the nature and extent of his or her interest, regardless of whether the issue concerned is subject to the approval of the Board of Directors in normal circumstances.

A director who is connected with an enterprise involved in the resolution made at a Board meeting shall not vote on the said resolution for himself or on behalf of another director and shall abstain from voting. The Board meeting may be held with the quorum of more than half of non-connected directors and resolutions at the Board meeting shall be passed by more than half of non-connected directors. Where the number of non-connected directors present at the Board meeting is less than three, the matter shall be submitted to the shareholders' general meeting of the Company for deliberation.

Unless under the exceptional circumstances specified in the Note 1, Appendix 3 of Hong Kong Listing Rules or otherwise approved by the Hong Kong Stock Exchange, a Director shall not vote on any resolution of the Board approving contract, transaction, arrangement or any

APPENDIX V

SUMMARY OF ARTICLES OF ASSOCIATION

other proposal in which he/she or any of his/her close associates (as defined in the applicable Listing Rules which come into effect from time to time) has a material interest nor shall he/she be counted in the quorum of the meeting. If the relevant contract, transaction, arrangement or proposal involves the connected transaction specified in the Hong Kong Listing Rules, the "close associates" herein shall be changed to "associates" (as defined in the applicable Hong Kong Listing Rules which come into effect from time to time).

A director, supervisor, general manager and other senior management member of the Company shall be deemed to have interests in a contract, transaction or arrangement where his/her connected persons or associates have interests.

The Company shall not in any manner pay taxes for its directors, supervisors, general manager or other senior management.

The Company shall not, directly or indirectly, provide loans or loan guarantees to the Directors, Supervisors, general manager and other senior management members of the Company and its parent Company, nor shall the Company provide the same to connected persons of the above-mentioned persons.

The preceding provisions shall not apply to the following circumstances:

- (I) loans or loan guarantees provided by the Company to its subsidiaries;
- (II) loans, loan guarantees or other funds provided by the Company to the Directors, Supervisors, general manager and other senior management members of the Company pursuant to their employment contracts which were adopted by the Shareholders' general meeting, to cover expenditure incurred for the Company or for performing their duties and responsibilities for the Company; and
- (III) if the normal business activities of the Company include provision of loans and loan guarantees, the Company may provide loans and loan guarantees to the relevant Directors, Supervisors, general manager and other senior management members and their connected persons, provided that the loans and loan guarantees are provided on normal commercial terms.

If the Company provides a loan in breach of the provisions above, regardless of the terms of the loan, the person who has received the loan shall repay it immediately.

The Company shall not be forced to perform the loan guarantee it provided in breach of the Articles of Association, except in the following circumstances:

- (I) the loan provider was not informed at the time that the loan was provided to the connected persons of the Directors, Supervisors, general manager and other senior management members of the Company or its parent company;

APPENDIX V

SUMMARY OF ARTICLES OF ASSOCIATION

- (II) the guarantee provided by the Company has been sold by the loan provider lawfully to a goodwill buyer.

If a Director, a Supervisor, general manager and other senior management of the Company breaches his/her obligations to the Company, the Company shall, in addition to various rights and remedies provided by laws, administrative regulations, listing rules of the place where the Company's shares are listed, have a right to:

- (I) require the relevant Director, Supervisor, general manager and other senior management to compensate for the losses sustained by the Company as a consequence of his/her dereliction of duty;
- (II) rescind any contract or transaction concluded by the Company with the relevant Director, Supervisor, general manager and other senior management, as well as any contract or transaction concluded by the Company with a third party (where such third party is aware or should be aware that the Director, Supervisor, general manager and other senior management representing the Company was in breach of his/her obligations to the Company);
- (III) require the relevant Director, Supervisor, general manager and other senior management to surrender the gains derived from the breach of his/her obligations;
- (IV) recover any funds received by the relevant Director, Supervisor, general manager and other senior management that should have been received by the Company, including (but not limited to) commissions;
- (V) require the relevant Director, Supervisor, general manager and other senior management to repay the interest earned or possibly earned on the funds that should have been given to the Company.

The Company shall enter into written contracts with the Directors and the Supervisors of the Company regarding remuneration which are subject to the prior approval from the Shareholders' general meeting.

Financial Accounting System and Profit Distribution

The Company shall formulate its financial accounting system in accordance with the laws, administrative regulations, and PRC accounting standards formulated by the competent financial authority under the State Council.

The Company shall publish its financial reports twice in each accounting year. An interim financial report shall be published within 60 days after the end of the first six months of each accounting year, while an annual financial report shall be published within 120 days after the end of each accounting year.

APPENDIX V

SUMMARY OF ARTICLES OF ASSOCIATION

Where the securities regulatory authorities at, and listing rules of, the place where the shares of the Company are listed provide otherwise, such provisions shall prevail.

Interim results or financial information published or disclosed by the Company shall be prepared in accordance with China's accounting standards, laws and regulations, and also in accordance with either international accounting standards or that of the overseas listing place.

The Company shall have no other accounting books except the statutory accounting books. The Company's assets shall not be deposited in any account opened in the name of any individual.

Capital reserve shall include the following funds:

- (I) premium obtained from the issue of shares in excess of the par value;
- (II) other revenues required by the competent financial authority under the State Council to be included in the capital reserve.

The common reserve funds of the Company shall be used for making up for the losses of the Company, expanding the Company's business operations or being converted to the Company's capital. The common reserve of a company shall be only applied for the following purposes:

- (I) making up for the losses. The capital reserve shall not be used to recover the losses.
- (II) conversion into share capital. Where the statutory reserve fund is converted into capital by way of capitalization, the balance of the fund shall not be less than 25% of the registered capital of the Company before such conversion.
- (III) expanding the Company's business operations.

Taking the interests of shareholders into full consideration, the Company will implement a reasonable dividend distribution policy based on the Company's business situation and market environment annually. The Company may distribute dividends in cash or by Shares.

When the Company distributes each year's profit after tax, the Company shall allocate 10% of the after-tax profits as the statutory reserve fund of the Company. Such allocations may be stopped when the statutory reserve fund of the Company has accumulated to above 50% of the registered capital of the Company. If the statutory reserve fund of the Company is insufficient to make up for the losses of the preceding year, the profits of the current year shall first be used to make up for the said losses before any statutory reserve fund is allocated as per above.

APPENDIX V

SUMMARY OF ARTICLES OF ASSOCIATION

After the Company has made allocations to the statutory reserve fund from its after-tax profits, it may, upon passing a resolution at a shareholders' general meeting, make further allocations from its after-tax profits to the discretionary reserve fund.

If the shareholder's general meeting or the Board of Directors has, in violation of the provisions in the preceding paragraphs, distributed profits to shareholders before the Company recovered the losses and allocated statutory reserve fund, the profits thus distributed shall be returned to the Company.

The Company shall not be entitled to any distribution of profits in respect of shares held by it.

The Company shall appoint one or more receiving agent(s) for holders of overseas-listed foreign shares. Receiving agent(s) shall receive dividends distributed and other amounts payable on overseas-listed foreign shares by the Company on behalf of relevant shareholders and shall hold such amounts in trust for holders of overseas-listed foreign shares, pending payment to them. The receiving agent(s) appointed by the Company shall meet the requirements of the laws of the place(s) or the relevant regulations of the securities exchange(s) where the shares are listed.

Subject to the relevant laws, regulations, rules, normative documents and relevant regulations of the securities regulatory authorities of places where the Company's shares are listed, the Company may exercise the right to forfeit any unclaimed dividends, but the said right shall not be exercised before expiry of the applicable validity period and such right may only be exercised six years or more after the date of dividends declaration.

Any amount paid up in advance of calls on any share may carry interest but shall not entitle the holders of shares to participate in a dividend subsequently declared in respect of prepaid amount.

Appointment of Internal Audit and Accounting Firm

The Company Shall appoint an independent PRC qualified accounting firm to audit the Company's annual financial report and to review other financial reports.

The first accounting firm of the Company may be appointed by the inaugural meeting prior to the first annual general meeting and the accounting firm so appointed shall hold office until the conclusion of the first annual general meeting. The term of appointment of an accounting firm appointed by the Company shall be between the conclusion of the annual general meeting of the Company and the conclusion of the next annual general meeting and the term of appointment may be renewable upon expiry of the term of appointment.

APPENDIX V

SUMMARY OF ARTICLES OF ASSOCIATION

An accounting firm appointed by the Company shall have the following rights:

- (I) the right to the access to the accounts books, records or vouchers of the Company at any time and the right to require directors, general manager or other senior management of the Company to provide the relevant information and explanations;
- (II) the right to require the Company to take all reasonable measures to obtain from its subsidiaries the information and explanations necessary for the accounting firm to perform its duties;
- (III) the right to attend shareholders' general meeting, to receive a notice or other information concerning any meetings which shareholders have a right to receive, and to be heard at any shareholders' general meetings on any matter which relates to it as the accounting firm of the Company.

The shareholders' general meeting may, by means of an ordinary resolution, dismiss such accounting firm prior to the expiration of its term of appointment, notwithstanding the terms in the contract between the accounting firm and the Company, but without prejudice to such accounting firm's right, if any, to claim damages from the Company in respect of such dismissal.

The remuneration or method of determining the remuneration of an accounting firm shall be decided by the shareholders' general meeting. The remuneration of an accounting firm appointed by the Board of Directors shall be determined by the Board of Directors.

The appointment, dismissal or discontinuation of the appointment of an accounting firm of the Company shall be decided by the shareholders' general meeting and be reported to the State Council's securities regulatory authority for the record.

When the Company decides to dismiss or not to reappoint an accounting firm, it shall give not less than thirty days prior notice to the accounting firm. The accounting firm shall have the right to present its views at shareholders' general meeting. If the accounting firm resigns, it shall state to the shareholders' general meeting whether the Company has committed any misconduct.

An accounting firm may resign from its duties by delivering a written notice of resignation to the Company's legal address. The notice takes effect on the date when it is placed at the Company's legal address or the later date indicated in the notice. The notice should include the following statements:

- (I) a statement to the effect that there are no circumstances connected with its resignation which it considers should be brought to the notice of the shareholders or creditors of the Company; or
- (II) a statement of any circumstances that should be disclosed.

APPENDIX V

SUMMARY OF ARTICLES OF ASSOCIATION

Within fourteen days of receipt of the written notice referred to in the preceding paragraph, the Company shall send a copy of such notice to the relevant competent authority. If the notice contains a statement referred to in subparagraph (ii) of the preceding paragraph, the Company shall make a copy of such statement available for inspection by the shareholders at the Company. The Company shall also deliver a copy of the aforesaid statement to every shareholder entitled to receive the financial condition report of the Company with recipients' addresses as shown in the share register.

If the resignation notice of the accounting firm contains a statement mentioned in subparagraph (ii) above, the accounting firm may request the Board to convene an extraordinary general meeting to hear its explanation on the resignation.

Merger, Division, Increase and Decrease of Capital, Dissolution and Liquidation of the Company

In the event of the merger or division of the Company, a plan shall be proposed by the Board of the Company and shall be approved in accordance with the procedures stipulated in the Articles of Association and the relevant examining and approving formalities shall be processed as required by law. Shareholders who oppose to the plan of merger or division of the Company shall be entitled to require the Company or the shareholders who agree to the plan to purchase their shares at a fair price. The resolutions approving the merger or division of the Company shall be compiled into special document and made available for inspection by shareholders. The aforesaid document shall also be dispatched to each holder of overseas-listed foreign shares by mail with recipients' addresses as shown in the share register.

A merger of the Company may take the form of either merger by absorption or merger by establishment of a new company.

Merger by absorption shall mean that the Company absorbs other companies and the absorbed companies are dissolved. Merger by establishment of a new company shall refer to the establishment of a new company as a result of merger of two or more companies and dissolution of the parties being merged.

In the event of merger of the Company, the parties to the merger shall enter into a merger agreement and prepare balance sheet and asset list. The Company shall, within ten days from making the decision of merger, notify the creditors, and shall publish an announcement in a newspaper within thirty days. The creditors may, within thirty days from the date of receipt of the notice or within forty-five days from the date of the announcement if they fail to receive such notice, require the Company to clear off its debts or to provide corresponding guarantees. After the merger of the Company, the credits and debts of parties to the merger shall be succeeded by the surviving company or by the newly established company.

As for the division of the Company, the properties thereof shall be divided accordingly.

APPENDIX V

SUMMARY OF ARTICLES OF ASSOCIATION

In the event of division of the Company, the parties to the division shall enter into a division agreement and prepare balance sheet and asset list. The Company shall, within ten days from making the decision of division, notify the creditors and publish an announcement in a newspaper within thirty days. Debts incurred by the Company before its division shall be borne by the companies after the division according to the agreement reached.

When reducing its registered capital, the Company must prepare balance sheet and an asset list.

The Company shall, within ten days from making the resolution on reducing registered capital, notify the creditors and publish an announcement in a newspaper within thirty days. The creditors may, within thirty days from the date of receipt of the notice or within forty-five days from the date of the announcement if they fail to receive a notice, require the Company to clear off its debts or to provide corresponding guarantees.

The registered capital of the Company after its reduction shall not be less than the statutory minimum amount.

Where the merger or division of the Company involves changes in its registered particulars, such changes shall be filed with company registration authorities according to the law. In accordance with the laws, cancelation of a company shall be registered when a company is dissolved and incorporation of a company shall be registered when a new company is incorporated.

Increase or decrease of the registered capital of the Company shall be registered with the company registration authorities in accordance with the laws.

The Company shall be dissolved and liquidated according to law in any of the following circumstances:

- (I) upon expiry of term of business stipulated in the Articles of Association or occurrence of other circumstances of dissolution stipulated in the Articles of Association;
- (II) the shareholders' general meeting has resolved on dissolution of the Company;
- (III) merger or division of the Company entails dissolution;
- (IV) the Company is declared bankrupt according to law as it is unable to repay its debts upon maturity;
- (V) the Company's business license is cancelled pursuant to the law, or the Company is ordered to be closed down or revoked pursuant to the law;

APPENDIX V

SUMMARY OF ARTICLES OF ASSOCIATION

(VI) the Company can be dissolved by the people's court in response to the request of shareholders holding shares that represent more than 10% of the voting rights of all shareholders of the Company, on the grounds that the operation and management of the Company has suffered serious difficulties that cannot be resolved through other means, and continuation may incur significant losses of the interests of the shareholders.

In the circumstance of subparagraph (I) of the preceding Article, the Articles of Association may be amended so that the Company can continue to exist. Where the Company is dissolved pursuant to sub-paragraphs (I), (II) and (VI) of the preceding Article, a liquidation committee shall be set up within fifteen days and the composition of the liquidation committee shall be determined by an ordinary resolution of the shareholders' general meeting.

If the Company is dissolved pursuant to subparagraph (IV) of the preceding Article, the people's court shall, according to the relevant laws and regulations, organize shareholders, relevant institutions and professionals to establish liquidation committee and carry out liquidation.

If the Company is dissolved pursuant to subparagraph (V) of the preceding Article, the relevant competent authorities shall organize shareholders, relevant institutions and professionals to establish liquidation committee and carry out liquidation.

If a liquidation committee is not set up within the time limit specified herein, the creditor may apply to the people's court for the court to designate relevant persons to form a liquidation committee and carry out the liquidation. The people's court should accept such application and form a liquidation committee to conduct liquidation in a timely manner.

Where the Board of Directors proposes to liquidate the Company (due to causes other than where the Company has declared that it is insolvent), it shall declare in the notice of the shareholders' general meeting to be convened for such purpose that after making full inquiry into the affairs of the Company, the Board of Directors is of the opinion that the Company will be able to pay its debts in full within 12 months from the commencement of the liquidation.

Upon the passing of the resolution at the shareholders' general meeting for the liquidation, all functions and powers of its Board of Directors of the Company shall cease immediately.

The liquidation committee shall act in accordance with the instructions of the shareholders' general meeting to make a report at least once every year to the shareholders' general meeting on the liquidation committee's receipts and payments, the business of the Company and the progress of the liquidation and to present a final report at the shareholders' general meeting on completion of the liquidation.

APPENDIX V

SUMMARY OF ARTICLES OF ASSOCIATION

The liquidation committee shall notify the creditors within ten days after its establishment and shall publish announcements on the newspaper within sixty days. The creditors shall declare their creditor's rights to the liquidation committee within thirty days after receipt of the notice or forty-five days after announcement if the creditors have not received the notice.

Creditors declaring creditor's rights shall state the relevant information of the creditor's rights and provide evidentiary materials. The liquidation committee shall register the creditor's rights according to the laws and regulations.

During the period for declaration of creditor's rights, the liquidation committee shall not make repayment to creditors.

During liquidation, the liquidation committee shall exercise the following functions and powers:

- (I) to ascertain the Company's assets and separately prepare balance sheet and asset list;
- (II) to inform creditors by notice or announcement;
- (III) to deal with the Company's outstanding business in relation to the liquidation;
- (IV) to settle outstanding taxes and taxes incurred during the process of liquidation;
- (V) to ascertain all creditor's rights and debts;
- (VI) to dispose of the remaining assets of the Company after the repayment of debts;
- (VII) to represent the Company in any civil proceedings.

After the liquidation committee has liquidated the assets of the Company and prepared balance sheet and asset list, it shall formulate a liquidation proposal and submit it to the shareholders' general meeting or the relevant competent authorities for confirmation.

The assets of the Company shall be liquidated in the following order of priority: payment of liquidation expenses, employee wages, social insurance expenses and statutory compensation, outstanding taxes and the Company's debts.

The remaining assets of the Company after liquidation in accordance with the preceding paragraph shall be distributed to shareholders of the Company based on the class and proportion of the shares held by them.

The Company continues to exist during the liquidation period, but it shall not engage in any operating activities irrelevant to the liquidation.

APPENDIX V

SUMMARY OF ARTICLES OF ASSOCIATION

The Company's assets shall not be distributed to shareholders before repayments are made in accordance with the provision described above.

If, after sorting out the Company's assets and preparing a balance sheet and an asset list in connection with the liquidation of the Company due to its dissolution, the liquidation committee discovers that the Company's assets are insufficient to repay the Company's debts in full, it shall immediately apply to the people's court for a declaration of bankruptcy. After the Company is declared bankrupt by a ruling of the people's court, the liquidation committee shall hand over all matters related to the liquidation to the people's court.

Upon completion of liquidation of the Company, the liquidation committee shall prepare a liquidation report, income and expenditure statements and account books in respect of the liquidation period and shall, after verification of the Chinese certified public accountants, submit the same to the shareholders' general meeting or the relevant competent authorities for confirmation. Within thirty days from the date of confirmation by the shareholders' general meeting or the relevant competent authorities, the liquidation committee shall submit the aforesaid documents to company registration authorities and apply for deregistration and make an announcement on termination of the Company.

PROCEDURES FOR AMENDMENTS TO THE ARTICLES OF ASSOCIATION

Under any of the following circumstances, the Company shall amend the Articles of Association:

- (I) anything as contained in the Articles of Association is inconsistent with the amended laws and administrative regulations after the PRC Company Law or the relevant laws and administrative regulations are revised;
- (II) the Company's situation has changed and is inconsistent with that set forth under the Articles of Association;
- (III) the shareholders' general meeting has decided on making amendments to the Articles of Association.

Where the amendments to the Articles of Association involve anything as contained in the Mandatory Provisions, such amendments shall become effective upon approval by the company approval department authorized by the State Council and the securities regulatory authority of the State Council. If there is any change relating to the registered particulars of the Company, application shall be made for change in registration in accordance with the law.

APPENDIX V

SUMMARY OF ARTICLES OF ASSOCIATION

Notices and Announcements

A notice of the Company may be given in the following ways:

- (I) by hand;
- (II) by mail;
- (III) by fax or email;
- (IV) by posting on the websites designated by the Company and the Hong Kong Stock Exchange, subject to laws, administrative regulations and listing rules of the place where the Company’s shares are listed;
- (V) by announcement;
- (VI) by other means agreed by the Company or the recipient of the notice in advance or as accepted by the recipient of the notice upon receiving such notice; or
- (VII) by other means approved by the relevant regulatory authority of the place where the Company’s shares are listed or as specified in the Articles of Association.

Unless the context otherwise required, the “announcement” referred to in the Articles of Association means, as to the announcements made to the holders of domestic shares or the announcements required to be made in the PRC in accordance with the relevant provisions and the Articles of Association, an announcement published on any newspaper in the PRC which shall be specified by the PRC laws and regulations, or as designated, agreed or permitted by the securities regulatory authority of the State Council; or as to the announcements made to holders of H shares of the Company or the announcements required to be made in Hong Kong in accordance with the relevant regulations and the Articles of Association, such announcement must be published in a newspaper and/or other designated media (including a website) in accordance with the requirements of the relevant listing rules.

Unless otherwise provided in the Articles of Association, where a notice delivered by the Company to the holders of H shares is delivered by way of an announcement, the Company shall submit an electronic version to the Hong Kong Stock Exchange through the electronic publication system of Hong Kong Stock Exchange on the same day for publication on the website of the Hong Kong Stock Exchange in real-time in accordance with Hong Kong Listing Rules, or publish an announcement on the newspapers (including an advertisement on the newspapers) as required under the Hong Kong Listing Rules. The announcement shall be published on the Company’s website at the same time. In addition, unless otherwise provided in the Articles of Association, service must be made by hand or by prepaid mail at the address of each holder of overseas listed foreign shares registered in the register of members, so as to ensure that each shareholder is well informed and has sufficient time to exercise his/her rights or act in accordance with the terms of the notice.

APPENDIX V

SUMMARY OF ARTICLES OF ASSOCIATION

The holders of overseas listed foreign shares of the Company may choose in writing to receive corporate communications to be dispatched to the shareholders from the Company by electronic means or by mail, and may choose to receive only the Chinese version or English version, or both. The shareholders may also notify the Company in writing in advance within a reasonable time to change the way to receive the foresaid information and in which language on appropriate procedures.

If a shareholder or director intends to prove that any notice, document, information or written statement has been served to the Company, evidences showing that such notice, document, information or written statement has been served in an ordinary manner or by prepaid mail to the correct address within the specified time shall be provided.

Notwithstanding the aforesaid provision explicitly stipulating to provide and/or distribute corporate communications to shareholders in writing, in respect of the manner in which the Company provides and/or distributes corporate communications to shareholders in accordance with Hong Kong Listing Rules, if the Company obtained the prior written or implied consent of such shareholder in accordance with the relevant provisions of the relevant laws and regulations as well as the Hong Kong Listing Rules as amended from time to time, the Company may send or provide corporate communications to the shareholder by electronic means or by publication on the Company’s website. Corporate communications include but are not limited to the below: circulars, annual reports, interim reports, notices of shareholders’ general meetings and other corporate communications listed in the Hong Kong Listing Rules.

Settlement of Disputes

The Company follows the following rules for the settlement of disputes:

- (I) Any dispute and claim between holders of overseas listed foreign shares and the Company, between holders of overseas listed foreign shares and the Company’s Directors, Supervisors and senior management, or between holders of overseas listed foreign shares and holders of domestic shares with respect to any rights or obligations under the Articles of Association, the PRC Company Law or any other relevant laws and administrative regulations concerning the affairs of the Company shall be submitted by relevant parties for arbitration.

The aforesaid dispute or claim shall be submitted for arbitration as a whole; all parties involved in the same dispute or claim or who are required to participate in the settlement of the dispute or claim shall abide by the arbitration if they are the Company or the shareholders, Directors, Supervisors, or senior management of the Company.

Disputes with respect to the definition of shareholders and disputes concerning the register of members need not to be resolved by arbitration.

APPENDIX V

SUMMARY OF ARTICLES OF ASSOCIATION

- (II) A claimant may choose arbitration either at the China International Economic and Trade Arbitration Commission in accordance with its arbitration rules or at the Hong Kong International Arbitration Centre in accordance with its securities arbitration rules. Once the claimant submits a dispute or claim to arbitration, the other party must carry out the arbitration at the arbitration institution selected by the claimant.

If the claimant choose arbitration at the Hong Kong International Arbitration Centre, either party may request for the arbitration to be conducted in Shenzhen in accordance with the securities arbitration rules of the Hong Kong International Arbitration Centre.

- (III) If any disputes or claims set out in (I) are referred to arbitration, the laws of the People's Republic of China shall apply, save as otherwise specified by laws and administrative regulations.
- (IV) The award of an arbitration institution shall be final and conclusive and binding on all parties.

APPENDIX VI

STATUTORY AND GENERAL INFORMATION

FURTHER INFORMATION ABOUT OUR COMPANY

Incorporation

Our Company was established as a limited liability company in the PRC on January 20, 2011 and was converted into a joint stock limited company on November 6, 2020 under the laws of the PRC. As of the Latest Practicable Date, the registered share capital of our Company was RMB360,000,000.

Our Company [has established] a place of business in Hong Kong at [40/F, Dah Sing Financial Centre, 248 Queen’s Road East, Wanchai, Hong Kong] and [has been] registered as a non-Hong Kong company in Hong Kong under Part 16 of the Companies Ordinance on [●], 2021. Mr. Zhang Mengchi, one of our joint company secretaries, has been appointed as our agent for the acceptance of service of process in Hong Kong whose correspondence address is the same as our place of business.

As we are established in the PRC, our corporate structure and Articles of Association are subject to the relevant laws and regulations of the PRC. A summary of the relevant provisions of our Articles of Association is set out in “Appendix V—Summary of Articles of Association.” A summary of certain relevant aspects of the laws and regulations of the PRC is set out in “Appendix IV—Summary of Principal Legal and Regulatory Provisions.”

Changes in Share Capital

On January 20, 2011, the predecessor of our Company, MicroTech Medical was incorporated with a registered capital of RMB27.78 million.

The following sets out the changes in the share capital of our Company during the two years immediately preceding the date of this Document:

On December 25, 2019, pursuant to a capital increase agreement entered into by Hangzhou Hengtai and our Company, Hangzhou Hengtai agreed to subscribe for the increased registered capital of RMB4,151,136 of our Company at a total consideration of RMB4,151,136, the total issued capital of our Company increased from RMB78,871,579 to RMB83,022,715.

On November 8, 2020, pursuant to a capital increase agreement with the relevant [REDACTED] Investors, the terms of which are summarized in the paragraph headed “History, Development and Corporate structure—(2) [REDACTED] Investments and Major Shareholding Changes of Our Company—(m) Series D Financing (November 2020 Capital Increase)”, the total issued share capital of our Company increased from RMB83,022,715 to RMB95,195,805.

APPENDIX VI

STATUTORY AND GENERAL INFORMATION

On December 9, 2020, pursuant to a shareholders’ resolution of our Company, the registered capital of our Company was increased from RMB95,195,805 to RMB360,000,000. The increased registered capital of RMB264,804,195 was all converted from the capital reserves of our Company.

For more details, see “History, Development and Corporate Structure—Establishment and Development of Our Company.” Save as aforesaid, as of the Latest Practicable Date, there had been no alterations of our share capital within the two years preceding the date of publication of this Document.

Corporate Reorganization

Our Company has not gone through any corporate reorganization. For details of the history and development of our Company, see “History, Development and Corporate Structure.”

Resolutions of our Shareholders

Pursuant to a general meeting held on April 21, 2021, among other things, our Shareholders resolved that:

- (a) the issuance by our Company of the H Shares of nominal value of RMB1.00 each and such H Shares being [REDACTED] on the Hong Kong Stock Exchange;
- (b) the number of H Shares to be issued shall not be more than [REDACTED] of the total issued share capital of our Company as enlarged by the [REDACTED], and the grant to the [REDACTED] (or their representatives) of the [REDACTED] of not more than [REDACTED] of the number of H Shares issued pursuant to the [REDACTED];
- (c) subject to the completion of the [REDACTED], the adoption of the Articles of Association which shall become effective on the [REDACTED], and authorization to the Board to amend the Articles of Association in accordance with the requirements of the relevant laws and regulations and the Listing Rules; and
- (d) authorization of the Board to handle all matters relating to, among other things, the [REDACTED], the issue and [REDACTED] of the H Shares.

Changes in Share Capital of our Subsidiary

Our subsidiary as of the Latest Practicable Date are set out in “History, Development and Corporate Structure—Our Subsidiary.”

As at the Latest Practicable Date, the registered capital of MicroTech E-Commerce was RMB1,000,000 and there has not been any changes in its registered capital within two years immediately preceding the date of this Document.

APPENDIX VI

STATUTORY AND GENERAL INFORMATION

FURTHER INFORMATION ABOUT OUR BUSINESS

Summary of Material Contracts

We have entered into the following contracts (not being contracts entered into in the ordinary course of business) within the two years immediately preceding the date of this Document that are or may be material:

1. the capital and equity increase agreement dated December 25, 2019 entered into by Hangzhou Hengtai Brand Management Partnership (Limited Partnership) (杭州衡泰品牌管理合夥企業(有限合夥)) and MicroTech Medical (Hangzhou) Company Limited (微泰醫療器械(杭州)有限公司) (the predecessor of our Company);
2. the supplemental investment agreement dated May 7, 2020 entered into by Suzhou Qiming Ronghe Venture Capital Partnership (Limited Partnership) (蘇州啟明融合創業投資合夥企業(有限合夥)), QM32 Limited, Jiangsu Jiequan Lize Health Industry Venture Capital Fund (Limited Partnership) (江蘇韋泉禮澤健康產業創業投資基金(有限合夥)), Suzhou Likang Equity Investment Center (Limited Partnership) (蘇州禮康股權投資中心(有限合夥)), Mr. Zhu Liuping (朱六平), Dr. Zheng Pan (鄭攀), Mr. Dore Chin Mark, Power SUM Limited, Hangzhou Jiufu Equity Investment Partnership (Limited Partnership) (杭州九賦股權投資合夥企業(有限合夥)), Haining Jiuyao Equity Investment Partnership (Limited Partnership) (海寧九曜股權投資合夥企業(有限合夥)), Hangzhou Zibo Investment Management Partnership (Limited Partnership) (杭州紫博投資管理合夥企業(有限合夥)), Hangzhou Chende Investment Partnership (Limited Partnership) (杭州辰德投資合夥企業(有限合夥)), LAV Evergreen (Hong Kong) Co., Limited, Shanghai Li'an Venture Capital Center (Limited Partnership) (上海禮安創業投資中心(有限合夥)), Hangzhou Yantai Investment Partnership (Limited Partnership) (杭州研泰投資合夥企業(有限合夥)), Hangzhou Hengtai Brand Management Partnership (Limited Partnership) (杭州衡泰品牌管理合夥企業(有限合夥)), Jiaxing Furui Equity Investment Partnership (Limited Partnership) (嘉興福銳股權投資合夥企業(有限合夥)), Hangzhou Yunbo Investment Partnership (Limited Partnership) (杭州雲帛投資合夥企業(有限合夥)), Hangzhou Jiuge Equity Investment Partnership (Limited Partnership) (杭州九歌股權投資合夥企業(有限合夥)), Shanghai Zouzhen Enterprise Service Center (Limited Partnership) (上海奏臻企業服務中心(有限合夥)) and MicroTech Medical (Hangzhou) Company Limited (微泰醫療器械(杭州)有限公司) (the predecessor of our Company);
3. the second supplemental capital increase agreement dated September 30, 2020 entered into by MicroTech Medical (Hangzhou) Company Limited (微泰醫療器械(杭州)有限公司) (the predecessor of our Company), Dr. Zheng Pan (鄭攀), LAV Evergreen (Hong Kong) Co., Limited and Shanghai Li'an Venture Capital Center (Limited Partnership) (上海禮安創業投資中心(有限合夥));

APPENDIX VI

STATUTORY AND GENERAL INFORMATION

4. the second supplemental capital increase and equity transfer agreement dated September 30, 2020 entered into by MicroTech Medical (Hangzhou) Company Limited (微泰醫療器械(杭州)有限公司) (the predecessor of our Company), Dr. Zheng Pan (鄭攀), Suzhou Qiming Ronghe Venture Capital Partnership (Limited Partnership) (蘇州啟明融合創業投資合夥企業(有限合夥)), QM32 Limited, Hangzhou Zibo Investment Management Partnership (Limited Partnership) (杭州紫博投資管理合夥企業(有限合夥)), Hangzhou Jiuyao Equity Investment Partnership (Limited Partnership) (杭州九瑛股權投資合夥企業(有限合夥)), Hangzhou Jiufu Equity Investment Partnership (Limited Partnership) (杭州九賦股權投資合夥企業(有限合夥)), Hangzhou Chende Investment Partnership (Limited Partnership) (杭州辰德投資合夥企業(有限合夥)), Power SUM Limited;
5. the second supplemental investment agreement dated September 30, 2020 entered into by MicroTech Medical (Hangzhou) Company Limited (微泰醫療器械(杭州)有限公司) (the predecessor of our Company), Dr. Zheng Pan (鄭攀), Jiangsu Jiequan Lize Health Industry Venture Capital Fund (Limited Partnership) (江蘇赴泉醴澤健康產業創業投資基金(有限合夥)), Jiaxing Furui Equity Investment Partnership (Limited Partnership) (嘉興福銳股權投資合夥企業(有限合夥)), Hangzhou Yunbo Investment Partnership (Limited Partnership) (杭州雲帛投資合夥企業(有限合夥)), Hangzhou Jiuge Equity Investment Partnership (Limited Partnership) (杭州九歌股權投資合夥企業(有限合夥)), QM32 Limited, Suzhou Qiming Ronghe Venture Capital Partnership (Limited Partnership) (蘇州啟明融合創業投資合夥企業(有限合夥)), Suzhou Likang Equity Investment Center (Limited Partnership) (蘇州禮康股權投資中心(有限合夥)), Mr. Zhu Liuping (朱六平) and Shanghai Zouzhen Enterprise Service Center (Limited Partnership) (上海奏臻企業服務中心(有限合夥));
6. the investment agreement dated November 8, 2020 entered into by Zhangjiagang Taikang Qianzhen Equity Investment Partnership (Limited Partnership) (張家港泰康乾貞股權投資合夥企業(有限合夥)), Shenzhen Tencent Information Technology Co., Ltd. (深圳市騰訊信息技術有限公司), Zhuhai Yitai Management Consulting Enterprise (Limited Partnership) (珠海屹泰管理諮詢企業(有限合夥)), Suzhou Chenzhide Investment Partnership (Limited Partnership) (蘇州辰知德投資合夥企業(有限合夥)), Nanjing Jianye Sanzheng Shunxin Equity Investment Partnership (Limited Partnership) (南京建鄴叁正順心股權投資合夥企業(有限合夥)), CICC Pucheng Investment Co., Ltd. (中金浦成投資有限公司), Shanghai Guangkong Guanghai Equity Investment Center (Limited Partnership) (上海光控光海股權投資中心(有限合夥)), Mr. Teng Rongsong (滕榮松), Dr. Zheng Pan (鄭攀), Mr. Dore Chin Mark, Hangzhou Yantai Investment Partnership (Limited Partnership) (杭州研泰投資合夥企業(有限合夥)), Hangzhou Hengtai Brand Management Partnership (Limited Partnership) (杭州衡泰品牌管理合夥企業(有限合夥)), LAV Evergreen (Hong Kong) Co., Limited, Shanghai Li'an Venture Capital Center (Limited Partnership) (上海禮安創業投資中心(有限合夥)), Suzhou Likang Equity Investment Center (Limited Partnership) (蘇州禮康股權投資中心(有限合夥)), Suzhou Qiming Ronghe Venture Capital Partnership (Limited Partnership) (蘇州啟明融合創業投資合夥企業(有限合夥)), QM32 Limited, QM153 Limited, Hangzhou Jiufu Equity Investment Partnership (Limited Partnership) (杭州九賦股權投資合夥企業(有限合夥));

APPENDIX VI

STATUTORY AND GENERAL INFORMATION

- 夥)), Hangzhou Jiuyao Equity Investment Partnership (Limited Partnership) (杭州九珽股權投資合夥企業(有限合夥)), Power SUM Limited, Hangzhou Chende Investment Partnership (Limited Partnership) (杭州辰德投資合夥企業(有限合夥)), Hangzhou Zibo Investment Management Partnership (Limited Partnership) (杭州紫博投資管理合夥企業(有限合夥)), Jiangsu Jiequan Lize Health Industry Venture Capital Fund (Limited Partnership) (江蘇韋泉醴澤健康產業創業投資基金(有限合夥)), Shanghai Zouzhen Enterprise Service Center (Limited Partnership) (上海奏臻企業服務中心(有限合夥)), Mr. Zhu Liuping (朱六平), Hangzhou Yunbo Investment Partnership (Limited Partnership) (杭州雲帛投資合夥企業(有限合夥)), Hangzhou Jiuge Equity Investment Partnership (Limited Partnership) (杭州九歌股權投資合夥企業(有限合夥)), Jiaxing Furui Equity Investment Partnership (Limited Partnership) (嘉興福銳股權投資合夥企業(有限合夥)) and our Company;
7. the third supplemental capital increase agreement dated April 16, 2021 entered into by the Company, Dr. Zheng Pan (鄭攀), LAV Evergreen (Hong Kong) Co., Limited and Shanghai Li'an Venture Capital Center (Limited Partnership) (上海禮安創業投資中心(有限合夥));
8. the third supplemental capital increase and equity transfer agreement dated April 16, 2021 entered into by the Company, Dr. Zheng Pan (鄭攀), Suzhou Qiming Ronghe Venture Capital Partnership (Limited Partnership) (蘇州啟明融合創業投資合夥企業(有限合夥)), QM32 Limited, Hangzhou Zibo Investment Management Partnership (Limited Partnership) (杭州紫博投資管理合夥企業(有限合夥)), Hangzhou Jiuyao Equity Investment Partnership (Limited Partnership) (杭州九珽股權投資合夥企業(有限合夥)), Hangzhou Jiufu Equity Investment Partnership (Limited Partnership) (杭州九賦股權投資合夥企業(有限合夥)), Hangzhou Chende Investment Partnership (Limited Partnership) (杭州辰德投資合夥企業(有限合夥)) and Power SUM Limited;
9. the third supplemental investment agreement dated April 16, 2021 entered into by the Company, Dr. Zheng Pan (鄭攀), Jiangsu Jiequan Lize Health Industry Venture Capital Fund (Limited Partnership) (江蘇韋泉醴澤健康產業創業投資基金(有限合夥)), Jiaxing Furui Equity Investment Partnership (Limited Partnership) (嘉興福銳股權投資合夥企業(有限合夥)), Hangzhou Yunbo Investment Partnership (Limited Partnership) (杭州雲帛投資合夥企業(有限合夥)), Hangzhou Jiuge Equity Investment Partnership (Limited Partnership) (杭州九歌股權投資合夥企業(有限合夥)), QM32 Limited, Suzhou Qiming Ronghe Venture Capital Partnership (Limited Partnership) (蘇州啟明融合創業投資合夥企業(有限合夥)), Suzhou Likang Equity Investment Center (Limited Partnership) (蘇州禮康股權投資中心(有限合夥)), Mr. Zhu Liuping (朱六平) and Shanghai Guofang Zouzhen Enterprise Service Center (Limited Partnership) (上海國方奏臻企業服務中心(有限合夥));

APPENDIX VI

STATUTORY AND GENERAL INFORMATION

10. the supplemental investment and shareholders’ agreement dated April 16, 2021 entered into by Dr. Zheng Pan (鄭攀), Mr. Dore Chin Mark, Hangzhou Yantai Investment Partnership (Limited Partnership) (杭州研泰投資合夥企業(有限合夥)), Hangzhou Hengtai Brand Management Partnership (Limited Partnership) (杭州衡泰品牌管理合夥企業(有限合夥)), LAV Evergreen (Hong Kong) Co., Limited, Shanghai Li’an Venture Capital Center (Limited Partnership) (上海禮安創業投資中心(有限合夥)), Suzhou Likang Equity Investment Center (Limited Partnership) (蘇州禮康股權投資中心(有限合夥)), Suzhou Qiming Ronghe Venture Capital Partnership (Limited Partnership) (蘇州啟明融合創業投資合夥企業(有限合夥)), QM32 Limited, QM153 Limited, Hangzhou Jiufu Equity Investment Partnership (Limited Partnership) (杭州九賦股權投資合夥企業(有限合夥)), Hangzhou Jiuyao Equity Investment Partnership (Limited Partnership) (杭州九珽股權投資合夥企業(有限合夥)), Power SUM Limited, Hangzhou Chende Investment Partnership (Limited Partnership) (杭州辰德投資合夥企業(有限合夥)), Hangzhou Zibo Investment Management Partnership (Limited Partnership) (杭州紫博投資管理合夥企業(有限合夥)), Jiangsu Jiequan Lize Health Industry Venture Capital Fund (Limited Partnership) (江蘇走泉醴澤健康產業創業投資基金(有限合夥)), Shanghai Guofang Zouzhen Enterprise Service Center (Limited Partnership) (上海國方奏臻企業服務中心(有限合夥)), Mr. Zhu Liuping (朱六平), Hangzhou Yunbo Investment Partnership (Limited Partnership) (杭州雲帛投資合夥企業(有限合夥)), Hangzhou Jiuge Equity Investment Partnership (Limited Partnership) (杭州九歌股權投資合夥企業(有限合夥)), Jiaxing Furui Equity Investment Partnership (Limited Partnership) (嘉興福銳股權投資合夥企業(有限合夥)), Zhangjiagang Taikang Qianzhen Equity Investment Partnership (Limited Partnership) (張家港泰康乾貞股權投資合夥企業(有限合夥)), Shenzhen Tencent Information Technology Co., Ltd. (深圳市騰訊信息技術有限公司), Zhuhai Yitai Management Consulting Enterprise (Limited Partnership) (珠海屹泰管理諮詢企業(有限合夥)), Suzhou Chenzhide Investment Partnership (Limited Partnership) (蘇州辰知德投資合夥企業(有限合夥)), Nanjing Jianye Sanzheng Shunxin Equity Investment Partnership (Limited Partnership) (南京建鄴叁正順心股權投資合夥企業(有限合夥)), CICC Pucheng Investment Co., Ltd. (中金浦成投資有限公司), Shanghai Guangkong Guanghai Equity Investment Center (Limited Partnership) (上海光控光海股權投資中心(有限合夥)), Mr. Teng Rongsong (滕榮松) and the Company; and
11. [REDACTED]

APPENDIX VI STATUTORY AND GENERAL INFORMATION

Intellectual Property Rights

Trademarks



As of the Latest Practicable Date, we had registered the following trademarks which we consider to be or may be material to our business:

No.	Trademark Registered	Place of Registration	Class	Registration Number	Date of Registration	Validity Period
1.	微甜圈	PRC	35	44782383	December 7, 2020	10 years
2.		PRC	10	44782378	December 7, 2020	10 years
3.		PRC	9	44780844	December 7, 2020	10 years
4.		PRC	44	44759713	December 7, 2020	10 years
5.		PRC	9	40316796	September 14, 2020	10 years
6.		PRC	10	38717144	February 7, 2020	10 years
7.	AIDEX	PRC	10	36457593	October 21, 2019	10 years
8.	迅优	PRC	10	15875578	February 7, 2016	10 years
9.		PRC	10	15875536	February 7, 2016	10 years
10.		PRC	10	12488647	September 28, 2014	10 years
11.	微泰	PRC	10	12488597	September 28, 2014	10 years
12.	倍稳	PRC	10	12488419	September 28, 2014	10 years
13.	EXACTIVE	PRC	10	12488378	September 28, 2014	10 years
14.		PRC	10	12488240	September 28, 2014	10 years

APPENDIX VI STATUTORY AND GENERAL INFORMATION

No.	Trademark Registered	Place of Registration	Class	Registration Number	Date of Registration	Validity Period
15.	equil	European Union	10	1507980	June 22, 2020	10 years
16.		United Kingdom	10	1507980	October 20, 2020	10 years
17.		Australia	10	1507980	December 10, 2019	10 years
18.		Russia	10	1507980	February 8, 2021	10 years
19.		Japan	10	1507980	February 18, 2021	10 years
20.	aidex	European Union	10	1526648	September 15, 2020	10 years
21.		United States	10	6219096	December 15, 2020	10 years
22.		United Kingdom	10	1526648	January 5, 2021	10 years

As of the Latest Practicable Date, we had applied for the registration of the following trademarks, which we consider to be material to our business:

No.	Trademark Registered	Place of Registration	Class	Application Number	Application Date
1.	 微泰医疗 WT MICROTECH MEDICAL	Hong Kong	10	305563585	March 16, 2021
2.	 MicroTech Medical	Hong Kong	10	305563576	March 16, 2021

Patents

See “Business—Intellectual Property Rights” for patents registered as of the Latest Practicable Date which we consider to be or may be material to our business.

Domain Name

As of the Latest Practicable Date, we had registered the following internet domain name which we consider to be or may be material to our business:

No.	Domain Name	Owner	Registration Date
1.	www.microtechmd.com	Company	March 23, 2011

APPENDIX VI STATUTORY AND GENERAL INFORMATION

FURTHER INFORMATION ABOUT OUR DIRECTORS, SUPERVISORS, SENIOR MANAGEMENT AND SUBSTANTIAL SHAREHOLDERS

1. Disclosure of Interests

Save as disclosed below, immediately following the completion of the [REDACTED] (assuming that the [REDACTED] is not exercised), so far as our Directors are aware, none of our Directors, Supervisors or chief executive has any interests or short positions in our Shares, underlying shares and debentures of our Company or any associated corporations (within the meaning of Part XV of the SFO) which will have to be notified to our Company and the Hong Kong Stock Exchange pursuant to Divisions 7 and 8 of Part XV of the SFO (including interests and short positions which they are taken or deemed to have under such provisions of the SFO) or which will be required, pursuant to Section 352 of the SFO, to be recorded in the register referred to therein or which will be required to be notified to our Company and the Hong Kong Stock Exchange pursuant to the Model Code for Securities Transactions by Directors of Listed Companies contained in the Listing Rules.

(a) Interests in our Company

Name	Position	Nature of Interest	Number and class of Shares held ⁽¹⁾	Approximate percentage of shareholding in the total share capital of our Company as of the date of this Document (%)	Approximate percentage of shareholding in the relevant class of Shares after the [REDACTED] ⁽¹⁾ (%)	Approximate percentage of shareholding in the total share capital of our Company after the [REDACTED] (%)
Dr. Zheng ⁽²⁾	Executive Director	Beneficial owner	88,278,594 Domestic Shares	24.52	[REDACTED]	[REDACTED]
		Interest in controlled corporations	34,729,562 Domestic Shares	9.65	[REDACTED]	
Mr. Hu Xubo ⁽³⁾	Non-Executive Director	Interest in controlled corporations	16,055,165 Domestic Shares	4.46	[REDACTED]	[REDACTED]

Notes:

- (1) As the Unlisted Foreign Shares held by QM32 Limited, LAV Evergreen (Hong Kong) Co., Limited, Power SUM Limited and QM153 Limited will not be converted into H Shares upon [REDACTED], the calculation is based on the total number of 286,473,574 Domestic Shares in issue, 73,526,426 Unlisted Foreign Shares in issue and [REDACTED] H Shares in issue immediately after completion of the [REDACTED], and assuming that the [REDACTED] is not exercised.

APPENDIX VI

STATUTORY AND GENERAL INFORMATION

- (2) Immediately after completion of the [REDACTED] and assuming the [REDACTED] is not exercised, Dr. Zheng beneficially owns 88,278,594 Domestic Shares of our Company. Dr. Zheng, being the sole general partner, controls Hangzhou Yantai and Hangzhou Hengtai, both of which are Employee Incentive Platforms. Therefore, under the SFO, in addition to his direct shareholding, Dr. Zheng is also deemed to be interested in the 19,031,297 Domestic Shares of our Company through Hangzhou Yantai and the 15,698,265 Domestic Shares of our Company through Hangzhou Hengtai, respectively.
- (3) Suzhou Qiming Ronghe Venture Capital Partnership (Limited Partnership) is managed by Suzhou Qicheng Investment Management Partnership (Limited Partnership) (蘇州啟承投資管理合夥企業(有限合夥)), which is in turn managed by Shanghai Qichang Investment Consulting Co., Ltd. (上海啟昌投資諮詢有限公司), a company held as to 50% by Mr. Hu Xubo, a non-executive Director of our Company. Therefore, Mr. Hu Xubo is deemed to be interested in the interest of Suzhou Qiming Ronghe Venture Capital Partnership (Limited Partnership) under the SFO.

2. Substantial Shareholders

For the information on the persons who will, immediately following the completion of the [REDACTED], have interests or short positions in our Shares or underlying Shares which would be required to be disclosed to our Company and the Hong Kong Stock Exchange under the provisions of Divisions 2 and 3 of Part XV of the SFO, see “Substantial Shareholders.”

So far as set out above, our Directors are not aware of any persons (other than our Directors, Supervisors or chief executive) will, immediately following the completion of the [REDACTED], directly or indirectly, be interested in 10% or more of the nominal value of any class of share capital carrying rights to vote in all circumstances at general meetings of any other member of our Group.

3. Service Contracts

Pursuant to Rules 19A.54 and 19A.55 of the Listing Rules, we have entered into a contract with each of our Directors and Supervisors in respect of, among other things, compliance with the relevant laws and regulations, the Articles of Association and applicable provisions on arbitration.

Our Directors [entered] into service contracts with our Company in [●]. The principal particulars of these service contracts comprise (a) a term of [three] years which is equivalent to the term of the Board; and (b) termination provisions in accordance with their respective terms. Our Directors may be re-appointed subject to Shareholders’ approval. The service contracts can be renewed pursuant to our Articles of Association and applicable rules.

Each of our Supervisors [entered] into a contract with our Company in [●]. Each contract contains provisions relating to compliance with relevant laws and regulations, observation of our Articles of Association and resolution of disputes by means of arbitration.

Save as disclosed above, we have not entered, and do not propose to enter, into any service contracts with any of our Directors or Supervisors in their respective capacities as Directors or Supervisors (other than contracts expiring or determinable by the employer within one year without any payment of compensation (other than statutory compensation)).

APPENDIX VI

STATUTORY AND GENERAL INFORMATION

4. Director’s and Supervisors’ Remuneration

Save as disclosed in “Directors, Supervisors and Senior Management” and “Appendix I—Accountants’ Report—The Group—II Notes to The Historical Financial Information—8. Directors’ and Chief Executive’s Remuneration,” for the two financial years ended December 31, 2019 and 2020, none of our Directors or Supervisors received other remunerations of benefits in kind from us.

5. Employee Incentive Schemes

The following is a summary of the principal terms of the Employee Incentive Schemes dated January 2, 2018 (as amended on September 21, 2020) and December 25, 2019 (as amended on September 21, 2020) respectively (collectively, the “Schemes”). The terms of the Schemes are not subject to the provisions of Chapter 17 of the Listing Rules as the Scheme does not involve the grant of options by our Company after the [REDACTED]. Given the underlying Shares under the Employee Incentive Schemes had already been issued, there will not be any dilution effect to the issued Shares upon the vesting of the Shares under the Employee Incentive Schemes. No further award will be granted after [REDACTED].

As of the Latest Practicable Date, the Company had established two Employee Incentive Platforms, namely Hangzhou Yantai and Hangzhou Hengtai. The two Employee Incentive Platforms, in aggregate, held 34,729,562 Domestic Shares. For the details of the Employee Incentive Platforms, see “History, Development and Corporate Structure—Employee Incentive Schemes.”

Objectives

The purpose of the Schemes is to build an incentive mechanism for the management members and core employees of our Company, attracting talents in the labour market to raise the core competitiveness of our Company. The Scheme also serves the purpose of achieving efficient and high-quality management of our Company.

Eligibility

Pursuant to the scheme documents (the “Scheme Documents”), participants of the Schemes include our Company’s senior management members and core employees. The Scheme Documents further provided that the following employees may not be selected as participants to the Schemes (as applicable):

- Employees who have received public censure from any stock exchange or have been declared as disqualified persons for the preceding three years;
- Employees who have received administrative penalties from CSRC due to material violation laws and regulations for the preceding three years;

APPENDIX VI STATUTORY AND GENERAL INFORMATION

- Employees who are forbidden to hold the position of director or senior management pursuant to the PRC Company Law; or
- Employees who are otherwise not eligible due to serious violations of laws, regulations and the policies of the Company as determined by the Board.

Grant of Award

The sole general partner of Hangzhou Yantai and Hangzhou Hengtai is Dr. Zheng and in effect, all management powers and voting rights of the Employee Incentive Platforms reside with the sole general partner, Dr. Zheng.

All selected participants do not have any voting rights in our Company. The selected participants will be granted awards in the form of economic interest in the Employee Incentive Platforms as a limited partner of the relevant Employee Incentive Platform. Upon becoming the limited partner of the Employee Incentive Platforms, the selected participants indirectly receive economic interest in the corresponding number of underlying Shares held by the Employee Incentive Platforms.

Administration of the Schemes

Our Board retain full discretion over the following matters of the Schemes:

- the selection of participants in the Schemes, which currently include Directors, core employees and senior management members of our Group; and
- the implementation, amendment and termination of the Schemes.

6. Disclaimers

Saved as disclosed in this Document:

- (a) none of our Directors, Supervisors or any of the parties listed in "Qualification of Experts" of this Appendix is:
 - (i) interested in our promotion, or in any assets which, within the two years immediately preceding the date of this Document, have been acquired or disposed of by or leased to us, or are proposed to be acquired or disposed of by or leased to our Company;

APPENDIX VI STATUTORY AND GENERAL INFORMATION

- (ii) materially interested in any contract or arrangement subsisting at the date of this Document which is significant in relation to our business;
- (b) save in connection with the [REDACTED] and the [REDACTED], none of the parties listed in “Qualification of Experts” of this Appendix:
 - (i) is interested legally or beneficially in any shares in any member of our Group; or
 - (ii) has any right (whether legally enforceable or not) to subscribe for or to nominate persons to subscribe for any securities in any member of our Group;
- (c) none of our Directors or Supervisors or their close associates or any shareholders of our Company who to the knowledge of our Directors owns more than 5% of our issued share capital has any interest in our top five customers or suppliers; and
- (d) none of our Directors or Supervisors is a director or employee of a company that has an interest in the share capital of our Company which, once the H Shares are [REDACTED] on the Hong Kong Stock Exchange, would have to be disclosed pursuant to Divisions 2 and 3 of Part XV of the SFO.

OTHER INFORMATION

Estate Duty

Our Directors have been advised that no material liability for estate duty is likely to impose on our Company or our subsidiary.

Litigation

As of the Latest Practicable Date, no member of our Group was involved in any litigation, arbitration, administrative proceedings or claims of material importance, and, so far as we are aware, no litigation, arbitration, administrative proceedings or claims of material importance are pending or threatened against any member of our Group.

APPENDIX VI

STATUTORY AND GENERAL INFORMATION

Joint Sponsors

The Joint Sponsors have made an application on our behalf to the Listing Committee for the [REDACTED] of, and permission to deal in, our H Shares. All necessary arrangements have been made to enable the securities to be admitted into CCASS.

The Joint Sponsors satisfy the independence criteria applicable to sponsors set out in Rule 3A.07 of the Listing Rules. Each of the Joint Sponsors will receive a fee of US\$500,000 for acting as a sponsor for the [REDACTED].

Preliminary Expenses

Our Company did not incur any material preliminary expenses.

Qualification of Experts

The qualifications of the experts who have given opinions or advice in this Document are as follows:

Name	Qualification
Goldman Sachs (Asia) L.L.C.	Licensed to conduct Type 1 (dealing in securities), Type 4 (advising on securities), Type 5 (advising on futures contracts), Type 6 (advising on corporate finance) and Type 9 (asset management) of regulated activities as defined under the SFO
China International Capital Corporation Hong Kong Securities Limited	Licensed to conduct Type 1 (dealing in securities), Type 2 (dealing in futures contracts), Type 4 (advising on securities), Type 5 (advising on futures contracts) and Type 6 (advising on corporate finance) of regulated activities under the SFO
Ernst & Young	Certified Public Accountants and Registered Public Interest Entity Auditor
Llinks Law Offices	PRC legal advisor
China Insights Industry Consultancy Limited	Independent industry consultant

Consents of Experts

Each of the experts referred to in “Qualification of Experts” in this Appendix has given and has not withdrawn its respective written consents to the issue of this Document with the inclusion of certificates, letters, opinions or reports and the references to its names included herein in the form and context in which it is respectively included.

APPENDIX VI

STATUTORY AND GENERAL INFORMATION

None of the experts named above has any of our shareholding interests or rights (whether legally enforceable or not) or any of our members to subscribe for or to nominate persons to subscribe for our securities or any of our member.

Compliance Advisor

We have appointed Orient Capital (Hong Kong) Limited as our Compliance Advisor upon the [REDACTED] in compliance with Rule 3A.19 of the Hong Kong Listing Rules.

Taxation of Holders of H Shares

The sale, purchase and transfer of H Shares are subject to Hong Kong stamp duty. The current rate charged on each of the seller and purchaser is HK\$1.00 for every HK\$1,000 (or part thereof) of the consideration or, if higher, the fair value of the H Shares being sold or transferred. For further information in relation to taxation, see “Appendix III—Taxation and Foreign Exchange—Taxation in Hong Kong.”

No Material Adverse Change

Save as disclosed in the “Summary—Recent Development and No Material Adverse Change” and “Financial Information—No Material Adverse Change” to this Document, after all due diligence was performed as appropriate as the Directors believe, our Directors confirm that, as of the date of this Document, there has been no material adverse change in our financial position or prospects since December 31, 2020 and there has been no event that materially and adversely affected the data set out in the accountants’ reports in Appendix I to this Document since December 31, 2020.

Binding Effect

This Document shall have the effect, if any application is made pursuant hereto, of rendering all persons concerned bound by all the provisions (other than the penal provisions) of sections 44A and 44B of the Companies (Winding Up and Miscellaneous Provisions) Ordinance so far as applicable.

Miscellaneous

Save as disclosed in this Document:

- (a) within the two years preceding the date of this Document: (i) we have not issued nor agreed to issue any share or loan capital fully or partly paid either for cash or for a consideration other than cash; and (ii) no commissions, discounts, brokerage fee or other special terms have been granted in connection with the issue or sale of any shares of our Company;
- (b) no share or loan capital of our Company is under option or is agreed conditionally or unconditionally to be put under option;

APPENDIX VI **STATUTORY AND GENERAL INFORMATION**

- (c) we have not issued nor agreed to issue any founder shares, management shares or deferred shares;
- (d) there are no arrangements under which future dividends are waived or agreed to be waived;
- (e) there are no procedures for the exercise of any right of pre-emption or transferability of subscription rights;
- (f) there are no contracts for hire or hire purchase of plant to or by us for a period of over one year which are substantial in relation to our business;
- (g) there have been no interruptions in our business which may have or have had a significant effect on our financial position in the last 12 months;
- (h) there are no restrictions affecting the remittance of profits or repatriation of capital by us into Hong Kong from outside Hong Kong;
- (i) no part of the equity or debt securities of our Company, if any, is currently listed on or dealt in on any stock exchange or trading system, and no such listing or permission to list on any stock exchange other than the Hong Kong Stock Exchange is currently being or agreed to be sought;
- (j) our Company has no outstanding convertible debt securities or debentures;
- (k) our Company is a joint stock limited company and is subject to the PRC Company Law; and
- (l) our Company has adopted a code of conduct regarding Directors’ and Supervisors’ securities transactions on terms as required under the Model Code for Securities Transactions by Directors of Listed Issuers as set out in Appendix 10 to the Hong Kong Listing Rules.

Restrictions on Share Repurchases

For details, see “Appendix IV—Summary of Principal Legal and Regulatory Provisions” and “Appendix V—Summary of Articles of Association.”

Bilingual Document

The English language and Chinese language versions of this Document are being published separately, in reliance upon the exemption provided by section 4 of the Companies Ordinance (Exemption of Companies and Prospectuses from Compliance with Provisions) Notice (Chapter 32L of the Laws of Hong Kong).

APPENDIX VI

STATUTORY AND GENERAL INFORMATION

Promoters

The promoters of our Company are all of the 21 then shareholders of our Company as at September 30, 2020 before our conversion into a joint stock limited liability company. Save as disclosed in this Document, within the two years immediately preceding the date of this Document, no cash, securities or benefit has been paid, allotted or given, or is proposed to be paid, allotted or given to the promoters named above in connection with the [REDACTED] or the related transactions described in this Document.

APPENDIX VII

**DOCUMENTS DELIVERED TO THE REGISTRAR OF
COMPANIES AND AVAILABLE FOR INSPECTION**

7. the legal opinions issued by Llinks Law Offices, our PRC Legal Advisor, in respect of, among other things, the general matters and property interests of our Group under PRC law;
8. the industry report issued by CIC; and
9. a copy of the following PRC laws, together with unofficial English translations:
 - (i) the PRC Company Law;
 - (ii) the PRC Securities Law;
 - (iii) the Mandatory Provisions; and
 - (iv) the Special Regulations.