





HISTORY, DEVELOPMENT AND REORGANISATION

OVERVIEW

Our Group’s history can be traced back to the 1970s when TO Soon, the late father of Soon Siblings, conducted trading of sundry goods under “Swang Chai Chuan” in Kuantan. In 1982, TO Soon established Swang Chai Chuan as a sole proprietorship for distribution and sales of groceries in Peninsular Malaysia. As the business continued to grow, TO Soon, SB Soon and LS Soon established SCCSB, our major subsidiary engaged in distribution of F&B products in Peninsular Malaysia, in March 1995 for taking up and expanding the business of Swang Chai Chuan.

Since then, our business continued to grow as the Soon Family decided to expand its business into the distribution and sales of F&B products for recognised international and domestic Third-Party Brand or under our Own Brands. Over the years, we have become a well-established F&B distributor in Malaysia, offering a wide range of quality F&B products that can be broadly categorised into (i) dairy products, (ii) frozen food, (iii) packaged food and commodities, (iv) sauce, oil and condiments, (v) beverages and (vi) specialty products, complemented by other non-F&B products, including (i) personal and baby care products, (ii) pet care products and (iii) cleaning and kitchen supplies. Our customers mainly include (i) hypermarkets and supermarket chains; (ii) provision shops; (iii) convenience stores and kiosks; (iv) F&B dealers and merchandisers; (v) HORECA; and (vi) school canteens, where our products are available for sale to end consumers.

In 2007, we started tapping into the development of certain products under our Own Brands, and since then our Own-Brand Product range has been extended to include dairy products, specialty products, pet care products and frozen food under our major brands of *CED* , *Mega Fresh* , *Mega Food* , *Sayangku*  and *Snowcat* .

In order to distribute our products and to serve our customers in different regions in Malaysia, as at 31 December 2021, we had a fleet of more than 140 self-operated logistics vehicles, of which approximately 100 are refrigerated vehicles for storage of frozen food and dairy products and we operated eight self-owned and four leased warehouses strategically located in Eastern Peninsular Malaysia (including Kuantan, Mentakab, Kuala Terengganu, Kota Bharu), Western Peninsular Malaysia (including Puchong, Seremban), Southern Peninsular Malaysia (including Johor Bahru) and Northern Peninsular Malaysia (including Perai, Alor Setar) with an aggregate designated storage capacity of approximately 25,600 CBM, of which nine warehouses were equipped with cold storage facilities.



HISTORY, DEVELOPMENT AND REORGANISATION

Key milestones of our Group

The chronological overview of the key events in respect of the major business development of our Group is set out below:

<u>Year</u>	<u>Events</u>
1982	– Established Swang Chai Chuan as a sole proprietorship business mainly engaged in distribution and sales of groceries in Peninsular Malaysia
1988	– Set up our cold room in Kuantan for storage of meat and seafood products
1989	– Commenced our own logistic and transportation services
1994	– We were appointed as a distributor of a subsidiary of an international dairy company listed on the New Zealand Exchange to sell and market its branded dairy products in Eastern Peninsular Malaysia
1995	– SCCSB, our first operating subsidiary, was incorporated in Malaysia to take up and expand the business of Swang Chai Chuan
2004	– We were appointed as a distributor for a well-known global ice cream brand to sell and market its branded products in Klang Valley in Western Peninsular Malaysia
2006	– Established our first self-owned warehouse in Kuala Terengganu
2007	– Acquired as our first Own Brands, namely “ <i>CED</i> ”, to provide specialty products, and “ <i>Mega</i> ” (which was later rebranded as “ <i>Mega Fresh</i> ”), as our Own Brand to provide frozen food such as french fries and chicken nuggets
2011	– Established our headquarters with warehouse in Kuantan
2014	– Expanded our business in Southern Peninsular Malaysia and established our self-owned warehouse in Johor Bahru

HISTORY, DEVELOPMENT AND REORGANISATION

<u>Year</u>	<u>Events</u>
2017	<ul style="list-style-type: none">– Expanded our business in Northern Peninsular Malaysia when we were appointed as a local distributor for <i>Mondelez</i>, a company which manufactures and markets snacks and confectionery, whose parent company is a multinational corporation based in the United States with a portfolio of popular brands of chocolate, cookies, biscuits, gum, confectionery and powdered beverages across the globe
2018	<ul style="list-style-type: none">– Acquired “<i>Sayangku</i>”  and established “<i>Snowcat</i>” SNOWCAT as our own pet care brands
2019	<ul style="list-style-type: none">– Established our Own Brand, “<i>Mega Food</i>” , to provide dairy products– We were appointed as a distributor for a company which manufactures and markets food spreads, whose parent company is based in the Netherlands and is a producer of plant-based spreads globally
2020	<ul style="list-style-type: none">– Expanded our distribution and sales network by leasing two warehouses in Kuantan and Perai to satisfy the increasing demand in F&B products due to the COVID-19 pandemic– We were appointed as a distributor for a multinational manufacturer of household insecticides originated from Japan

OUR CORPORATE DEVELOPMENT

Our Company was incorporated in the Cayman Islands as an exempted company with limited liability under the Companies Act on 14 February 2019 and is the holding company of our Group. As at the Latest Practicable Date, the subsidiaries of our Group comprised SCC Holdings, SCC Holding Malaysia, SCC HK, SCCSB, SCC Seafood, SCCM Pahang, SCCM East Coast, SCCM, Chop Chin Huat and SCC Logistics. Details of these subsidiaries and the corporate structure of our Group are set out in the sub-section headed “Establishment and development of the subsidiaries of our Company” in this section.

Prior to the [REDACTED], our Group underwent the Reorganisation and immediately following the completion of the Reorganisation, the entire issued share capital of our Company was owned by Soon Holdings, a company incorporated in the BVI which is owned as to 70% by SB Soon and 10% by each of LS Soon, SL Soon and CA Soon.

HISTORY, DEVELOPMENT AND REORGANISATION

Immediately following completion of the Capitalisation Issue and the [REDACTED], Soon Holdings will in aggregate own [REDACTED]% of the issued share capital of our Company (without taking into account any Shares which may be allotted and issued upon the exercise of the [REDACTED] or any options that may be granted under the Share Option Scheme).

Establishment and development of the subsidiaries of our Company

Our Company was incorporated in the Cayman Islands under the Companies Act on 14 February 2019 in preparation for the [REDACTED] and is the holding company of our Group. Our Company has been registered as a non-Hong Kong company under Part 16 of the Companies Ordinance on 3 February 2021. As at the date of incorporation, our Company had an authorised share capital of HK\$380,000 divided into 38,000,000 Shares of par value of HK\$0.01 each, of which one Share was allotted and issued as fully paid to an independent initial subscriber at par. On the same day, such Share was transferred to Soon Holdings at par. For further details of the Reorganisation, please refer to the paragraph headed “Reorganisation” in this section below.

As at the Latest Practicable Date, our Group mainly comprised our Company and ten subsidiaries. Set out below is the brief corporate history of the subsidiaries of our Company.

(1) SCC Holdings

SCC Holdings was incorporated in the BVI with limited liability on 27 December 2018 and was authorised to issue a maximum of 50,000 shares of a single class each with a par value of US\$1.00. On the same date, SCC Holdings allotted and issued as fully paid one share to Soon Holdings.

Upon completion of the Reorganisation, SCC Holdings became the direct wholly-owned subsidiary of our Company and an intermediate holding company of our Group. For further details, please refer to the paragraph headed “Reorganisation” in this section below.

As at the Latest Practicable Date, SCC Holdings was an investment holding company.

(2) SCC Holding Malaysia

SCC Holding Malaysia was incorporated in Malaysia with limited liability on 17 December 2018 with an issued and paid-up capital of RM100 divided into 100 shares of RM1.00 each. As at the date of incorporation, 70 shares of SCC Holding Malaysia were allotted and issued as fully paid to SB Soon and 10 shares were allotted and issued as fully paid to each of SL Soon, CA Soon and LS Soon.

Upon completion of the Reorganisation, SCC Holding Malaysia became the wholly-owned subsidiary of SCC Holdings, and an intermediate holding company of our Group. For further details, please refer to the paragraph headed “Reorganisation” in this section below.

As at the Latest Practicable Date, SCC Holding Malaysia was an investment holding company.

HISTORY, DEVELOPMENT AND REORGANISATION

(3) SCC HK

SCC HK was incorporated in Hong Kong with limited liability on 29 January 2019. As at the date of incorporation, SCC HK allotted and issued as fully paid one share (representing the entire issued share capital of SCC HK) to SCC Holdings. The shareholding structure of SCC HK remained unchanged thereafter.

Since its incorporation and up to the Latest Practicable Date, SCC HK was mainly incorporated to establish a presence in Hong Kong and has not commenced any business activities.

(4) SCCSB

SCCSB was incorporated in Malaysia with limited liability on 28 March 1995, with an authorised share capital of RM500,000 divided into 500,000 shares of RM1.00 each. As at the date of incorporation, one share was allotted and issued at par to each of SB Soon, LS Soon and TO Soon. After the said allotments, SCCSB was owned as to approximately 33.33% by each of SB Soon, LS Soon and TO Soon, respectively.

On 11 June 1997, SCCSB allotted and issued at par 374,999 shares, 74,999 shares and 49,999 shares to TO Soon, SB Soon and LS Soon, respectively. After the said allotments, SCCSB was owned as to 75%, 15% and 10% by TO Soon, SB Soon and LS Soon, respectively.

On 19 February 1998, TO Soon transferred 125,000 shares of SCCSB to CH Tan at par. After the said transfer, SCCSB was owned as to 50%, 25%, 15% and 10% by TO Soon, CH Tan, SB Soon and LS Soon, respectively.

Between 2002 and 2010, there were various transfers and allotments of shares and the authorised share capital of SCCSB was increased. As at 18 February 2010, SCCSB was owned as to 52%, 25%, 13% and 10% by SB Soon, CH Tan, CA Soon and LS Soon, respectively. The shareholding structure of SCCSB remained unchanged until immediately prior to the Reorganisation.

Upon completion of the Reorganisation, SCCSB became wholly owned by SCC Holding Malaysia and an indirect wholly-owned subsidiary of our Company. For further details, please refer to the paragraph headed “Reorganisation” in this section below.

During the Track Record Period and up to the Latest Practicable Date, SCCSB mainly engaged in the distribution of F&B products in Malaysia.

HISTORY, DEVELOPMENT AND REORGANISATION

(5) SCC Seafood

SCC Seafood was incorporated in Malaysia with limited liability on 26 October 1998, with an authorised capital of RM100,000 divided into 100,000 shares of RM1.00 each. As at the date of incorporation, one share of SCC Seafood was allotted and issued at par to each of the two Independent Third Parties.

On 23 November 1999, TO Soon and SB Soon acquired at par one share each from the two Independent Third Parties. After the said transfers, SCC Seafood was owned as to 50% by TO Soon and 50% by SB Soon.

On 21 January 2002, the authorised share capital of SCC Seafood was increased from RM100,000 to RM500,000 by the creation of 400,000 ordinary shares of RM1.00 each. On the same date, SCC Seafood allotted and issued as fully paid at par 99,999 shares, 59,999 shares and 40,000 shares to TO Soon, SB Soon and SL Soon, respectively. After the said allotments, SCC Seafood was owned as to 50%, 30% and 20% by TO Soon, SB Soon and SL Soon, respectively.

Between 2002 and 2010, there were various transfers and allotments of shares and the authorised share capital of SCC Seafood was increased. As at 16 March 2010, SCC Seafood was owned as to 52%, 30%, 9% and 9% by SB Soon, SL Soon, LS Soon and CA Soon, respectively. The shareholding structure of SCC Seafood remained unchanged until immediately prior to the Reorganisation.

Upon completion of the Reorganisation, SCC Seafood became wholly owned by SCC Holding Malaysia and an indirect wholly-owned subsidiary of our Company. For further details, please refer to the paragraph headed "Reorganisation" in this section below.

During the Track Record Period and up to the Latest Practicable Date, SCC Seafood mainly engaged in the distribution and sales of frozen seafood and meat products in Malaysia.

(6) SCCM Pahang

SCCM Pahang was incorporated in Malaysia with limited liability on 18 June 1996, with an authorised capital of RM100,000 divided into 100,000 shares of RM1.00 each. As at the date of incorporation, one share was allotted and issued at par to each of SB Soon and three Independent Third Parties, respectively. After the said allotments, SCCM Pahang was owned as to 25% by each of SB Soon and three Independent Third Parties, respectively.

Between 1996 and 2002, there were various transfers and allotments and the authorised share capital of SCCM Pahang was increased. As at 21 January 2002, SCCM Pahang was owned as to 50% by TO Soon and 50% by SB Soon. On 7 March 2002, TO Soon transferred (i) 4,000 shares to SB Soon at the consideration of RM1.00; (ii) 78,001 shares to CA Soon at

HISTORY, DEVELOPMENT AND REORGANISATION

the consideration of RM1.00; and (iii) 18,000 shares to SL Soon at the consideration of RM1.00. After the said transfers, SCCM Pahang was owned as to approximately 52%, 39% and 9% by SB Soon, CA Soon and SL Soon, respectively.

On 12 August 2002, SCCM Pahang further allotted and issued as fully paid at par 155,999 shares 116,999 shares and 27,000 shares to SB Soon, CA Soon and SL Soon, respectively. After the said allotments, SCCM Pahang was owned as to 52%, 39% and 9% by SB Soon, CA Soon and SL Soon, respectively. The shareholding structure of SCCM Pahang remained unchanged until immediately prior to the Reorganisation.

Upon completion of the Reorganisation, SCCM Pahang became wholly owned by SCC Holding Malaysia and an indirect wholly-owned subsidiary of our Company. For further details, please refer to the paragraph headed “Reorganisation” in this section below.

During the Track Record Period and up to the Latest Practicable Date, SCCM Pahang mainly engaged in the distribution of FMCGs in the East Coast of Peninsular Malaysia.

(7) SCCM East Coast

SCCM East Coast was incorporated in Malaysia with limited liability on 14 August 2000, with an authorised capital of RM100,000 divided into 100,000 shares of RM1.00 each. As at the date of incorporation, one share was allotted and issued at par to each of SB Soon and TO Soon. After the said allotments, SCCM East Coast was owned as to 50% by TO Soon and 50% by SB Soon.

On 7 March 2002, TO Soon transferred one share of SCCM East Coast to CA Soon at par. After the said transfer, SCCM East Coast was owned as to 50% by SB Soon and 50% by CA Soon.

On 14 November 2003, SCCM East Coast allotted and issued as fully paid at par 4,999 shares to each of SB Soon and CA Soon. After the said allotments, SCCM East Coast was owned as to 50% by SB Soon and 50% by CA Soon.

On 30 September 2005, SCCM East Coast further allotted and issued for cash as fully paid at par 20,000 shares to each of SB Soon and CA Soon. After the said allotments, SCCM East Coast was owned as to 50% by SB Soon and 50% by CA Soon. The shareholding structure of SCCM East Coast remained unchanged until immediately prior to the Reorganisation.

Upon completion of the Reorganisation, SCCM East Coast became wholly owned by SCC Holding Malaysia and an indirect wholly-owned subsidiary of our Company. For further details, please refer to the paragraph headed “Reorganisation” in this section below.

During the Track Record Period and up to the Latest Practicable Date, SCCM East Coast mainly engaged in the marketing and distribution of F&B products in the East Coast of Peninsular Malaysia.

HISTORY, DEVELOPMENT AND REORGANISATION

(8) SCCM

SCCM was incorporated in Malaysia with limited liability on 10 November 2003 with an authorised capital of RM100,000 divided into 100,000 Shares of RM1.00 each. On the same date, one share was allotted and issued at par to each of SB Soon and CA Soon. After the said allotments, SCCM was owned as to 50% by SB Soon and 50% by CA Soon.

Between 2003 and 2010, there were various allotment of shares and the authorised share capital of SCCM was increased. As at 18 February 2010, SCCM was owned as to 51% by SB Soon and 49% by CA Soon.

On 29 August 2014, CA Soon transferred 190,000 shares of SCCM to SB Soon at par. After the said transfer, SCCM was owned as to 70% by SB Soon and 30% by CA Soon. The shareholding structure of SCCM remained unchanged until immediately prior to the Reorganisation.

Upon completion of the Reorganisation, SCCM became wholly owned by SCC Holding Malaysia and an indirect wholly-owned subsidiary of our Company. For further details, please refer to the paragraph headed "Reorganisation" in this section below.

Since its incorporation and up to the Latest Practicable Date, SCCM mainly engaged in the packaging, processing, marketing and distribution of F&B products in Malaysia.

(9) Chop Chin Huat

Chop Chin Huat was incorporated in Malaysia with limited liability on 12 January 1989, with an authorised share capital of RM100,000 divided into 100,000 shares of RM1.00 each. As at the date of incorporation, Chop Chin Huat was owned in equal shares by two Independent Third Parties.

Between 1989 and 2009, there were various transfers and allotments of shares and the authorised share capital of Chop Chin Huat was increased. On 10 April 2017, SB Soon acquired 250,000 shares from an Independent Third Party at the consideration of RM927,500. The consideration was determined with reference to the financial position and business prospect of Chop Chin Huat at the time. On the same day, ML Ng, the spouse of SB Soon, acquired 90,000 shares from an Independent Third Party at the consideration of RM333,900. The consideration was determined with reference to the financial position and business prospect of Chop Chin Huat at the time. After the said transfers, Chop Chin Huat was owned as to 50%, 32% and 18% by SB Soon, an Independent Third Party and ML Ng, respectively.

On 15 January 2018, SB Soon acquired 160,000 shares of Chop Chin Huat from an Independent Third Party at the consideration of RM593,600. The consideration was determined with reference to the financial position and business prospect of Chop Chin Huat at the time.

HISTORY, DEVELOPMENT AND REORGANISATION

After the said transfer, Chop Chin Huat was owned as to 82% and 18% by SB Soon and ML Ng, respectively. The shareholding structure of Chop Chin Huat remained unchanged until immediately prior to the Reorganisation.

Upon completion of the Reorganisation, Chop Chin Huat became wholly owned by SCC Holding Malaysia and an indirect wholly-owned subsidiary of our Company. For further details, please refer to the paragraph headed “Reorganisation” in this section below.

Since its incorporation and up to the Latest Practicable Date, Chop Chin Huat mainly engaged in the distribution of F&B products in the Northern Peninsular Malaysia.

(10) SCC Logistics

SCC Logistics was incorporated in Malaysia with limited liability on 14 January 2013, with an authorised share capital of RM5,000,000 divided into 5,000,000 shares of RM1.00 each. As at the date of incorporation, one share was allotted and issued at par to each of the Soon Brothers. After the said allotments, SCC Logistics was owned as to approximately 33.33% by each of the Soon Brothers.

On 15 May 2013, SCC Logistics allotted and issued for cash as fully paid at par 259,999 shares, 149,999 shares and 89,999 shares to SB Soon, SL Soon and CA Soon, respectively. After the said allotments, SCC Logistics was owned as to 52%, 30% and 18% by SB Soon, SL Soon and CA Soon, respectively.

On 11 July 2017, (i) SB Soon transferred 260,000 shares to Ms. Yap Shing Shya (“**Ms. Yap**”), who is an employee of the Group, at par; (ii) SL Soon transferred 150,000 shares to Mr. Sang Pri Bin Ahmad (“**Mr. Sang**”) who was an employee of the Group at the material time, at par; and (iii) CA Soon transferred 50,000 shares to Mr. Sang and 40,000 shares to Ms. Yap at par. After the said transfers, SCC Logistics was owned as to 60% by Ms. Yap and 40% by Mr. Sang.

Pursuant to the confirmatory deeds executed by Ms. Yap and Mr. Sang on 4 February 2021, Ms. Yap and Mr. Sang confirmed that they held the 300,000 shares and 200,000 shares, respectively, on trust for and on behalf of SB Soon, CA Soon and SL Soon (as the case may be). The reason for the trust arrangement was that at the material time, there was a significant growth in the distribution and sales business of our Group in general and the Soon Siblings hence intended to devote more of their time in and focus their managerial effort on this major business segment with business strategies focusing on the expansion of sales and distribution network and product portfolio, instead of the provision of logistics services mainly engaged by SCC Logistics. In particular, it was considered that the trust arrangement could allow us to (i) streamline our corporate structure to include only the subsidiaries engaged in the core business within our Group; (ii) streamline the operating layers and procedures and line of report whereby the daily operations and decision making of SCC Logistics could be handled by Ms. Yap and Mr. Sang without causing material disruption or delay on the core business of our Group; and (iii) with the benefit of the above, enhance operational and management efficiency,

HISTORY, DEVELOPMENT AND REORGANISATION

and thus achieve operational and administrative cost saving and improve quality of services. To align with the Soon Siblings’ focus on distribution and sales business, SB Soon, CA Soon and SL Soon decided to register their relevant shareholdings in SCC Logistics in the name of Ms. Yap and Mr. Sang who, at the material time, had been working in the Group for approximately seven years and 16 years respectively. Ms. Yap and Mr. Sang were also nominated by SB Soon, CA Soon and SL Soon (as the case may be) to be the directors of SCC Logistics in order to give them apparent authority to handle day-to-day operations and administration of SCC Logistics. SB Soon, CA Soon and SL Soon remained as the beneficial owners of SCC Logistics who gave directions and instructions to Ms. Yap and Mr. Sang throughout the trust period. As such, there had not been any change in management and control of SCC Logistics during such period.

This trust arrangement was originally intended to be a trial attempt. Under such arrangement, the Soon Siblings would assess (i) the performance of SCC Logistics when it was not held under their names; and (ii) the feasibility of its cooperation with the Group under the operation of Ms. Yap and Mr. Sang. The shares of SCC Logistics were transferred to Ms. Yap and Mr. Sang with an intention at that time to promote their loyalty to our Group as senior employees, and to encourage Ms. Yap and Mr. Sang to devote more time and attention to the business of SCC Logistics. The Soon Siblings expected to transfer SCC Logistics to Ms. Yap and Mr. Sang on a long-term basis if they could fulfill the performance requirements and achieve a smooth transition while maintaining business cooperation with the Group. Nevertheless, having considered the possibility of the [REDACTED], SB Soon, CA Soon and SL Soon (as the case may be) instructed Ms. Yap and Mr. Sang to transfer the said shares held by them to SCC Holding Malaysia (at the direction of SB Soon, CA Soon and SL Soon (as the case may be)) on 26 December 2018, each at the nominal consideration of RM1.00, as part of the Reorganisation. Upon completion of the Reorganisation, SCC Logistics became wholly owned by SCC Holding Malaysia and an indirect wholly-owned subsidiary of our Company. For further details, please refer to the paragraph headed “Reorganisation” in this section below.

During the Track Record Period and up to the Latest Practicable Date, SCC Logistics mainly engaged in the provision of cold room facilities and transportation services in the East Coast of Peninsular Malaysia.

DISPOSAL OF SUBSIDIARIES

With a view to streamlining our operations and to focusing on our core business, we have made the following disposals.

NSB Marketing

NSB Marketing was incorporated in Malaysia with limited liability on 29 September 2015 and became a wholly-owned subsidiary of SCC Holding Malaysia on 26 December 2018.

HISTORY, DEVELOPMENT AND REORGANISATION

NSB Marketing mainly engaged in distribution and sales of milk powder of a particular brand in Malaysia and had commenced operation since the year of its incorporation. As confirmed by our Directors, it had ceased operation since October 2017 (before the beginning of the Track Record Period) since the distributorship in relation to that particular brand ended upon mutual agreement. For the years ended 31 December 2018, 2019 and 2020, NSB Marketing recorded a revenue of nil, nil and nil, respectively; and a net loss after taxation of approximately RM0.03 million, RM0.004 million and RM0.01 million, respectively. As at 31 December 2018, 2019 and 2020, NSB Marketing’s net assets amounted to approximately RM1.7 million, RM1.7 million and RM1.7 million, respectively. However, as NSB Marketing had ceased operation, the Controlling Shareholders therefore decided to dispose of NSB Marketing from our Group. As a result, SCC Holding Malaysia disposed of the entire equity interest of NSB Marketing to SB Soon at the nominal consideration of RM100 on 31 December 2020 on the basis that NSB Marketing has ceased operation and as deemed distribution arising from Reorganisation prior to the [REDACTED]. Our Directors confirmed that NSB Marketing was solvent prior to the time of the disposal. As confirmed by our Directors and our Malaysia Legal Advisers, NSB Marketing had not been involved in any material legal and regulatory non-compliant incidents, regulatory enquiries, claims, litigation or legal proceedings (whether actual or threatened) during the Track Record Period up to the date of its disposal. After the disposal and as at the Latest Practicable Date, our Group ceased to have any interest in NSB Marketing.

EC Maju Frozen

EC Maju Frozen was incorporated in Malaysia with limited liability on 2 March 2012 and became a wholly-owned subsidiary of SCC Holding Malaysia on 26 December 2018.

EC Maju Frozen mainly engaged in the business as dealers and retailers in the supply chain of FMCGs in Malaysia and had commenced operation since the year of its incorporation. For the years ended 31 December 2018, 2019 and 2020, EC Maju Frozen recorded a revenue of approximately RM12.5 million, RM9.1 million and RM5.2 million, respectively; and a net profit after taxation of approximately RM0.4 million, net loss after taxation of approximately RM0.05 million and net profit after taxation of approximately RM0.04 million, respectively. As at 31 December 2018, 2019 and 2020, EC Maju Frozen’s net assets amounted to approximately RM0.5 million, RM0.5 million and RM0.5 million, respectively. However, the Controlling Shareholders were of the opinion that it was more beneficial to focus their financial resources on the distribution and sales business in Malaysia, and therefore decided to dispose of EC Maju Frozen. As a result, SCC Holding Malaysia disposed of the entire equity interest of EC Maju Frozen to an Independent Third Party at the consideration of RM400,000 on 31 December 2020. The consideration represented approximately 19% discount of the net asset value of EC Maju Frozen of approximately RM494,000 as at 31 December 2019 and had been arrived at by the parties after arm’s length negotiation, taking into account the profitability and the business prospect of EC Maju Frozen, in particular the loss of approximately RM0.02 million in FY2019 (based on its local audited report for FY2019) and its negative performance around 2020. The said discount of approximately 19% was equivalent to not more than approximately RM100,000 in absolute dollar amount only or 0.005% of the Group’s net profit

HISTORY, DEVELOPMENT AND REORGANISATION

in FY2020. In view of the aforesaid basis for determining the consideration for the disposal and the immaterial discount in absolute dollar amount, our Directors are of the view that the consideration for the disposal determined was in the best interests of the Shareholders and our Group as a whole. Our Directors confirmed that EC Maju Frozen was solvent prior to the time of the disposal. As confirmed by our Directors and our Malaysian Legal Advisers, EC Maju Frozen had not been involved in any material legal and regulatory non-compliant incidents, regulatory enquiries, claims, litigation or legal proceedings (whether actual or threatened) during the Track Record Period up to the date of its disposal. After the disposal and as at the Latest Practicable Date, our Group ceased to have any interest in EC Maju Frozen.

REORGANISATION

The following chart sets out the shareholding structure of our Group since the beginning of the Track Record Period up to immediately before our Reorganisation:

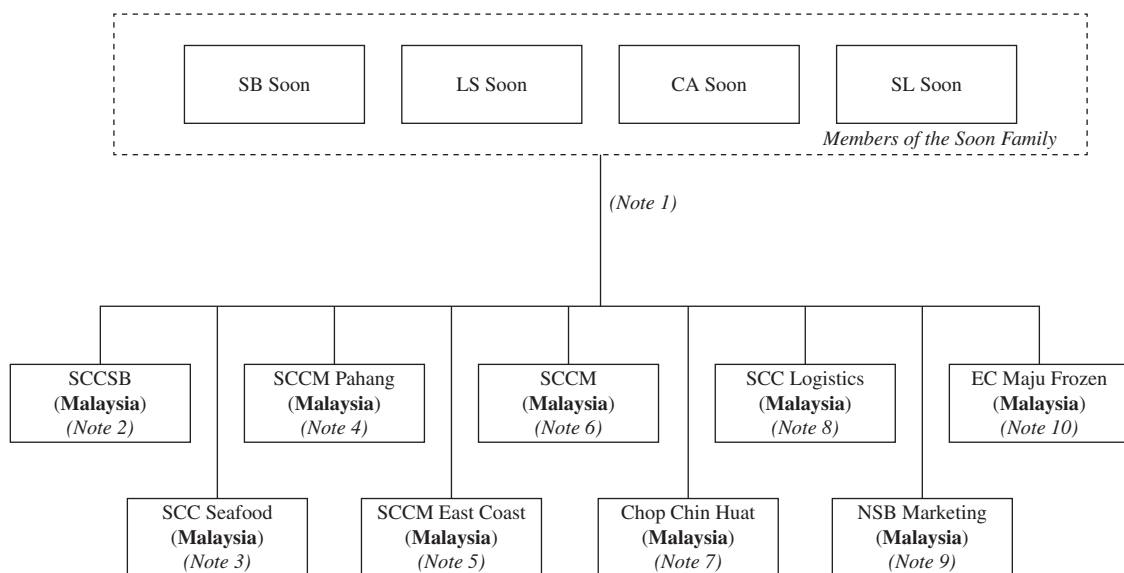

Notes:

- (1) SCCSB, SCC Seafood, SCCM Pahang, SCCM East Coast, SCCM, Chop Chin Huat, SCC Logistics, NSB Marketing and EC Maju Frozen had been held by any or all of SB Soon, CA Soon, LS Soon and SL Soon, each of them being a member of the Soon Family, since the beginning of the Track Record Period and/or up to immediately before our Reorganisation as to the percentages as described in the notes below.
- (2) Since the beginning of the Track Record Period and up to immediately before Reorganisation, SCCSB was owned as to 52%, 13%, 10% and 25% by SB Soon, CA Soon, LS Soon and CH Tan, respectively.
- (3) Since the beginning of the Track Record Period and up to immediately before Reorganisation, SCC Seafood was owned as to 52%, 30%, 9% and 9% by SB Soon, SL Soon, LS Soon and CA Soon, respectively.
- (4) Since the beginning of the Track Record Period and up to immediately before Reorganisation, SCCM Pahang was owned as to 52%, 39% and 9% by SB Soon, CA Soon and SL Soon, respectively.
- (5) Since the beginning of the Track Record Period and up to immediately before Reorganisation, SCCM East Coast was owned as to 50% and 50% by SB Soon and CA Soon, respectively.

HISTORY, DEVELOPMENT AND REORGANISATION

- (6) Since the beginning of the Track Record Period and up to immediately before Reorganisation, SCCM was owned as to 70% and 30% by SB Soon and CA Soon, respectively.
- (7) Since the beginning of the Track Record Period and up to immediately before Reorganisation, Chop Chin Huat was owned as to approximately 82% and 18% by SB Soon and ML Ng, respectively.
- (8) Since the beginning of the Track Record Period and up to immediately before Reorganisation, SCC Logistics was owned as to 60% and 40% by Ms. Yap and Mr. Sang, respectively, both of whom held the shares on trust for and on behalf of SB Soon, CA Soon and SL Soon. For details of the trust arrangement, please refer to the paragraph “Establishment and development of the subsidiaries of our Company – (10) SCC Logistics” in this section.
- (9) Since the beginning of the Track Record Period and up to immediately before Reorganisation, NSB Marketing was owned as to approximately 90% and 10% by SB Soon and ML Ng, respectively.
- (10) Since the beginning of the Track Record Period and up to immediately before Reorganisation, EC Maju Frozen was owned as to 70% and 30% by SB Soon and SL Soon, respectively.

PARTIES ACTING IN CONCERT

Over the course of our business history, the Soon Siblings, CH Tan and ML Ng who are members of the Soon Family, were either directors and/or shareholders of SCCSB, SCC Seafood, SCCM Pahang, SCCM East Coast, SCCM, Chop Chin Huat and/or SCC Logistics (the “**Relevant Companies**”). Each of the Soon Siblings, CH Tan and ML Ng had, in exercising and implementing the management and operation of these Relevant Companies, been acting in concert with each other. As the Relevant Companies were a group of private entities in the past, these arrangements were not formalized in writing and each of the Soon Siblings, CH Tan and ML Ng was content with these arrangements based on their close and long-term business and family relationship, as well as the trust and confidence they have in each other. In preparation for the [REDACTED], the Soon Siblings, CH Tan and ML Ng entered into the Concert Party Confirmatory Deed on 9 February 2021, details of which are set out in the section headed “Relationship with Our Controlling Shareholders – Concert Parties Confirmatory Deed” in this document.

Corporate restructuring

In preparation for the [REDACTED], our Company was incorporated in the Cayman Islands and the companies comprising our Group have undergone a group reorganisation to rationalise our Group structure. The Reorganisation involved the following steps:

- (1) On 27 December 2018, Soon Holdings was incorporated in BVI with limited liability and was authorised to issue a maximum of 50,000 shares of a single class each with a par value of US\$1.00. On the same date, Soon Holdings allotted and issued as fully paid at par seven shares to SB Soon and one share to each of CA Soon, SL Soon and LS Soon, respectively. After the said allotment of shares, Soon Holdings was owned as to 70% by SB Soon and 10% by each of CA Soon, SL Soon and LS Soon. The shareholding structure of Soon Holdings was determined (i) in anticipation of the Reorganisation; and (ii) with reference to the shareholding interests of the Soon Siblings in the subsidiaries of our Group and the valuation of such subsidiaries.

HISTORY, DEVELOPMENT AND REORGANISATION

- (2) On 27 December 2018, SCC Holdings was incorporated in BVI with limited liability. For details of SCC Holdings, please refer to the paragraph headed “Establishment and development of the subsidiaries of our Company – SCC Holdings” in this section.
- (3) On 17 December 2018, SCC Holding Malaysia was incorporated in Malaysia with limited liability. For further details of SCC Holding Malaysia, please refer to the paragraph headed “Establishment and development of the subsidiaries of our Company – SCC Holding Malaysia” in this section.
- (4) On 29 January 2019, SCC HK was incorporated in Hong Kong with limited liability. For details of SCC HK, please refer to the paragraph headed “Establishment and development of the subsidiaries of our Company – SCC HK” in this section.
- (5) On 14 February 2019, our Company was incorporated in the Cayman Islands as an exempted company with limited liability. As at the date of incorporation, our Company had an authorised share capital of HK\$380,000 divided into 38,000,000 ordinary shares of par value of HK\$0.01 each, of which one Share was allotted and issued as fully paid to an independent initial subscriber at par, which was then transferred to Soon Holdings at par on the same day. On the same day, our Company allotted and issued as fully paid 99 Shares to Soon Holdings at par.
- (6) On 26 December 2018, SCC Holding Malaysia acquired 780,000 shares, 150,000 shares, 375,000 shares and 195,000 shares in SCCSB from SB Soon, LS Soon, CH Tan and CA Soon, at the nominal consideration of RM1.00, respectively. The above transfers were properly and legally completed and settled. After the said transfers, SCCSB became a wholly-owned subsidiary of SCC Holding Malaysia.
- (7) On 26 December 2018, SCC Holding Malaysia acquired 780,000 shares, 135,000 shares, 450,000 shares and 135,000 shares in SCC Seafood from SB Soon, LS Soon, SL Soon and CA Soon, at the nominal consideration of RM1.00, respectively. The above transfers were properly and legally completed and settled. After the said transfers, SCC Seafood became a wholly-owned subsidiary of SCC Holding Malaysia.
- (8) On 26 December 2018, SCC Holding Malaysia acquired 260,000 shares, 45,000 shares and 195,000 shares in SCCM Pahang from SB Soon, SL Soon and CA Soon, at the nominal consideration of RM1.00, respectively. The above transfers were properly and legally completed and settled. After the said transfers, SCCM Pahang became a wholly-owned subsidiary of SCC Holding Malaysia.

HISTORY, DEVELOPMENT AND REORGANISATION

- (9) On 26 December 2018, SCC Holding Malaysia acquired 25,000 shares and 25,000 shares in SCCM East Coast from SB Soon and CA Soon, at the nominal consideration of RM1.00, respectively. The above transfers were properly and legally completed and settled. After the said transfers, SCCM East Coast became a wholly-owned subsidiary of SCC Holding Malaysia.
- (10) On 26 December 2018, SCC Holding Malaysia acquired 700,000 shares and 300,000 shares in SCCM from SB Soon and CA Soon, at the nominal consideration of RM1.00, respectively. The above transfers were properly and legally completed and settled. After the said transfers, SCCM became a wholly-owned subsidiary of SCC Holding Malaysia.
- (11) On 26 December 2018, SCC Holding Malaysia acquired 410,000 shares and 90,000 shares in Chop Chin Huat from SB Soon and ML Ng, at the nominal consideration of RM1.00, respectively. The above transfers were properly and legally completed and settled. After the said transfers, Chop Chin Huat became a wholly-owned subsidiary of SCC Holding Malaysia.
- (12) On 26 December 2018, at the direction of SB Soon, CA Soon and SL Soon (as the case may be), Mr. Sang and Ms. Yap transferred 200,000 shares and 300,000 shares in SCC Logistics, at the nominal consideration of RM1.00, respectively, to SCC Holding Malaysia. The above transfers were properly and legally completed and settled. After the said transfers, SCC Logistics became a wholly-owned subsidiary of SCC Holding Malaysia.
- (13) On 26 December 2018, SCC Holding Malaysia acquired 270,000 shares and 30,000 shares in NSB Marketing from SB Soon and ML Ng, at the nominal consideration of RM1.00, respectively. The above transfers were properly and legally completed and settled. After the said transfers, NSB Marketing became a wholly-owned subsidiary of SCC Holding Malaysia.
- (14) On 26 December 2018, SCC Holding Malaysia acquired 35,000 shares and 15,000 shares in EC Maju Frozen from SB Soon and SL Soon, at the nominal consideration of RM1.00, respectively. The above transfers were properly and legally completed and settled. After the said transfers, EC Maju Frozen became a wholly-owned subsidiary of SCC Holding Malaysia.
- (15) Given that NSB Marketing had ceased operation, in order to streamline the corporate structure of our Group, SCC Holding Malaysia disposed of the entire equity interest of NSB Marketing to SB Soon at the nominal consideration of RM100 on 31 December 2020, as deemed distribution arising from Reorganisation prior to the [REDACTED]. For further information about NSB Marketing and its disposal, please refer to the paragraphs headed “History, development and Reorganisation – Disposal of subsidiaries – NSB Marketing”.

HISTORY, DEVELOPMENT AND REORGANISATION

- (16) Given that the Controlling Shareholders were of the opinion that it was more beneficial to focus their financial resources in the distribution and sales business in Malaysia, in order to streamline the corporate structure of our Group and to focus on our core business, SCC Holding Malaysia disposed of the entire equity interest of EC Maju Frozen to an Independent Third Party at the consideration of RM400,000 on 31 December 2020. The consideration was arrived at after arm’s length negotiation between the parties thereto and taking into account the profitability and business prospect of EC Maju Frozen, in particular the loss of approximately RM0.02 million in FY2019 (based on its local audited report for FY2019) and its negative performance around 2020. For further information about EC Maju Frozen and its disposal, please refer to the paragraphs headed “History, development and Reorganisation – Disposal of subsidiaries – EC Maju Frozen”.
- (17) On 21 January 2021, pursuant to the Reorganisation Agreement, our Company acquired all the issued shares of SCC Holdings from Soon Holdings. In consideration thereof, our Company allotted and issued 100 Shares credited as fully paid to Soon Holdings. After the said transfer, SCC Holdings became a wholly-owned subsidiary of our Company. The above transfers were properly and legally completed and settled.

All of the share transfers mentioned above in this section have been properly and legally completed and settled.

HISTORY, DEVELOPMENT AND REORGANISATION

Upon completion of the Reorganisation set out above, our Company became the holding company of our Group. The following chart sets out the shareholding and corporate structure of our Group immediately after the Reorganisation but prior to completion of the [REDACTED] and the Capitalisation Issue:

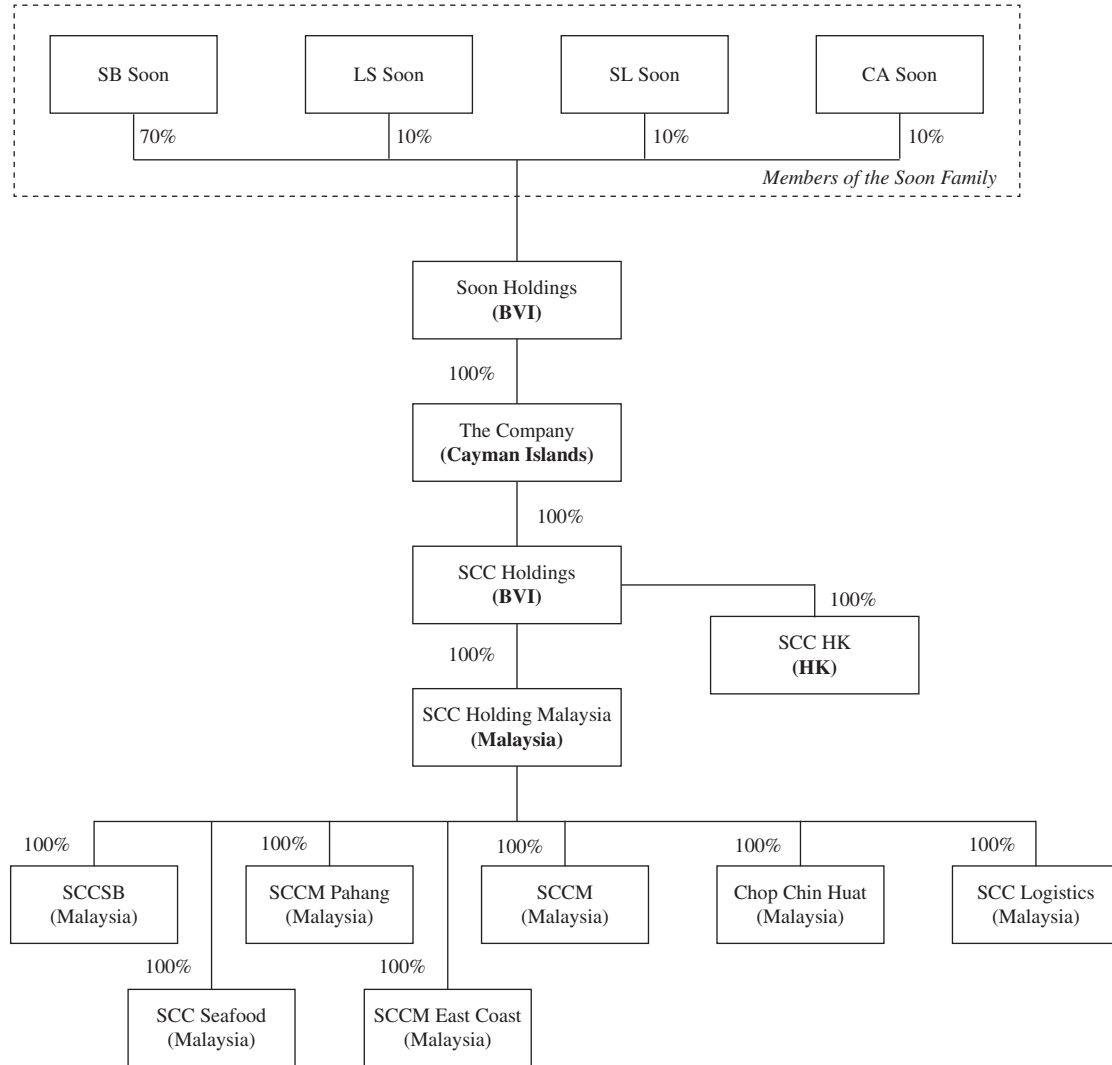

Conditional upon the share premium account of our Company having sufficient balance, or otherwise being credited as a result of the issue of new Shared pursuant to the [REDACTED], an amount standing to the credit of the share premium account of our Company will be capitalised and applied in paying up in full at par such number of Shares for allotment and issue to Soon Holdings prior to the commencement of the [REDACTED] and [REDACTED] of the Shares on the Stock Exchange, so that the number of Shares so allotted and issued, when aggregated with the number of Shares already owned by Soon Holdings, will constitute not more than [REDACTED]% of the enlarged issued share capital of our Company (without taking into account the [REDACTED] and any Shares which may be allotted and issued upon the exercise of any options which may be granted under the Share Option Scheme).

HISTORY, DEVELOPMENT AND REORGANISATION

The following chart sets forth the shareholding structure of our Group immediately following the completion of the Capitalisation Issue and the [REDACTED] (without taking into account any Shares which may be issued upon the exercise of the [REDACTED] or any options that may be granted under the Share Option Scheme:

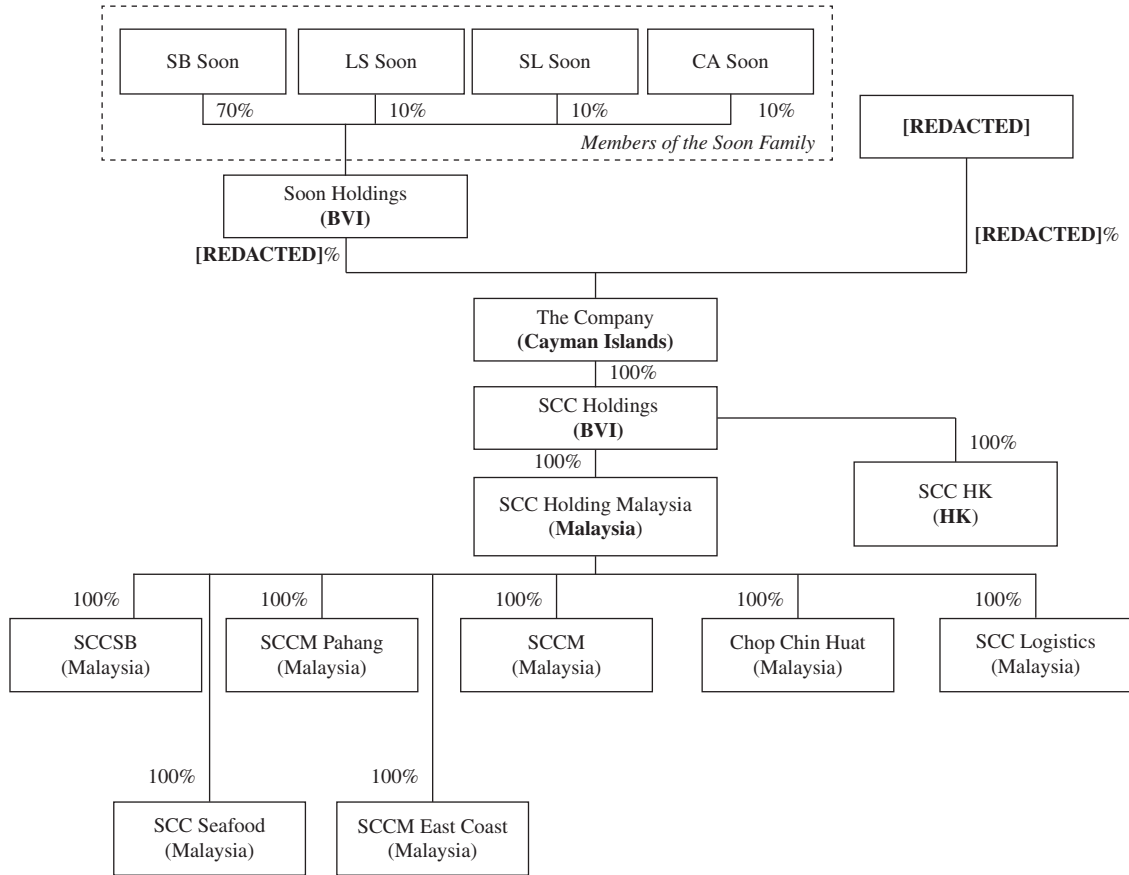

Compliance with applicable laws and regulations

Our Company’s legal advisers as to Cayman Islands laws and Malaysia laws confirmed that we have obtained all necessary approvals for effecting the Reorganisation from the relevant authorities and that the Reorganisation complied with applicable laws and regulations pursuant to HKEX Guidance Letter HKEX-GL86-16 issued by the Stock Exchange.